



Report of Test

LLIA000998-001A-R01*

*This test report supersedes test report LLIA000998-001

Catalog Number: ML3WL-D-HO-ASY-K35-4-X-VR-X
Pendant mounted, extruded aluminum housing, formed white enamel aluminum reflector tray, frosted plastic enclosure.
120 White LEDs, two Osram PrevaLED Line boards with 60 LEDs each, prismatic plastic optics below.
One Osram Optotronic OTi 50/120-277/1A 4 DIM L LED driver labeled as 600mA.
120.0Vac, 60.00Hz, 0.2472A, 29.55W, 0.996PF, 6.1%THD(i)

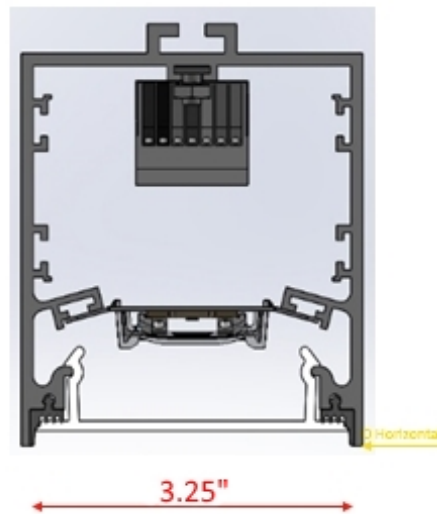

Performance Summary

Total Light Output	2578 lm
Luminaire Power	29.5 W
Luminous Efficacy	87.4 lm/W

PREPARED FOR : Precision Architectural Lighting, 4830 Timber Creek Drive, Houston, TX 77017



Test Report No. LLIA000998-001A-R01

Catalog Number: ML3WL-D-HO-ASY-K35-4-X-VR-X

Pendant mounted, extruded aluminum housing, formed white enamel aluminum reflector tray, frosted plastic enclosure.

120 White LEDs, two Osram PrevaLED Line boards with 60 LEDs each, prismatic plastic optics below.

One Osram Optotronic OTi 50/120-277/1A 4 DIM L LED driver labeled as 600mA.

120.0Vac, 60.00Hz, 0.2472A, 29.55W, 0.996PF, 6.1%THD(i)

Legend: C0/C180-Black, C45/C225-Green, C90/C270-Blue (cd)

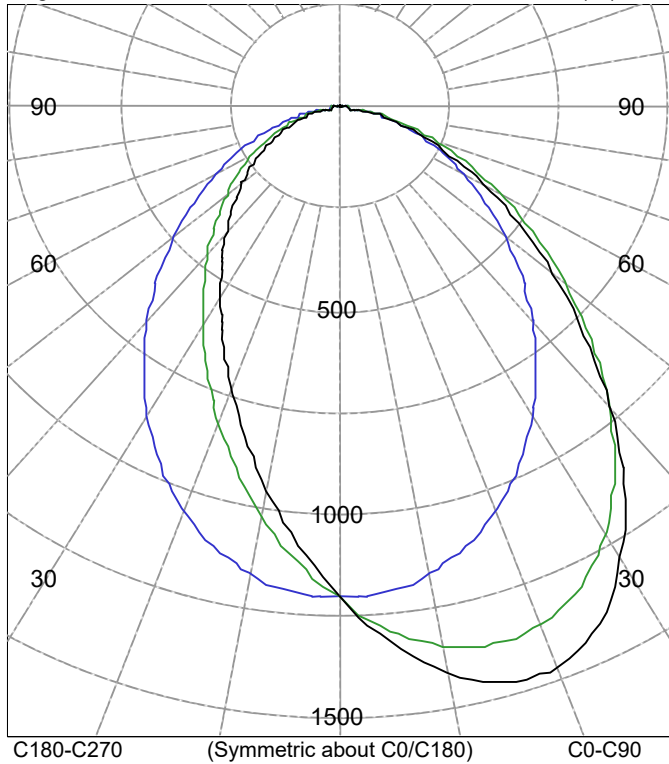

INTENSITY SUMMARY (cd)

Gamma	C-Plane					Flux (lm)
	C0	C22.5	C45	C67.5	C90	
0.0	1207	1207	1207	1207	1207	
5.0	1321	1315	1290	1236	1197	114
10.0	1412	1396	1343	1250	1166	
15.0	1465	1441	1366	1239	1117	319
20.0	1462	1436	1352	1201	1050	
25.0	1400	1377	1298	1139	969	458
30.0	1282	1268	1207	1054	878	
35.0	1127	1124	1088	951	781	499
40.0	956	962	951	837	681	
45.0	788	799	808	719	583	453
50.0	632	647	668	603	490	
55.0	497	511	536	494	404	355
60.0	379	394	418	394	325	
65.0	277	291	313	301	252	237
70.0	191	202	222	216	184	
75.0	116	125	142	142	122	118
80.0	54	60	74	78	69	
85.0	7	9	18	28	27	23
90.0	0	0	0	0	0	

ZONAL FLUX AND PERCENTAGES

Zone	Flux (lm)	% Lamp	% Luminaire
0-30	891	N / A	34.6
0-40	1391	N / A	53.9
0-60	2199	N / A	85.3
0-90	2578	N / A	100.0
40-90	1187	N / A	46.1
60-90	379	N / A	14.7
90-180	0	N / A	0.0
0-180	2578	N / A	100.0

Total Light Output = 2,578 lm

Signed:

Authorized Signatory

Date of test

12-Jul-2018

Date of report

16-Jun-2020



Test Report No. LLIA000998-001A-R01

Catalog Number: ML3WL-D-HO-ASY-K35-4-X-VR-X

Pendant mounted, extruded aluminum housing, formed white enamel aluminum reflector tray, frosted plastic enclosure.

120 White LEDs, two Osram PrevaLED Line boards with 60 LEDs each, prismatic plastic optics below.

One Osram Optotronic OTi 50/120-277/1A 4 DIM L LED driver labeled as 600mA.

120.0Vac, 60.00Hz, 0.2472A, 29.55W, 0.996PF, 6.1%THD(i)

Intensity data (cd)

Gamma	C-Plane				
	C0	C22.5	C45	C67.5	C90
0.0	1207	1207	1207	1207	1207
2.5	1266	1265	1254	1221	1205
5.0	1321	1315	1290	1236	1197
7.5	1370	1359	1320	1246	1184
10.0	1412	1396	1343	1250	1166
12.5	1444	1424	1358	1248	1143
15.0	1465	1441	1366	1239	1117
17.5	1471	1445	1364	1223	1086
20.0	1462	1436	1352	1201	1050
22.5	1438	1413	1329	1174	1011
25.0	1400	1377	1298	1139	969
27.5	1346	1328	1257	1099	925
30.0	1282	1268	1207	1054	878
32.5	1208	1199	1151	1004	830
35.0	1127	1124	1088	951	781
37.5	1042	1044	1022	895	731
40.0	956	962	951	837	681
42.5	871	880	880	778	631
45.0	788	799	808	719	583
47.5	708	722	737	660	536
50.0	632	647	668	603	490
52.5	562	577	600	548	446
55.0	497	511	536	494	404
57.5	436	450	475	443	364
60.0	379	394	418	394	325
62.5	326	340	363	346	287
65.0	277	291	313	301	252
67.5	232	244	266	257	217
70.0	191	202	222	216	184
72.5	152	163	180	178	152
75.0	116	125	142	142	122
77.5	83	91	106	109	94
80.0	54	60	74	78	69
82.5	28	33	44	51	46
85.0	7	9	18	28	27
87.5	1	1	2	8	12
90.0	0	0	0	0	0



Test Report No. LLIA000998-001A-R01

Catalog Number: ML3WL-D-HO-ASY-K35-4-X-VR-X

Pendant mounted, extruded aluminum housing, formed white enamel aluminum reflector tray, frosted plastic enclosure.

120 White LEDs, two Osram PrevaLED Line boards with 60 LEDs each, prismatic plastic optics below.

One Osram Optotronic OTi 50/120-277/1A 4 DIM L LED driver labeled as 600mA.

120.0Vac, 60.00Hz, 0.2472A, 29.55W, 0.996PF, 6.1%THD(i)

Intensity data (cd)

Gamma	C-Plane				
	C0	C22.5	C45	C67.5	C90
90.0	0	0	0	0	0
92.5	0	0	0	0	0
95.0	0	0	0	0	0
97.5	0	0	0	0	0
100.0	0	0	0	0	0
102.5	0	0	0	0	0
105.0	0	0	0	0	0
107.5	0	0	0	0	0
110.0	0	0	0	0	0
112.5	0	0	0	0	0
115.0	0	0	0	0	0
117.5	0	0	0	0	0
120.0	0	0	0	0	0
122.5	0	0	0	0	0
125.0	0	0	0	0	0
127.5	0	0	0	0	0
130.0	0	0	0	0	0
132.5	0	0	0	0	0
135.0	0	0	0	0	0
137.5	0	0	0	0	0
140.0	0	0	0	0	0
142.5	0	0	0	0	0
145.0	0	0	0	0	0
147.5	0	0	0	0	0
150.0	0	0	0	0	0
152.5	0	0	0	0	0
155.0	0	0	0	0	0
157.5	0	0	0	0	0
160.0	0	0	0	0	0
162.5	0	0	0	0	0
165.0	0	0	0	0	0
167.5	0	0	0	0	0
170.0	0	0	0	0	0
172.5	0	0	0	0	0
175.0	0	0	0	0	0
177.5	0	0	0	0	0
180.0	0	0	0	0	0



Test Report No. LLIA000998-001A-R01

Catalog Number: ML3WL-D-HO-ASY-K35-4-X-VR-X

Pendant mounted, extruded aluminum housing, formed white enamel aluminum reflector tray, frosted plastic enclosure.

120 White LEDs, two Osram PrevaLED Line boards with 60 LEDs each, prismatic plastic optics below.

One Osram Optotronic OTi 50/120-277/1A 4 DIM L LED driver labeled as 600mA.

120.0Vac, 60.00Hz, 0.2472A, 29.55W, 0.996PF, 6.1%THD(i)

Intensity data (cd)

Gamma	C-Plane				
	C90	C112.5	C135	C157.5	C180
0.0	1207	1207	1207	1207	1207
2.5	1205	1173	1168	1153	1139
5.0	1197	1144	1121	1095	1078
7.5	1184	1111	1071	1036	1017
10.0	1166	1075	1021	977	956
12.5	1143	1036	969	919	896
15.0	1117	994	917	862	838
17.5	1086	950	865	806	782
20.0	1050	905	814	753	728
22.5	1011	859	764	701	678
25.0	969	813	715	653	630
27.5	925	766	669	607	585
30.0	878	720	624	564	543
32.5	830	675	582	524	504
35.0	781	630	541	486	468
37.5	731	587	503	450	434
40.0	681	545	466	417	402
42.5	631	505	431	385	371
45.0	583	466	398	355	343
47.5	536	429	367	327	316
50.0	490	394	337	300	289
52.5	446	360	307	274	264
55.0	404	328	279	249	240
57.5	364	297	252	225	217
60.0	325	266	226	201	194
62.5	287	237	200	179	173
65.0	252	208	176	157	151
67.5	217	180	152	136	130
70.0	184	152	129	115	110
72.5	152	126	107	95	91
75.0	122	101	85	76	72
77.5	94	78	65	58	55
80.0	69	57	47	41	39
82.5	46	38	31	26	24
85.0	27	21	16	12	11
87.5	12	8	3	1	1
90.0	0	0	0	0	0



Test Report No. LLIA000998-001A-R01

Catalog Number: ML3WL-D-HO-ASY-K35-4-X-VR-X

Pendant mounted, extruded aluminum housing, formed white enamel aluminum reflector tray, frosted plastic enclosure.

120 White LEDs, two Osram PrevaLED Line boards with 60 LEDs each, prismatic plastic optics below.

One Osram Optotronic OTi 50/120-277/1A 4 DIM L LED driver labeled as 600mA.

120.0Vac, 60.00Hz, 0.2472A, 29.55W, 0.996PF, 6.1%THD(i)

Intensity data (cd)

Gamma	C-Plane				
	C90	C112.5	C135	C157.5	C180
90.0	0	0	0	0	0
92.5	0	0	0	0	0
95.0	0	0	0	0	0
97.5	0	0	0	0	0
100.0	0	0	0	0	0
102.5	0	0	0	0	0
105.0	0	0	0	0	0
107.5	0	0	0	0	0
110.0	0	0	0	0	0
112.5	0	0	0	0	0
115.0	0	0	0	0	0
117.5	0	0	0	0	0
120.0	0	0	0	0	0
122.5	0	0	0	0	0
125.0	0	0	0	0	0
127.5	0	0	0	0	0
130.0	0	0	0	0	0
132.5	0	0	0	0	0
135.0	0	0	0	0	0
137.5	0	0	0	0	0
140.0	0	0	0	0	0
142.5	0	0	0	0	0
145.0	0	0	0	0	0
147.5	0	0	0	0	0
150.0	0	0	0	0	0
152.5	0	0	0	0	0
155.0	0	0	0	0	0
157.5	0	0	0	0	0
160.0	0	0	0	0	0
162.5	0	0	0	0	0
165.0	0	0	0	0	0
167.5	0	0	0	0	0
170.0	0	0	0	0	0
172.5	0	0	0	0	0
175.0	0	0	0	0	0
177.5	0	0	0	0	0
180.0	0	0	0	0	0



Test Number: LLIA000998-001A-R01

Catalog Number: ML3WL-D-HO-ASY-K35-4-X-VR-X

Pendant mounted, extruded aluminum housing, formed white enamel aluminum reflector tray, frosted plastic enclosure.

120 White LEDs, two Osram PrevaLED Line boards with 60 LEDs each, prismatic plastic optics below.

One Osram Optotronic OTi 50/120-277/1A 4 DIM L LED driver labeled as 600mA.

120.0Vac, 60.00Hz, 0.2472A, 29.55W, 0.996PF, 6.1%THD(i)

Coefficients Of Utilization - Zonal Cavity Method

Effective Floor Cavity Reflectance 0.20

RC	80				70				50			30			10			0
	70	50	30	10	70	50	30	10	50	30	10	50	30	10	50	30	10	0
0	119	119	119	119	116	116	116	116	111	111	111	106	106	106	102	102	102	100
1	110	106	102	99	107	104	100	97	99	97	94	95	93	91	92	90	88	86
2	101	94	87	82	99	92	86	81	88	84	79	85	81	78	82	79	76	74
3	93	83	76	70	91	82	75	69	79	73	68	76	71	67	74	69	66	64
4	86	75	66	60	83	73	66	60	71	64	59	69	63	58	66	62	58	56
5	79	67	59	53	77	66	58	52	64	57	52	62	56	51	60	55	51	49
6	74	61	53	47	72	60	52	46	58	51	46	57	50	46	55	50	45	43
7	68	56	47	42	67	55	47	42	53	46	41	52	46	41	51	45	41	39
8	64	51	43	38	62	50	43	37	49	42	37	48	42	37	47	41	37	35
9	60	47	39	34	59	47	39	34	45	39	34	44	38	34	43	38	34	32
10	56	44	36	31	55	43	36	31	42	36	31	41	35	31	40	35	31	29

For absolute test reports, CUs are expressed as a percentage of total lumen output. Calculations were based on published IES procedures, and are based on the zonal cavity method. Basic assumptions: 1) Room surfaces are lambertian reflectors. 2) Incident flux on each surface is uniformly distributed. 3) The room is spectrally neutral. When luminaires are not evenly distributed throughout the room, or do not exhibit lateral symmetry, CU values may differ from actual performance.

Circle of Light Plot

Height(ft)	Illuminance at Nadir (fc)	Beam Width (across 50% Nadir Illum)	
		0-180	90-270
6.0	33.5	6.45	6.62
8.0	18.9	8.60	8.83
10.0	12.1	10.75	11.04
12.0	8.4	12.90	13.24
14.0	6.2	15.05	15.45
16.0	4.7	17.20	17.66

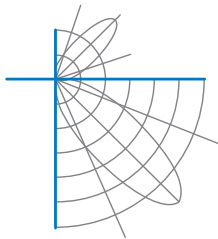

Report of Test

LLIA000998-001A-R01

LCS Tables and Bug Classification

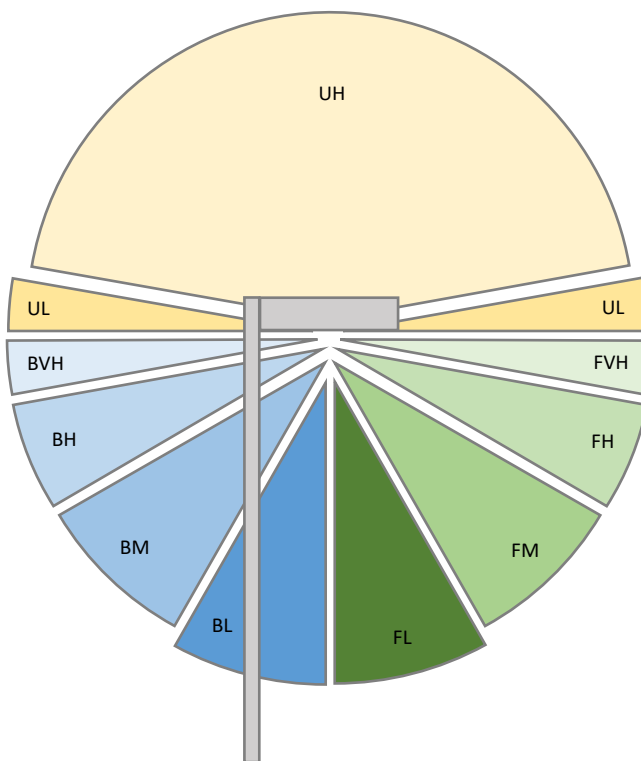

Back Light

BL - Back Low (0°-30°)	354.9 Lm
BM - Back Mid (30°-60°)	472.8 Lm
BH - Back High (60°-80°)	139.8 Lm
BVH - Back Very High (80°-90°)	10.5 Lm

Forward Light

FL - Forward Low (0°-30°)	536.4 Lm
FM - Forward Mid (30°-60°)	834.6 Lm
FH - Forward High (60°-80°)	215.9 Lm
FVH - Forward Very High (80°-90°)	12.9 Lm

Uplight

UL - Upward Low (90°-100°)	0.0 Lm
UH - Upward High (100°-180°)	0.0 Lm

BUG Ratings: B1 - U0 - G1



Test Report No. LLIA000998-001A-R01

Catalog Number: ML3WL-D-HO-ASY-K35-4-X-VR-X

Pendant mounted, extruded aluminum housing, formed white enamel aluminum reflector tray, frosted plastic enclosure.

120 White LEDs, two Osram PrevaLED Line boards with 60 LEDs each, prismatic plastic optics below.

One Osram Optotronic OTi 50/120-277/1A 4 DIM L LED driver labeled as 600mA.

120.0Vac, 60.00Hz, 0.2472A, 29.55W, 0.996PF, 6.1%THD(i)

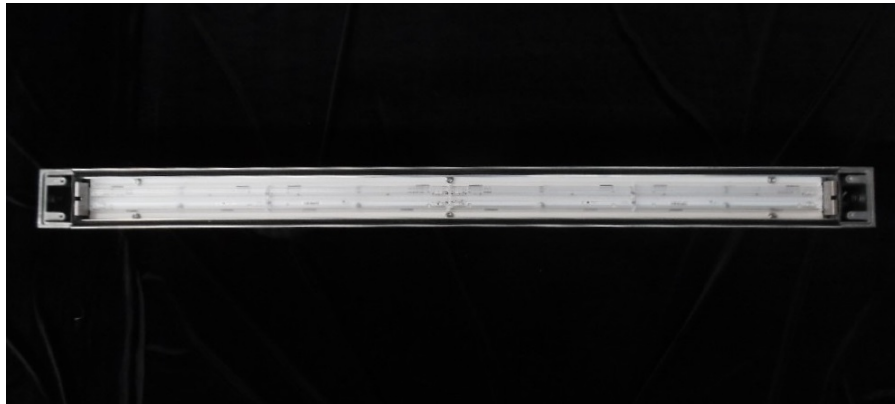



Test Report No. LLIA000998-001A-R01

Catalog Number: ML3WL-D-HO-ASY-K35-4-X-VR-X

Pendant mounted, extruded aluminum housing, formed white enamel aluminum reflector tray, frosted plastic enclosure.

120 White LEDs, two Osram PrevaLED Line boards with 60 LEDs each, prismatic plastic optics below.

One Osram Optotronic OTi 50/120-277/1A 4 DIM L LED driver labeled as 600mA.

120.0Vac, 60.00Hz, 0.2472A, 29.55W, 0.996PF, 6.1%THD(i)

Test Distance 9.5 m
Test Temperature 25.6 °C

Notes The laboratory has not participated in the selection of samples to be tested. All testing is performed on the understanding that the significance of the report is limited to the extent that the test sample is representative of production units.

Tested in accordance with the applicable sections of publications: IES LM-79-08 (Sec. 12), IES LM-16-93, IES LM-58-13, CIE 13.3:1995, CIE 15:2004, ANSI C78.377:2015, ANSI C82.77-10:2014.

The luminous intensity values, and other derived quantities, contained in this report are based on the absolute data, as measured.

Prorating the performance of the sample for the use of other component combinations (such as lamp / LED / Ballast / driver), or for use in different environmental conditions than that tested, may produce erroneous results.

This report is free of erasures and corrections.

Photometric intensity values are reported using the CIE Gamma coordinate system as defined in CIE publication number 121.

This report may contain data that are not covered by the NVLAP accreditation. Quantities marked with * are not covered.

This report must not be used by the customer to claim product certification, approval or endorsement by NVLAP, NIST, or any agency of the Federal Government.

Revision Added LCS Tables and Bug Classification page per customer request.



Report of Test

LLIA000998-001B-R01*

Integrating Sphere Report

Catalog Number: ML3WL-D-HO-ASY-K35-4-X-VR-X

Pendant mounted, extruded aluminum housing, formed white enamel aluminum reflector tray, frosted plastic enclosure.

120 White LEDs, two Osram PrevaLED Line boards with 60 LEDs each, prismatic plastic optics below.

One Osram Optotronic OTi 50/120-277/1A 4 DIM L LED driver labeled as 600mA.



Performance Summary

Voltage	120.0 Vac
Current	0.2471 A
Power	29.55 W
Frequency	59.97 Hz
Power Factor	0.996
Current THD	6.1 %

Total Luminous Flux	2669.0 lm
Efficacy	90.3 lm/W
Chromaticity (x,y)	(0.4054, 0.3884)
(u',v')	(0.2367, 0.5103)
Duv	-0.0010
CCT	3480 K
CRI (Ra)	83
R9	17
TM-30: Rf	82
TM-30: Rg	98

Prepared For:

Precision Architectural Lighting
4830 Timber Creek Drive
Houston, TX 77017, USA

*This test report supersedes test report LLIA000998-001B

Test date: 07/11/2018

Report date: 06/16/2020

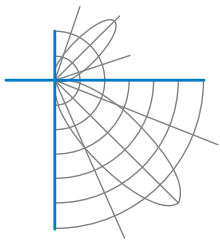

Test Report Number: LLIA000998-001B-R01

Catalog Number: ML3WL-D-HO-ASY-K35-4-X-VR-X

Pendant mounted, extruded aluminum housing, formed white enamel aluminum reflector tray, frosted plastic enclosure.

120 White LEDs, two Osram PrevaLED Line boards with 60 LEDs each, prismatic plastic optics below.

One Osram Optotronic OTi 50/120-277/1A 4 DIM L LED driver labeled as 600mA.

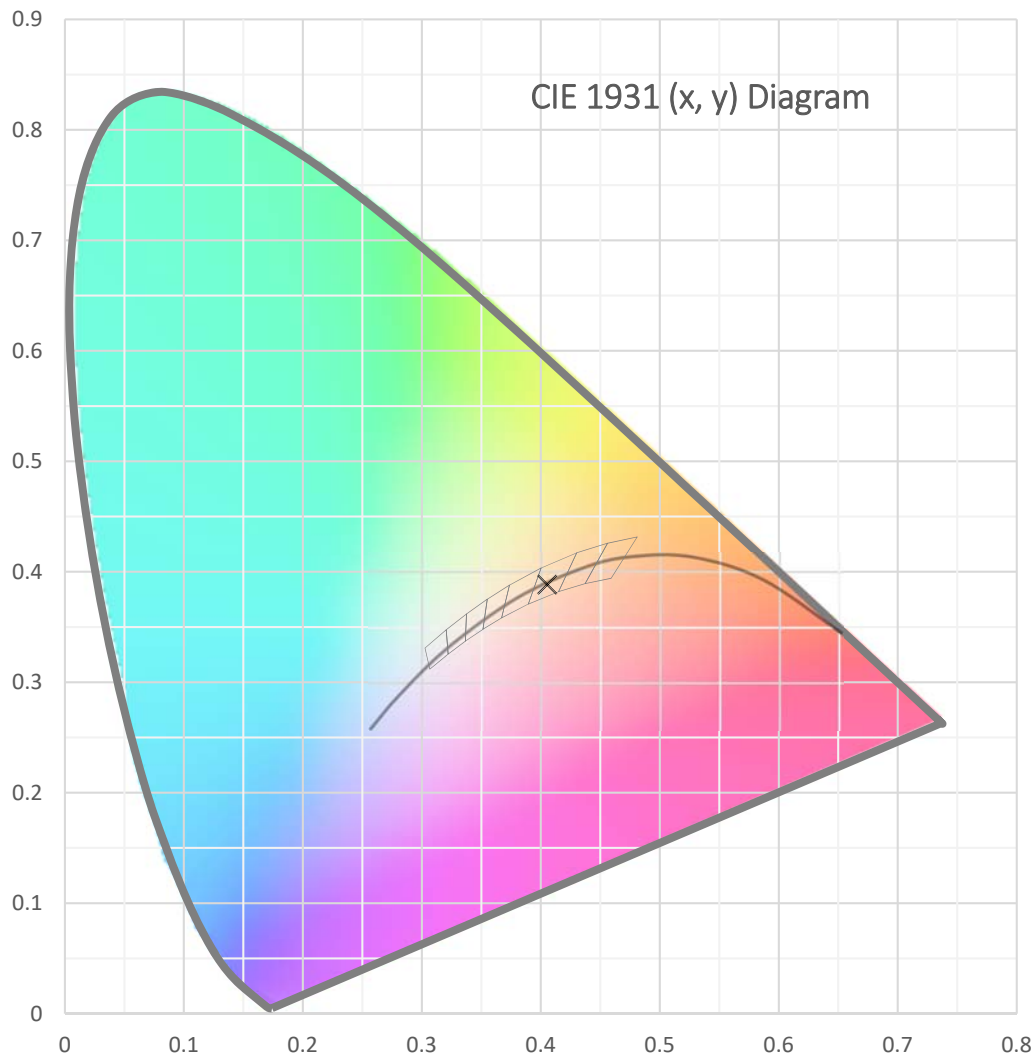

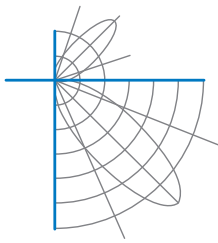

Test Report Number: LLIA000998-001B-R01

Catalog Number: ML3WL-D-HO-ASY-K35-4-X-VR-X

Pendant mounted, extruded aluminum housing, formed white enamel aluminum reflector tray, frosted plastic enclosure.

120 White LEDs, two Osram PrevaLED Line boards with 60 LEDs each, prismatic plastic optics below.

One Osram Optotronic OTi 50/120-277/1A 4 DIM L LED driver labeled as 600mA.

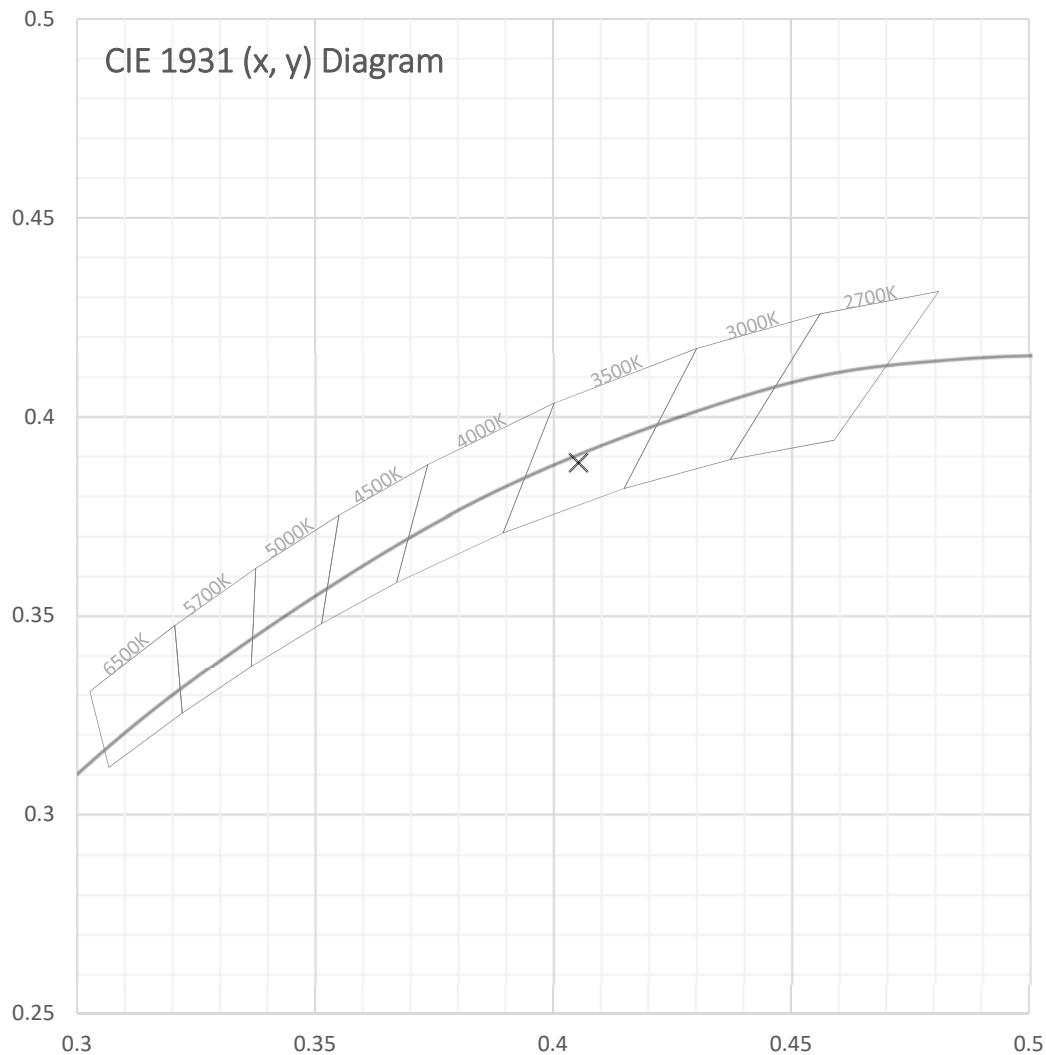



Test Report Number: LLIA000998-001B-R01

Catalog Number: ML3WL-D-HO-ASY-K35-4-X-VR-X

Pendant mounted, extruded aluminum housing, formed white
enamel aluminum reflector tray, frosted plastic enclosure.

120 White LEDs, two Osram PrevaLED Line boards with 60 LEDs each, prismatic plastic optics below.

One Osram Optotronic OTi 50/120-277/1A 4 DIM L LED driver labeled as 600mA.

Spectral Data	Total Radiant Flux	8.282 W
	Total Luminous Flux	2669.0 Lm
	Chromaticity CIE 1931 (x, y)	(0.4054, 0.3884)
	Chromaticity CIE 1976 (u', v')	(0.2367, 0.5103)
	Correlated Color Temperature (CCT)	3480 K
	Color Rendering Index (Ra)	83
	R1	82
	R2	89
	R3	94
	R4	83
	R5	82
	R6	84
	R7	86
	R8	66
	R9	17
	R10	73
	R11	81
	R12	63
	R13	83
	R14	96
	TM-30: Rf	82
	TM-30: Rg	98
	Distance from Planckian Locus (Duv)	-0.0010
	Scotopic/Photopic Ratio *	1.496

Electrical Data

Voltage	120.0 Vac
Current	0.2471 A
Power	29.55 W
Frequency	59.97 Hz
Power Factor	0.996
Current THD	6.1 %



Test Report Number: LLIA000998-001B-R01

Catalog Number: ML3WL-D-HO-ASY-K35-4-X-VR-X

Pendant mounted, extruded aluminum housing, formed white
enamel aluminum reflector tray, frosted plastic enclosure.

120 White LEDs, two Osram PrevaLED Line boards with 60 LEDs each, prismatic plastic optics below.

One Osram Optotronic OTi 50/120-277/1A 4 DIM L LED driver labeled as 600mA.

Summary Spectral Power Distribution (wavelength - nm, spectral power - mW)

380	0.000256	480	0.009156	580	0.045323	680	0.012979
385	0.000288	485	0.009713	585	0.046746	685	0.011917
390	0.000376	490	0.011264	590	0.047862	690	0.010919
395	0.000490	495	0.013978	595	0.048468	695	0.009847
400	0.000645	500	0.017494	600	0.048478	700	0.008742
405	0.000840	505	0.020921	605	0.047831	705	0.007632
410	0.001126	510	0.024052	610	0.047112	710	0.006618
415	0.001579	515	0.026596	615	0.046211	715	0.005773
420	0.002457	520	0.028653	620	0.044900	720	0.004996
425	0.004007	525	0.030196	625	0.043141	725	0.004313
430	0.006866	530	0.031534	630	0.040977	730	0.003710
435	0.011408	535	0.032694	635	0.038498	735	0.003187
440	0.018623	540	0.033774	640	0.035548	740	0.002726
445	0.030647	545	0.035031	645	0.032638	745	0.002353
450	0.043050	550	0.036221	650	0.029810	750	0.002031
455	0.038957	555	0.037547	655	0.026859	755	0.001751
460	0.025652	560	0.038969	660	0.023741	760	0.001516
465	0.018619	565	0.040423	665	0.020325	765	0.001306
470	0.014162	570	0.042140	670	0.017026	770	0.001124
475	0.010432	575	0.043814	675	0.014581	775	0.000971
						780	0.000836

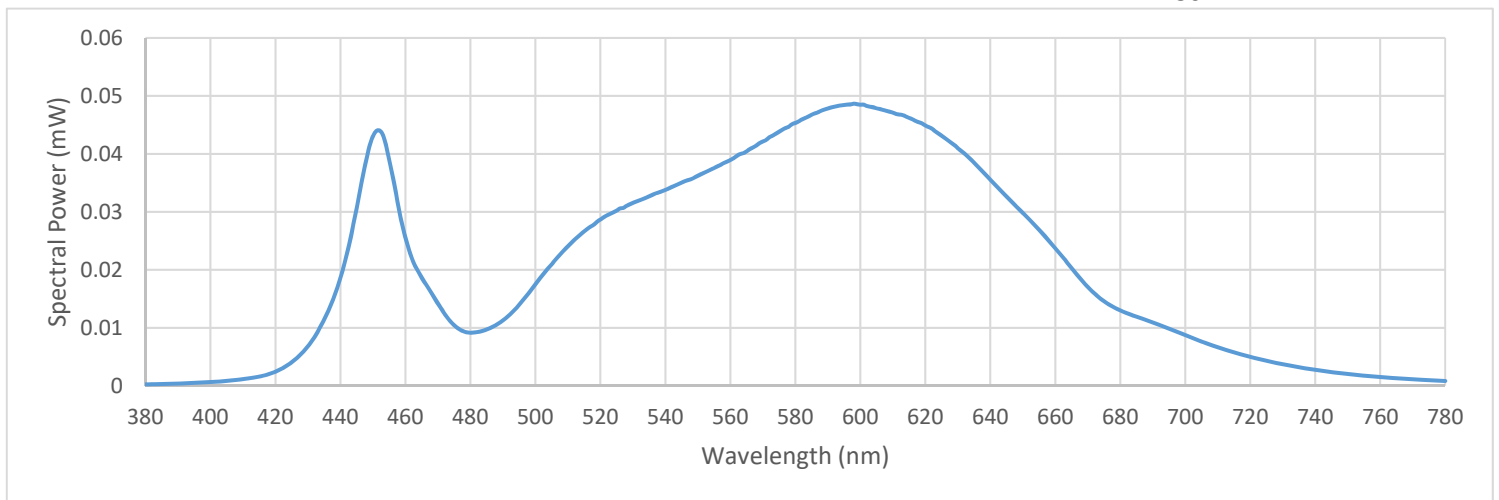

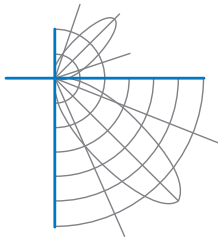

IES TM-30 Summary

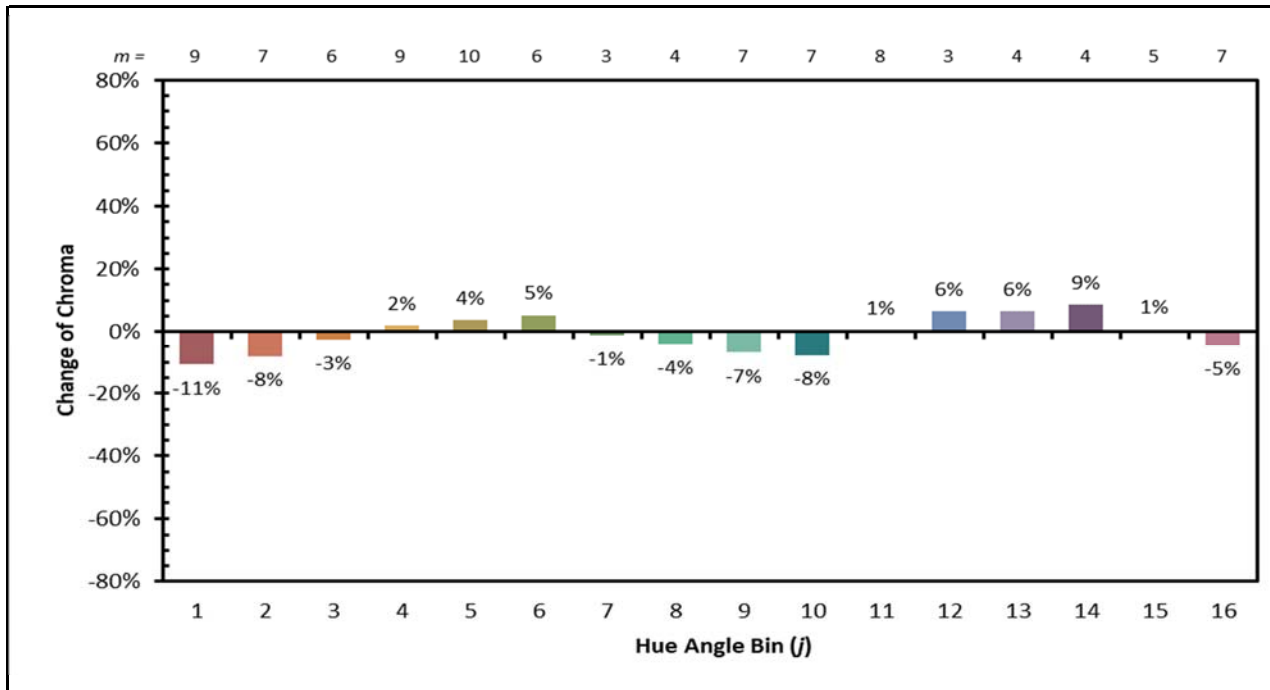
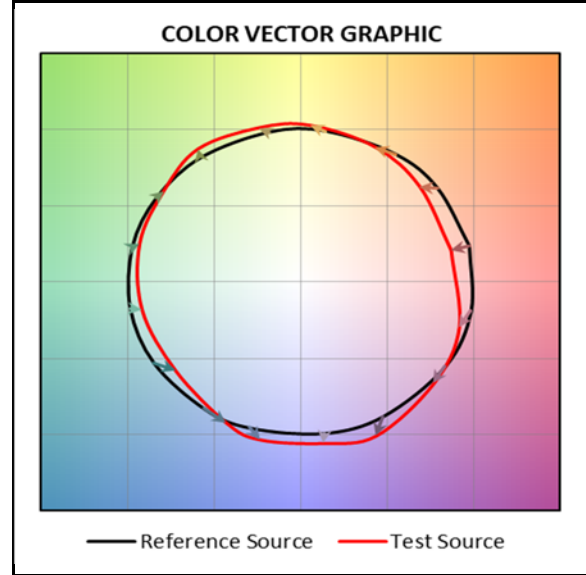
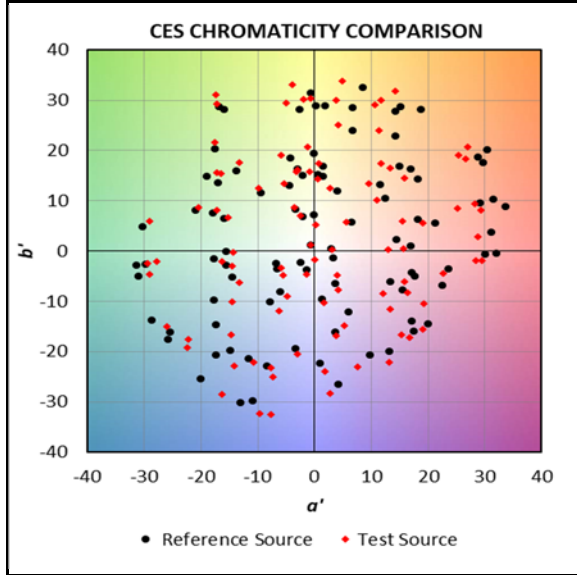



Test Report Number: LLIA000998-001B-R01

Catalog Number: ML3WL-D-HO-ASY-K35-4-X-VR-X

Pendant mounted, extruded aluminum housing, formed white enamel aluminum reflector tray, frosted plastic enclosure.

120 White LEDs, two Osram PrevaLED Line boards with 60 LEDs each, prismatic plastic optics below
. One Osram Optotronic OTi 50/120-277/1A 4 DIM L LED driver labeled as 600mA.

Test Equipment Configuration: LightLab International Allentown 2m Integrating Sphere
Measurements acquired using a Labsphere CDS 2600 spectroradiometer
Testing was performed using 4 π geometry

Test Temperature: 24.3 °C

Test Procedure: Tested in accordance with the applicable sections of:
LM-79-08, LM-78-07, LM-58-13, ANSI_ANSLG C78.377-2015,
ANSI C82-77-10:2014, TM-30-15

Significance: The laboratory has not participated in the selection of samples to be tested.
All testing is performed on the understanding that the significance of the report is limited to the extent that the test sample is representative of production units.

Notes: The measurements and other derived quantities contained in this report are based on the absolute data as measured.

Prorating the performance of the sample for the use of other component combinations (such as lamp / LED / Ballast / driver), or for use in different environmental conditions than that tested, may produce erroneous results.

This report is free of erasures and corrections

This report may contain data that are not covered by the NVLAP accreditation. Quantities marked with * are not covered.

Revision: No change made to this report-revision was issued to keep in numerical order with gonio revision to add LCS page.