



Report of Test

LLIA001418-005A

Indoor Distribution Photometry Test Report

Catalog Number: QP2-IASY/D-HO/HO-K40-80-4-XX-OP/PBF01M-FXXX-UNV-DIM1
Wall mounted, extruded aluminum housing, white enamel aluminum reflectors, clear plastic enclosure above LEDs, formed white enamel aluminum baffle with frosted plastic insert. 92 upper white LEDs, 128 white lower LEDs. One Osram Optotronic OTi 30/120-277/1A0 L G2 LED driver labeled as 720mA and one OTi50/120-277/1A4 DIM-1 L G2 driver labeled as 1240mA.

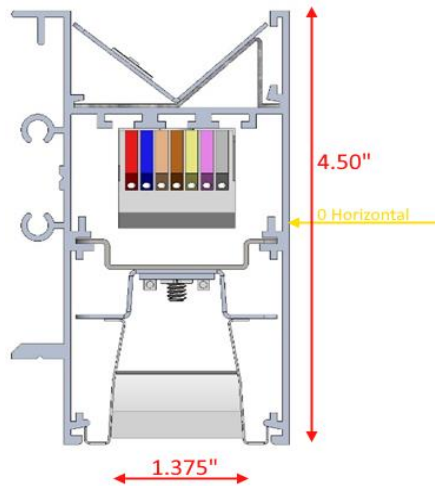

Prepared For:
Precision Architectural Lighting
4830 Timber Creek Drive
Houston, TX 77017, USA

Performance Summary			
Input Voltage	120.0 V	Luminous Flux	6713.8 Lumens
Input Current	0.5102 A	Total Efficacy	112.5 Lm/W
Input Power	59.69 W	Downward Flux	2709.3 Lumens
Frequency	60.00 Hz	Downward Flux	40.4 % of Total
Power Factor	0.975		
Current THD	8.2 %		

This test report was issued by LightLab International Allentown, LLC without alterations or erasures.

Test date: 03/05/2021
Report date: 03/08/2021

Signed: _____

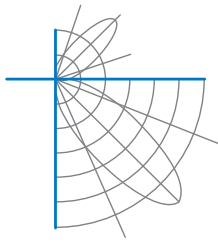

Report of Test
LLIA001418-005A

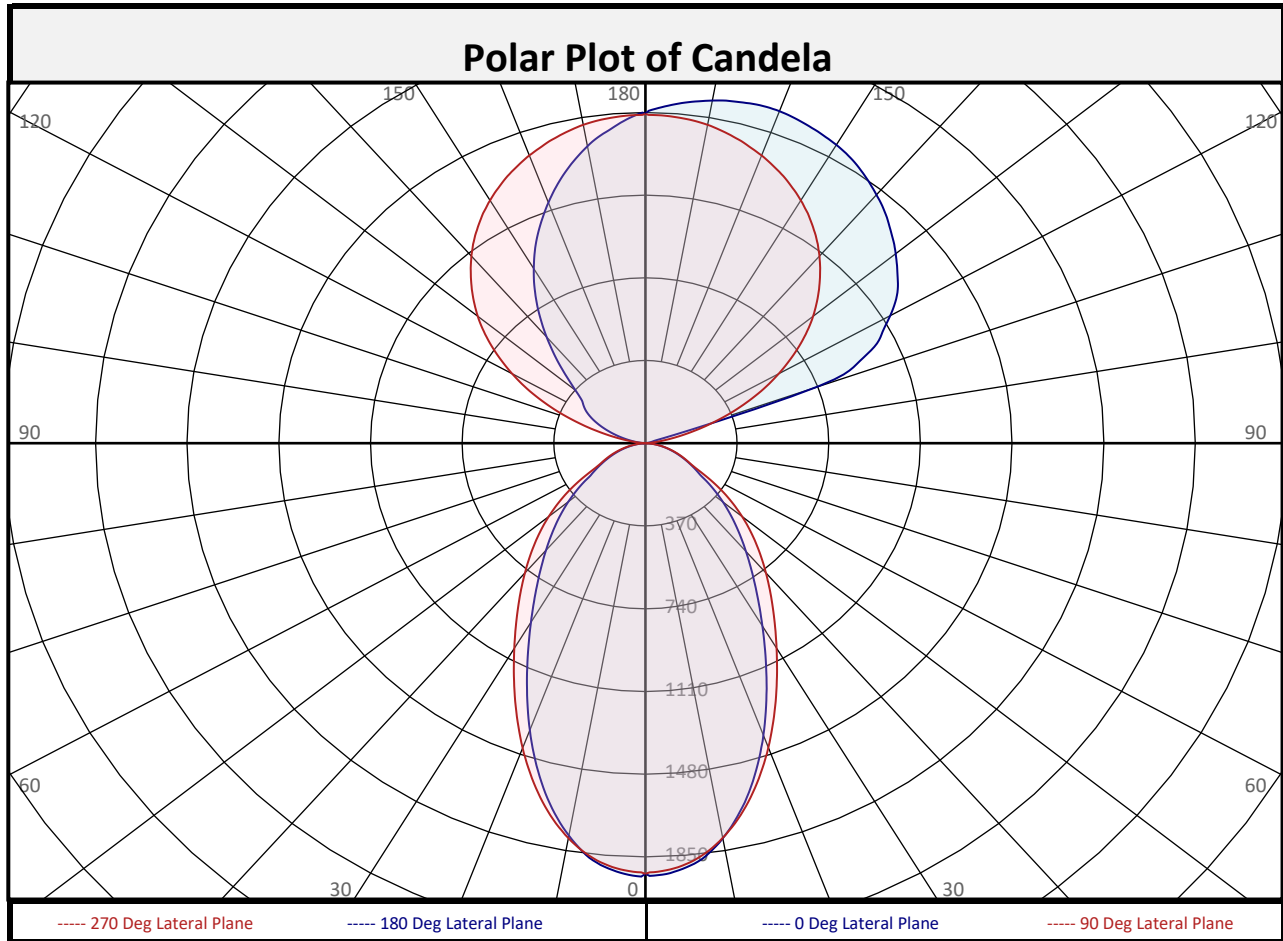

Zonal Flux Summary

Zone (Deg Vert)	Flux (Lumens)	Percent of Total	Zone (Deg Vert)	Flux (Lumens)	Percent of Total	Zone (Deg Vert)	Flux (Lumens)	Percent of Total
0-10	177.7	2.6%	90-100	20.3	0.3%	0-20	630.5	9.4%
10-20	452.8	6.7%	100-110	200.8	3.0%	0-30	1178	17.5%
20-30	547.7	8.2%	110-120	519.9	7.7%	0-40	1686	25.1%
30-40	508.1	7.6%	120-130	663.9	9.9%	0-60	2406	35.8%
40-50	419.5	6.2%	130-140	737.8	11.0%	0-80	2685	40.0%
50-60	299.7	4.5%	140-150	721.2	10.7%	10-90	2532	37.7%
60-70	181.2	2.7%	150-160	602.3	9.0%	20-50	1475	22.0%
70-80	98.2	1.5%	160-170	398.8	5.9%	40-90	1023	15.2%
80-90	24.4	0.4%	170-180	139.5	2.1%	60-90	303.8	4.5%
0-90	2709	40.3%	90-180	4005	59.7%	0-180	6714	100.0%

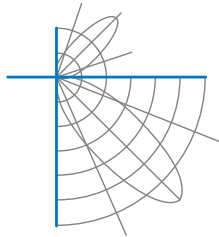

Report of Test

LLIA001418-005A

Luminous Intensity (Candela) Table

		Lateral (C-Plane) Angles								
		0	22.5	45	67.5	90	112.5	135	157.5	180
Vertical (Gamma) Angles	0	1927	1927	1927	1927	1927	1927	1927	1927	1927
	2.5	1929	1926	1918	1913	1913	1912	1916	1922	1929
	5	1904	1901	1895	1890	1890	1888	1890	1895	1902
	7.5	1863	1862	1856	1850	1850	1848	1849	1852	1856
	10	1795	1796	1802	1795	1794	1791	1791	1782	1783
	12.5	1712	1715	1724	1725	1723	1721	1710	1697	1697
	15	1616	1621	1634	1643	1641	1639	1618	1600	1596
	17.5	1507	1515	1533	1551	1548	1545	1516	1491	1485
	20	1392	1401	1426	1448	1450	1441	1408	1376	1367
	22.5	1273	1284	1315	1342	1349	1334	1297	1259	1249
	25	1156	1167	1204	1236	1248	1227	1185	1143	1134
	27.5	1046	1055	1094	1131	1151	1124	1076	1033	1025
	30	944	951	989	1032	1059	1024	973	931	927
	32.5	852	855	891	940	975	933	877	839	839
	35	770	769	802	855	897	848	790	757	760
	37.5	697	693	721	777	825	771	711	683	690
	40	630	624	648	706	757	700	640	617	626
	42.5	570	561	582	639	692	634	576	557	568
	45	513	505	522	578	631	573	518	502	512
	47.5	459	452	468	520	570	516	465	450	459
50	407	402	418	464	509	461	415	401	407	
52.5	357	355	371	410	448	407	369	354	356	
55	307	310	327	358	386	356	325	309	306	
57.5	260	267	286	308	323	306	284	265	259	
60	231	230	247	259	259	257	246	228	229	
62.5	204	203	211	214	213	213	210	201	202	
65	178	178	180	183	186	182	178	176	176	
67.5	155	155	155	159	163	158	154	153	152	
70	132	133	133	137	141	136	132	131	130	
72.5	111	111	112	116	119	115	111	109	109	
75	91	91	92	95	98	94	90	89	88	
77.5	71	72	73	76	78	74	71	70	69	
80	53	53	54	57	58	55	53	52	51	
82.5	36	36	37	38	39	37	36	35	35	
85	20	21	21	21	21	20	20	20	19	
87.5	6	7	8	7	6	7	7	6	5	
90	1	1	1	1	1	1	1	1	1	

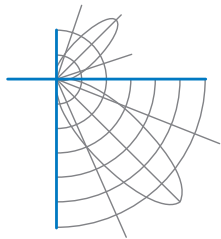

Report of Test

LLIA001418-005A

Luminous Intensity (Candela) Table

		Lateral (C-Plane) Angles								
		0	22.5	45	67.5	90	112.5	135	157.5	180
Vertical (Gamma) Angles	90	1	1	1	1	1	1	1	1	1
	92.5	4	3	4	3	4	4	5	6	6
	95	7	6	7	7	17	13	14	15	15
	97.5	11	11	11	68	43	28	28	29	30
	100	17	17	18	198	81	49	48	49	50
	102.5	25	25	64	269	130	73	72	73	74
	105	33	35	475	344	188	97	99	100	101
	107.5	123	373	583	418	255	129	128	129	129
	110	743	780	666	499	326	168	156	159	160
	112.5	923	881	742	584	401	217	183	189	190
	115	1019	962	816	662	476	273	206	218	219
	117.5	1079	1025	878	734	550	334	230	244	247
	120	1141	1092	942	806	621	399	263	267	271
	122.5	1200	1143	1005	874	690	466	307	285	292
	125	1244	1188	1064	940	758	536	361	307	308
	127.5	1281	1232	1124	1003	823	604	421	346	330
	130	1319	1274	1178	1059	884	671	486	394	371
	132.5	1354	1315	1224	1111	940	737	554	454	422
	135	1389	1355	1267	1158	993	800	623	520	485
	137.5	1422	1391	1307	1201	1044	862	691	588	553
140	1450	1424	1344	1240	1094	920	758	659	623	
142.5	1478	1454	1378	1277	1139	976	823	730	695	
145	1503	1480	1407	1311	1180	1029	888	799	767	
147.5	1524	1503	1435	1339	1220	1079	949	867	837	
150	1541	1522	1457	1367	1255	1128	1008	933	904	
152.5	1553	1538	1476	1391	1287	1172	1064	997	969	
155	1564	1552	1491	1411	1319	1214	1118	1057	1031	
157.5	1574	1560	1504	1430	1345	1252	1168	1114	1089	
160	1580	1564	1514	1445	1371	1289	1217	1169	1147	
162.5	1581	1566	1520	1458	1392	1322	1260	1221	1203	
165	1575	1563	1522	1468	1413	1354	1302	1269	1255	
167.5	1568	1556	1522	1477	1431	1381	1339	1313	1304	
170	1556	1546	1517	1483	1447	1407	1373	1354	1350	
172.5	1541	1533	1511	1483	1457	1428	1403	1391	1389	
175	1524	1518	1501	1481	1464	1444	1430	1425	1423	
177.5	1504	1501	1489	1476	1468	1458	1453	1454	1457	
180	1474	1474	1474	1474	1474	1474	1474	1474	1474	



Report of Test

LLIA001418-005A

Coefficients of Utilization/Room Utilization - Zonal Cavity Method																		
Effective Floor Cavity Reflectance 0.20																		
RC	80				70				50			30			10			0
RW	70	50	30	10	70	50	30	10	50	30	10	50	30	10	50	30	10	0
RCR																		
0	105	105	105	105	95	95	95	95	78	78	78	62	62	62	47	47	47	40
1	96	92	89	86	88	84	81	79	69	67	65	56	54	53	43	42	41	36
2	88	82	76	71	80	75	70	66	62	58	56	50	48	46	39	37	36	31
3	81	73	66	60	74	67	61	56	55	51	48	45	42	40	35	33	32	27
4	75	65	57	52	68	60	53	48	50	45	41	41	37	35	32	30	28	24
5	69	58	51	45	63	54	47	42	45	40	36	37	33	31	29	27	25	22
6	64	53	45	40	58	49	42	37	41	36	32	34	30	27	27	25	23	20
7	59	48	40	35	54	44	38	33	37	32	29	31	27	25	25	23	21	18
8	55	44	36	31	50	40	34	30	34	29	26	29	25	22	23	21	19	16
9	51	40	33	28	47	37	31	27	32	27	23	27	23	20	22	19	17	15
10	48	37	30	26	44	34	28	24	29	25	21	25	21	19	20	18	16	14

For absolute test reports, RUs are expressed as a percentage of total lumen output. For relative test reports, CUs are expressed as a percentage of total lamp output. Calculations were based on published IES procedures, and are based on the zonal cavity method. Basic assumptions: 1) Room surfaces are lambertian reflectors. 2) Incident flux on each surface is uniformly distributed. 3) The room is spectrally neutral. When luminaires are not evenly distributed throughout the room, or do not exhibit lateral symmetry, CU values may differ from actual performance.

Circle of Light Plot				
Height(ft)	Illuminance at Nadir (fc)	Ground-level distance to half-of-nadir illuminance (ft)		
		0-180 deg	90-270 deg	
6.0	53.5	5.10	5.43	
8.0	30.1	6.80	7.24	
10.0	19.3	8.50	9.05	
12.0	13.4	10.20	10.86	
14.0	9.8	11.90	12.68	
16.0	7.5	13.60	14.49	

Average Luminance (cd/m ²)			
	0 deg Plane	45 deg Plane	90 deg Plane
0	46588	46588	46588
45	17536	17850	21560
55	12948	13778	16291
65	10206	10295	10654
75	8463	8611	9155
85	5674	5738	5950

Spacing Criterion	
0 degree plane:	0.9
90 degree plane:	0.9
180 degree plane:	0.8
270 degree plane:	0.9

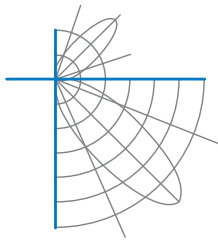

Report of Test

LLIA001418-005A

UGR TABLE - CORRECTED

Room Size		UGR Viewed Crosswise					UGR Viewed Endwise				
X=2H Y=2H		14.2	14.9	15.2	16.0	17.4	15.2	16.0	16.3	17.0	18.4
	3H	15.6	16.3	16.7	17.3	18.7	16.4	17.1	17.5	18.1	19.5
	4H	16.1	16.7	17.2	17.8	19.2	16.9	17.5	17.9	18.5	20.0
	6H	16.5	17.0	17.6	18.1	19.6	17.2	17.8	18.3	18.8	20.3
	8H	16.6	17.1	17.7	18.2	19.6	17.3	17.8	18.4	18.9	20.3
	12H	16.6	17.1	17.7	18.2	19.7	17.3	17.8	18.4	18.9	20.4
4H	2H	14.6	15.2	15.7	16.3	17.7	15.5	16.1	16.6	17.2	18.6
	3H	16.3	16.8	17.3	17.8	19.3	16.9	17.4	18.0	18.5	19.9
	4H	16.9	17.4	18.0	18.4	19.9	17.5	17.9	18.6	19.0	20.5
	6H	17.4	17.8	18.5	18.9	20.3	17.9	18.3	19.0	19.4	20.9
	8H	17.5	17.9	18.6	19.0	20.4	18.1	18.4	19.2	19.5	21.0
	12H	17.6	17.9	18.7	19.0	20.5	18.1	18.5	19.2	19.6	21.0
8H	4H	17.1	17.5	18.2	18.6	20.0	17.6	18.0	18.7	19.1	20.6
	6H	17.7	18.0	18.8	19.1	20.6	18.2	18.5	19.3	19.6	21.1
	8H	17.9	18.2	19.0	19.3	20.8	18.4	18.7	19.5	19.8	21.3
	12H	18.0	18.3	19.1	19.4	20.9	18.5	18.7	19.6	19.9	21.4
12H	4H	17.1	17.4	18.2	18.5	20.0	17.6	17.9	18.7	19.0	20.5
	6H	17.7	18.0	18.8	19.1	20.6	18.2	18.5	19.3	19.6	21.1
	8H	17.9	18.2	19.1	19.3	20.8	18.4	18.7	19.6	19.8	21.3

Maximum UGR = 21.4

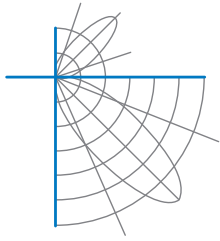

Report of Test
LLIA001418-005A

Iso-Illuminance Plot

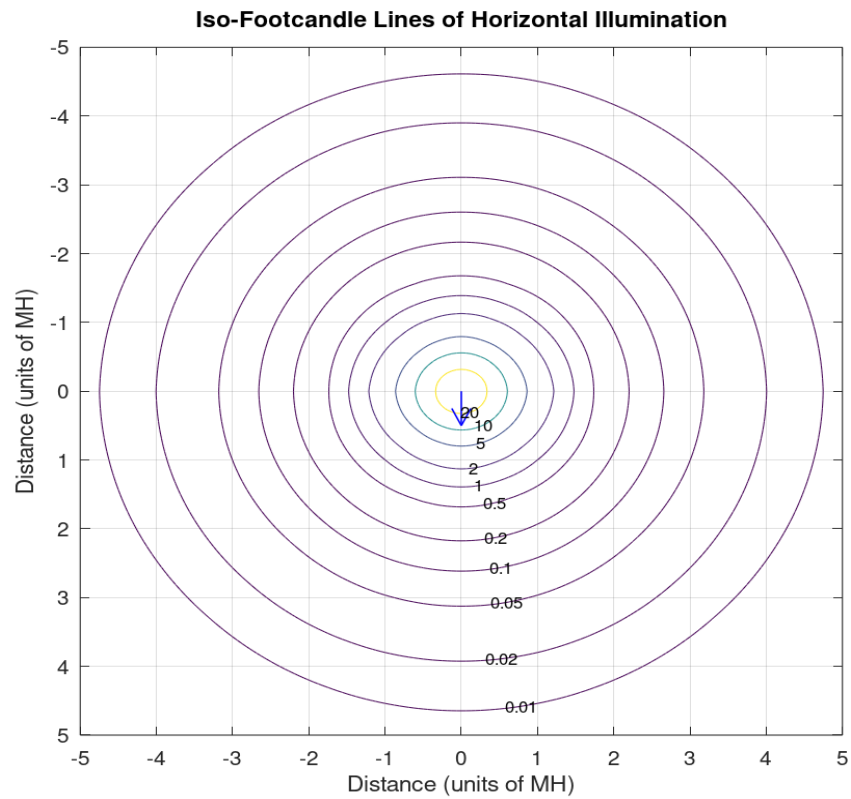

The isofootcandle values shown in the plot above are based on a mounting height of $h = 8.0$ feet. Grid values show multiples of mounting height. The isoilluminance contour lines are expressed in units of footcandles. The values expressed are based on the direct light from a single unit without the contribution of room reflections.

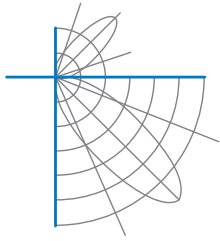

Report of Test
LLIA001418-005A

Additional Pictures of Test Subject

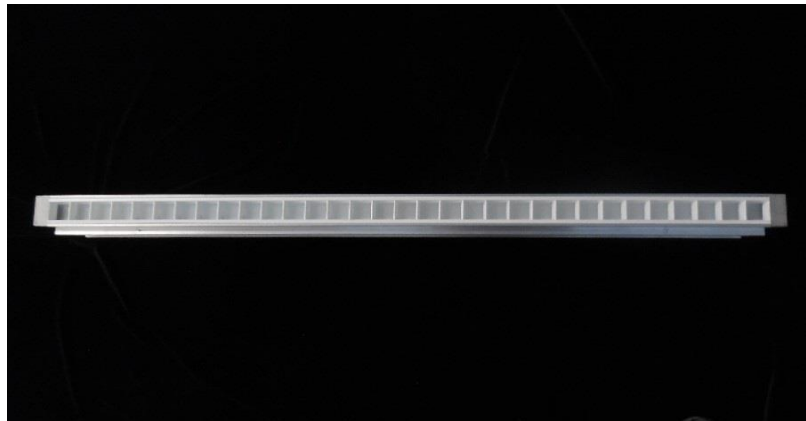

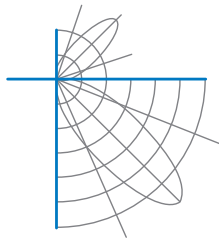

Report of Test

LLIA001418-005A

Test Distance 9.5 m
Ambient Temperature 25.0 °C

Notes

The laboratory has not participated in the selection of samples to be tested. All testing is performed on the understanding that the significance of the report is limited to the extent that the test sample is representative of production units.

Tested in accordance with the applicable sections of IES LM-79-19. Format of reports and angular increments based on IES LM-41-14 and LM-46-04.

The luminous intensity values, and other derived quantities, contained in this report are based on the absolute data, as measured.

Prorating the performance of the sample for the use of other component combinations (such as lamp / LED / Ballast / driver), or for use in different environmental conditions than that tested, may produce erroneous results.

This report is free of erasures and corrections.

Photometric intensity values are reported using the CIE C-Gamma coordinate system as defined in CIE publication number 121.

This report may contain data that are not covered by the NVLAP accreditation. Quantities marked with ‡ are not covered.

This report must not be used by the customer to claim product certification, approval or endorsement by NVLAP, NIST, or any agency of the Federal Government.

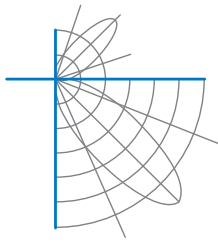

Report of Test

LLIA001418-005B

Integrating Sphere Report

Catalog Number: QP2-IASY/D-HO/HO-K40-80-4-XX-OP/PBF01M-FXXX-UNV-DIM1

Wall mounted, extruded aluminum housing, white enamel aluminum reflectors, clear plastic enclosure above LEDs, formed white enamel aluminum baffle with frosted plastic insert. 92 upper white LEDs, 128 white lower LEDs. One Osram Optotronic OTi 30/120-277/1A0 L G2 LED driver labeled as 720mA and one OTi50/120-277/1A4 DIM-1 L G2 driver labeled as 1240mA.

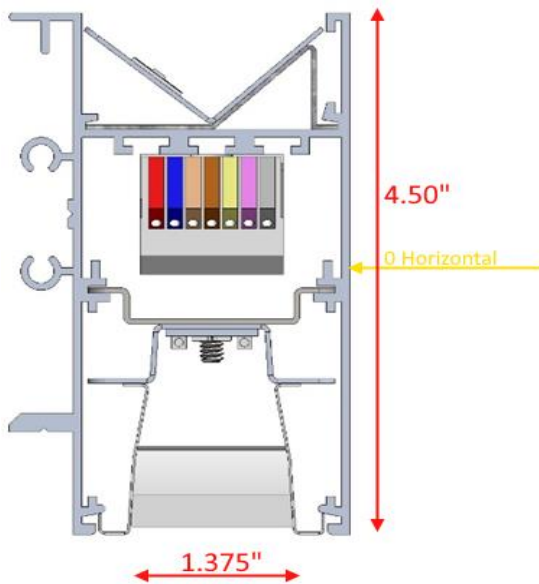

Performance Summary

Voltage	120.0 Vac
Current	0.5063 A
Power	59.69 W
Frequency	59.99 Hz
Power Factor	0.982
Current THD	9.4 %
Total Luminous Flux	6739.6 lm
Efficacy	112.9 lm/W
Chromaticity (x,y)	(0.3805, 0.3796)
(u',v')	(0.2240, 0.5028)
Duv	0.0013
CCT	4020 K
CRI (Ra)	83
R9	7
TM-30: Rf	81
TM-30: Rg	93
TM-30: Rcs,h1	-12

Prepared For:

Precision Architectural Lighting
4830 Timber Creek Drive
Houston, TX 77017, USA

Test date: 03/02/2021

Report date: 03/08/2021

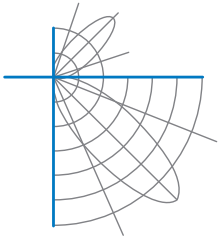

Test Report Number: LLIA001418-005B

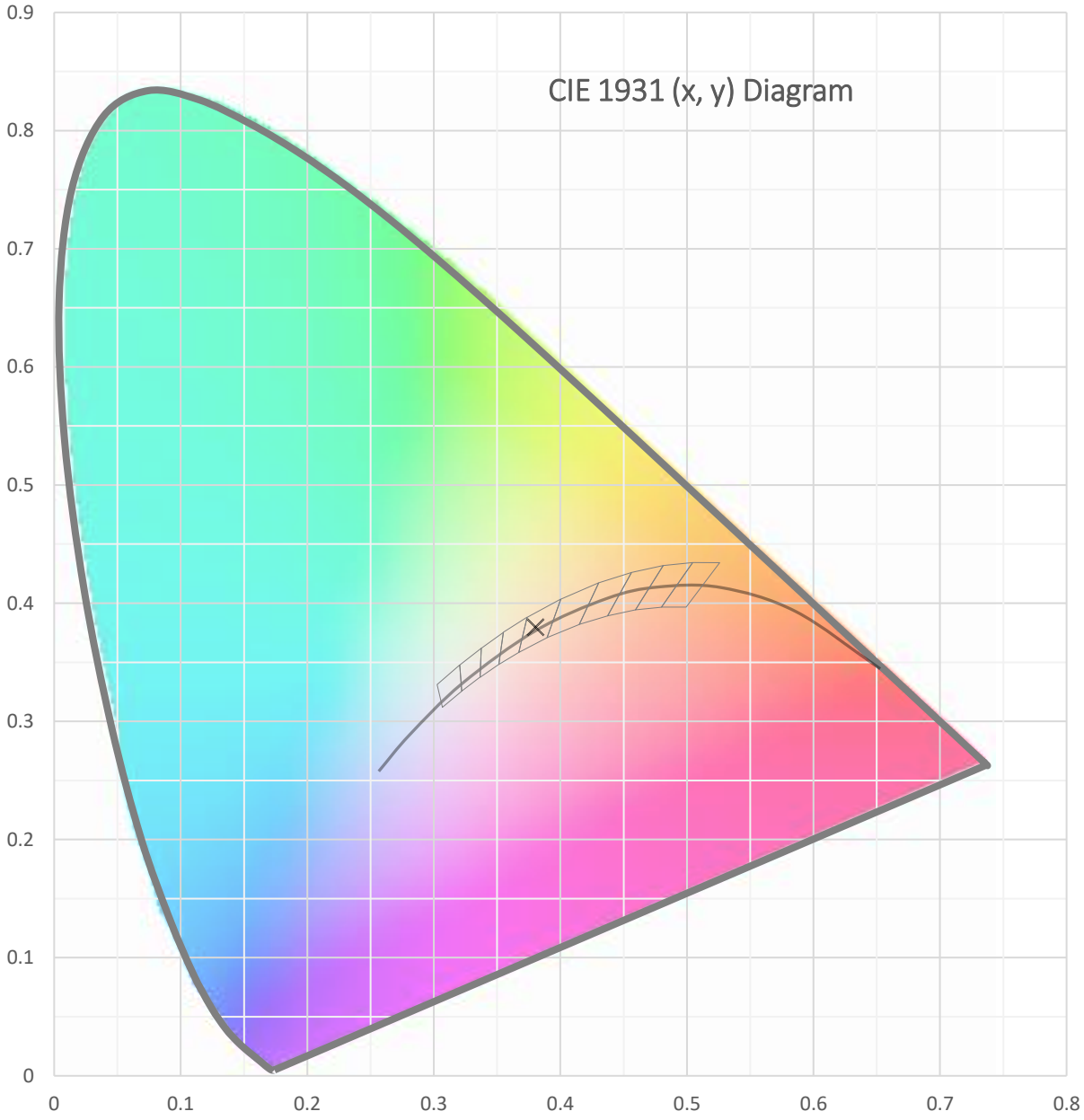

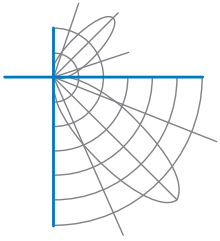

Test Report Number: LLIA001418-005B

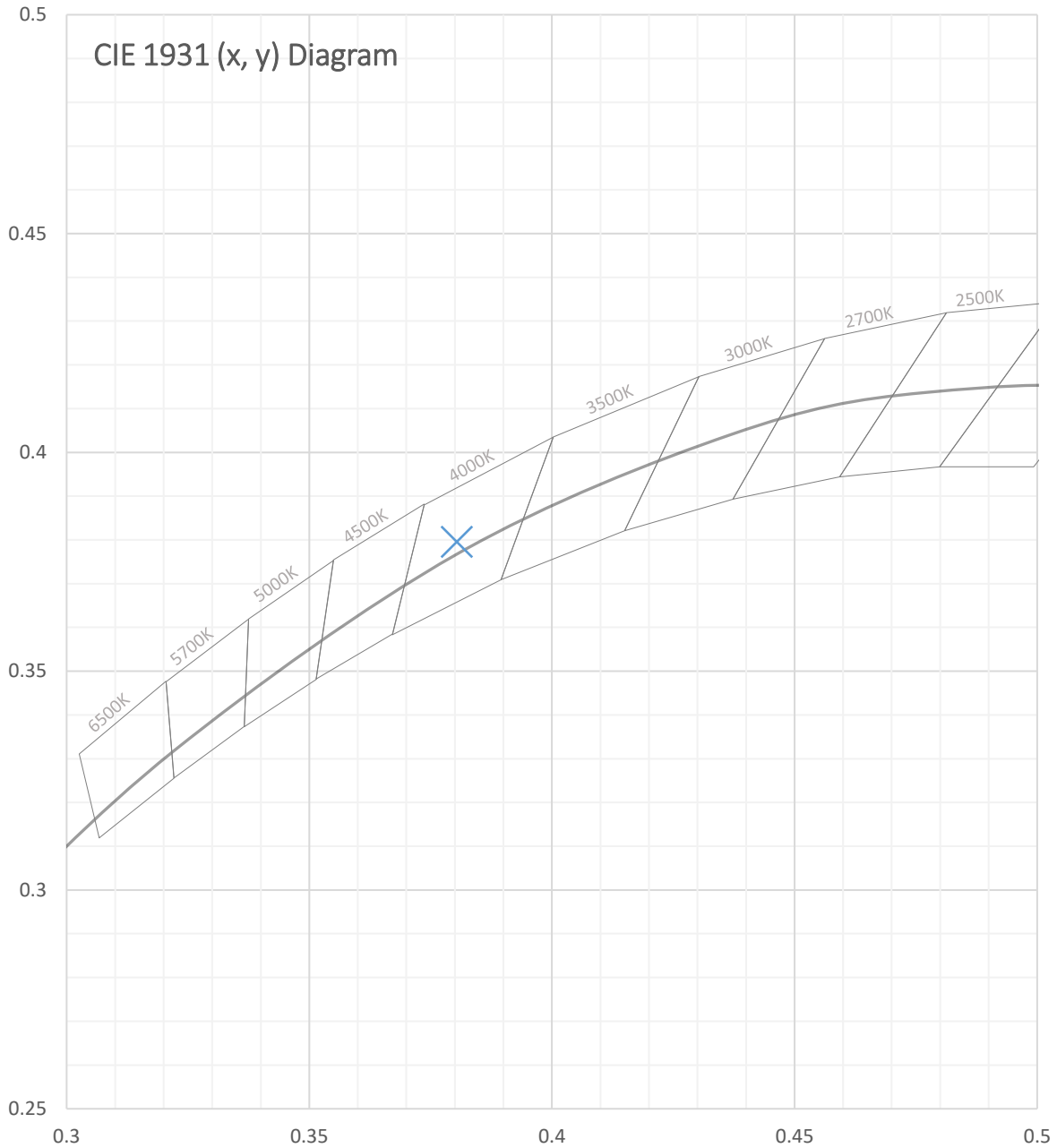



Test Report Number: LLIA001418-005B

Total Radiant Flux	20.47 W
Total Luminous Flux	6739.6 Lm
Chromaticity CIE 1931 (x, y)	(0.3805, 0.3796)
Chromaticity CIE 1976 (u', v')	(0.2240, 0.5028)
Correlated Color Temperature (CCT)	4020 K
Color Rendering Index (Ra)	83
R1	81
R2	91
R3	96
R4	80
R5	81
R6	86
R7	85
R8	63
R9	7
R10	77
R11	79
R12	60
R13	84
R14	98
TM-30: Rf	81
TM-30: Rg	93
TM-30: Rcs,h1	-12
Distance from Planckian Locus (Duv)	0.0013
Scotopic/Photopic Ratio ‡	1.713

Electrical Data

Voltage	120.0 Vac
Current	0.5063 A
Power	59.69 W
Frequency	59.99 Hz
Power Factor	0.982
Current THD	9.4 %



Test Report Number: LLIA001418-005B

Summary Spectral Power Distribution (wavelength - nm, spectral power - W/nm)

380	0.000712	480	0.038818	580	0.113341	680	0.026331
385	0.000759	485	0.038162	585	0.115664	685	0.022822
390	0.000938	490	0.041337	590	0.117064	690	0.019632
395	0.001167	495	0.046571	595	0.117212	695	0.016844
400	0.001554	500	0.053781	600	0.116499	700	0.014486
405	0.002034	505	0.061280	605	0.114060	705	0.012356
410	0.002672	510	0.067745	610	0.110418	710	0.010542
415	0.003547	515	0.072979	615	0.105895	715	0.009062
420	0.005175	520	0.077242	620	0.100065	720	0.007752
425	0.008130	525	0.080306	625	0.093766	725	0.006617
430	0.013328	530	0.082803	630	0.086777	730	0.005660
435	0.022431	535	0.085342	635	0.079779	735	0.004822
440	0.037174	540	0.087576	640	0.072444	740	0.004114
445	0.063052	545	0.090273	645	0.065338	745	0.003508
450	0.105341	550	0.093054	650	0.058514	750	0.003014
455	0.133384	555	0.096188	655	0.052000	755	0.002582
460	0.106487	560	0.099553	660	0.045992	760	0.002232
465	0.074916	565	0.103098	665	0.040150	765	0.001914
470	0.061794	570	0.106756	670	0.034944	770	0.001646
475	0.047867	575	0.110430	675	0.030387	775	0.001407
						780	0.001221

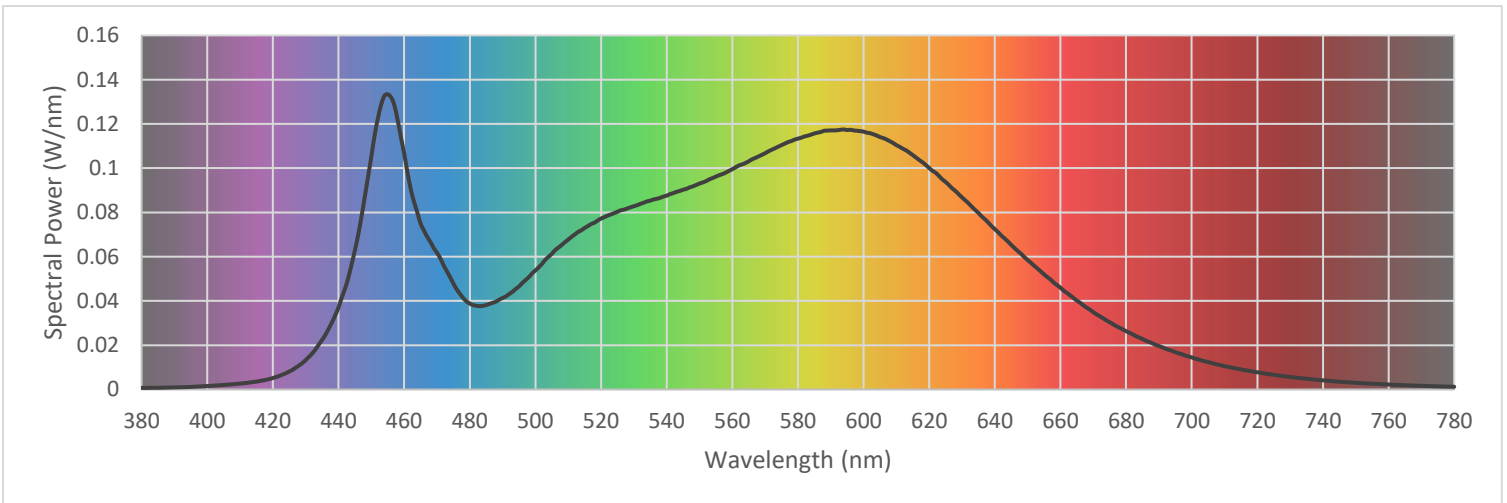

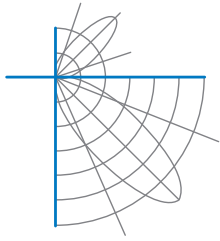

Test Report Number: LLIA001418-005B

IES TM-30 Details

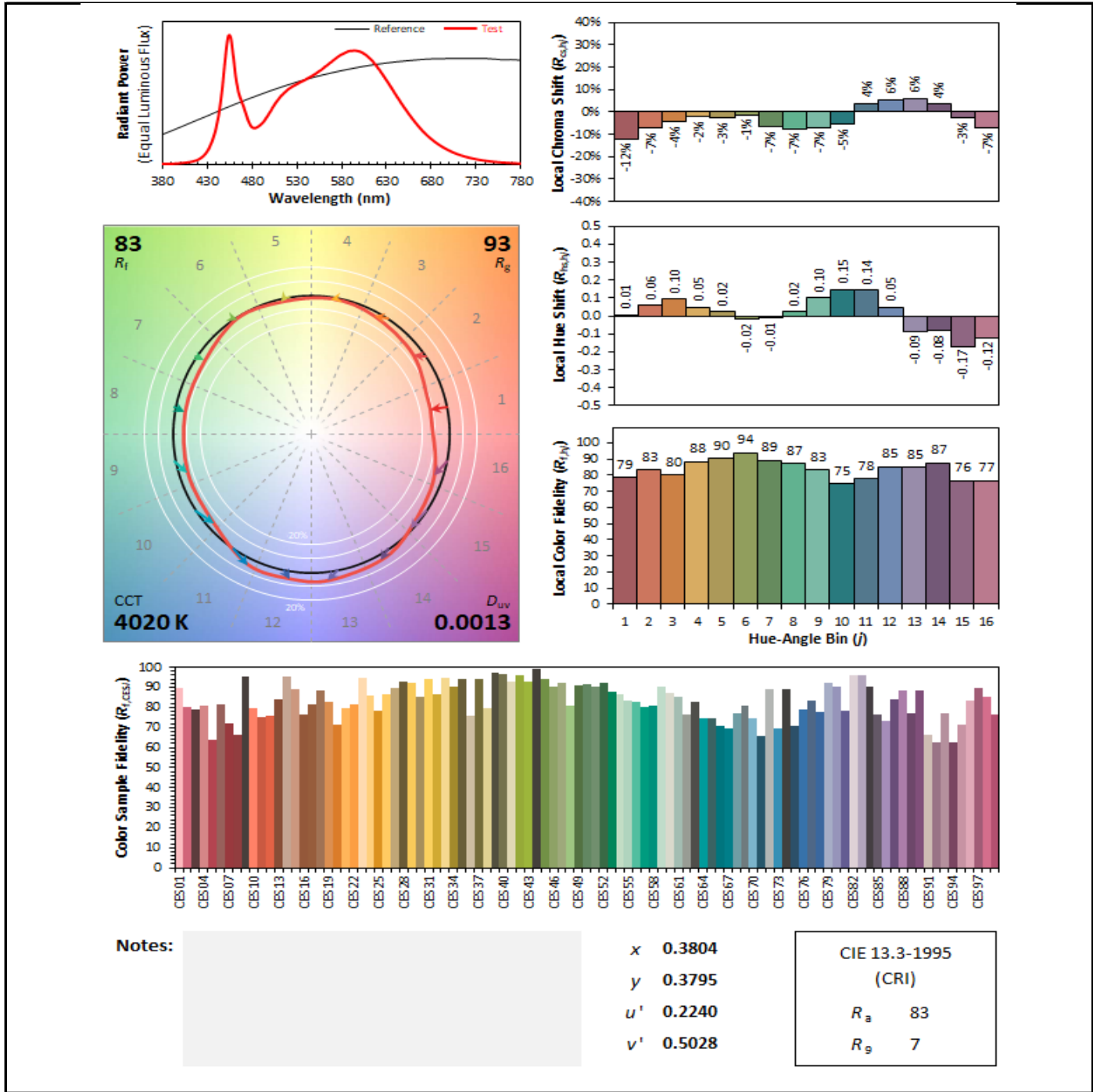

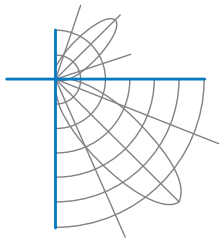

Test Report Number: LLIA001418-005B

Test Equipment Configuration: LightLab International Allentown 2m Integrating Sphere
Measurements acquired using a Labsphere CDS 2600 spectroradiometer
Testing was performed using 4π geometry

Test Temperature: 25.7 °C

Test Procedure: Tested in accordance with the applicable sections of:
LM-79-19, LM-78-07, LM-58-13, ANSI_ANSLG C78.377-2017, TM-30-18

Significance: The laboratory has not participated in the selection of samples to be tested.
All testing is performed on the understanding that the significance of the report is limited to the extent that the test sample is representative of production units.

Notes: The measurements and other derived quantities contained in this report are based on the absolute data as measured.

Prorating the performance of the sample for the use of other component combinations (such as lamp / LED / Ballast / driver), or for use in different environmental conditions than that tested, may produce erroneous results.

This report is free of erasures and corrections

This report may contain data that are not covered by the NVLAP accreditation. Quantities marked with ‡ are not covered.

This report must not be used by the customer to claim product certification, approval or endorsement by NVLAP, NIST, or any agency of the Federal Government.