

# Microlinea™ Recessed Series 5 - with Regress Lens

(4 7/8" Luminous Aperture)

Catalog Number	Type
Project Name	



Vertical Drywall  
Overlap Flange



Vertical Drywall  
Spackle Flange

## S P E C I F I C A T I O N S

### Housing

Three piece extruded aluminum available in single sections up to 8' long in 1' increments. Standard flange finish is satin white.

### Optical Control

(LOH) High transmittance extruded acrylic snap-in lens, formulated for maximum diffusion of the LED light source. Lens is regressed 1" inside the wall.

### Reflector/Heat Sink

.040" thick die-formed aluminum finished with a high reflectance white enamel.

### Circuitry

All fixtures are factory pre-wired for a single circuit. Provision for multiple switching/circuiting is optional.

### Wiring

All fixtures intended for continuous rows are provided with factory installed quick-connect wiring.

### Integral Controls

Contact factory for daylight and/or occupancy sensor controls.

### Certification

Fixtures are ETL listed for use in 'Dry or Damp Applications'. Conforms to UL Standard #1598 and to CAN/CSA #C22.2No.250.0.

### Driver (Standard)

Power supply is UL/CUL recognized, 0-10V dimming available 120-277 universal voltage. 347V is available.

### Light Engine (Standard)

LED light source available standard for 3000K, 3500K and 4000K CCT, in high and medium light outputs, and 80 or 90 CRI. Standard outputs:

#### HO - High Output (DLC Listed)

\*3477 Total Delivered Lms. at 29 System Watts

#### MO - Medium Output (DLC Listed)

\*2074 Total Delivered Lms. at 17 System Watts

(\*All values per 4' using 3500K LED modules)

### Driver (Tunable White)

EldoLED power supply is UL recognized, DALI, 0-10V or DMX available, 120-277 universal voltage.

### Light Engine (Tunable White)

Tunable White LED light source available for 2700K thru 6500K CCT, and 80 or 90 CRI. Contact factory for available outputs.

\*Due to continued advancement in LED technology, lumen performance is subject to change. Please visit our website for the most up-to-date information.

**Note: This fixture requires a minimum wall depth of 6" for installation.**

## Vertical Wall Mt. - 1/2" or 5/8" Thick Drywall



Limited Warranty  
LED Boards & Drivers

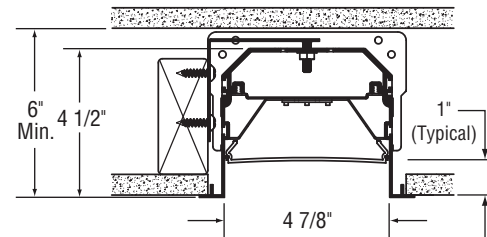

MLR5RG-HO-VOF  
MLR5RG-MO-VOF  
Vertical Drywall  
Overlap Flange

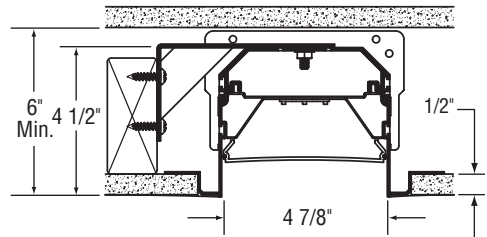

MLR5RG-HO-VSF1  
MLR5RG-MO-VSF1  
Vertical Drywall  
Spackle Flange

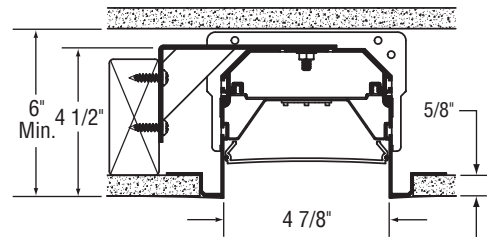

MLR5RG-HO-VSF5  
MLR5RG-MO-VSF5  
Vertical Drywall  
Spackle Flange

Sample Catalog Number: **MLR5RG - HO - K40 - 80 - 4 - VOF - LOH - 120 - DIM1 - OPTIONS**

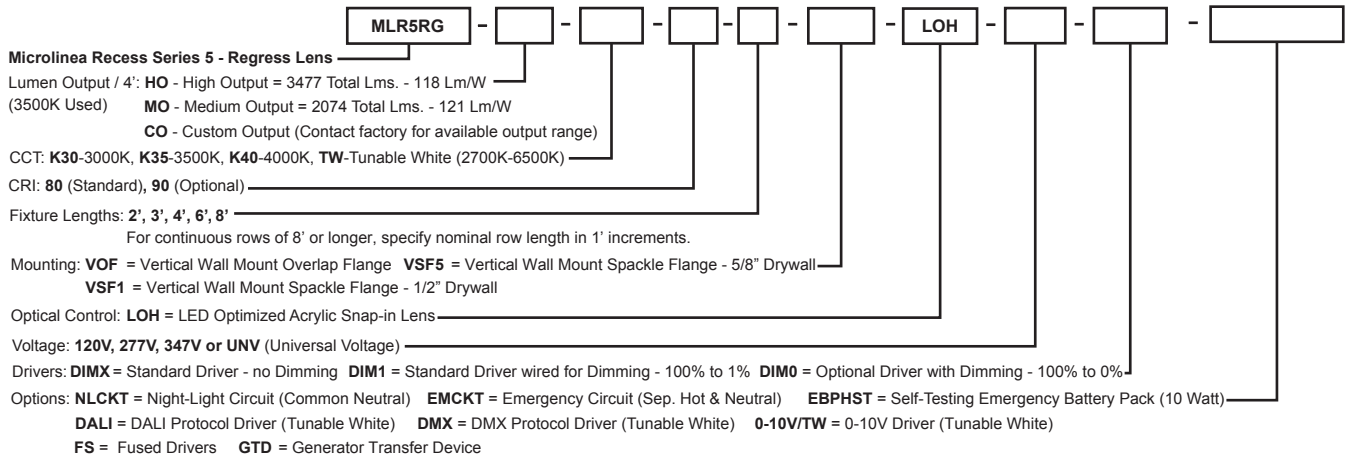

Precision Architectural Lighting 4830 Timber Creek Drive Houston, Texas 77017  
Tel 713.946.4343 Fax 713.946.4441 www.pal-lighting.com



# Recessed - Regress Lens

## MLR5RG-HO-K35-LOH

### High Output

#### LED Optimized High Transmittance Lens

**Catalog Number:** MLR5RG-HO-K35-80-4'-X-LOH-120

**Report Number:** #LLIA001168-006.ies

**Luminaire Description:** Extruded Aluminum Housing with White Aluminum Reflector and LED Optimized Acrylic Lens.

**LED Module:** Multiple White Low-Power Light Emitting Diodes (LEDs) in a uniform grid pattern.

Total Luminaire Efficacy = 118.1 Lm/W

0% Up 100% Down

Color Rendering Index (CRI) = 82

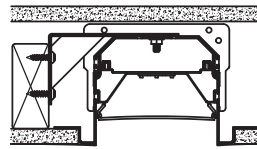
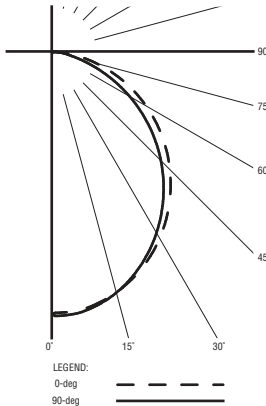

#### ZONAL LUMEN SUMMARY

Zone	Lumens	%Fixture
0- 40	1658	47.7
0- 60	2839	81.7
0- 90	3477	100.0
90- 180	0	0.0
0- 180	3477	100.0

#### CANDELA DISTRIBUTION

	0.0	22.5	45.0	67.5	90.0
0	1357	1357	1357	1357	1357
5	1345	1347	1350	1355	1361
15	1285	1288	1285	1288	1288
25	1177	1175	1164	1161	1159
35	1030	1022	1004	993	990
45	855	841	817	800	793
55	658	641	611	586	575
65	447	430	394	360	347
75	234	220	179	151	144
85	57	43	40	39	39
90	1	1	2	2	3

## MLR5RG-MO-K35-LOH

### Medium Output

#### LED Optimized High Transmittance Lens

**Catalog Number:** MLR5RG-MO-K35-80-4'-X-LOH-120

**Report Number:** #LLIA001168-005.ies

**Luminaire Description:** Extruded Aluminum Housing with White Aluminum Reflector and LED Optimized Acrylic Lens.

**LED Module:** Multiple White Low-Power Light Emitting Diodes (LEDs) in a uniform grid pattern.

Total Luminaire Efficacy = 120.8 Lm/W

0% Up 100% Down

Color Rendering Index (CRI) = 82

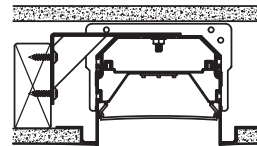
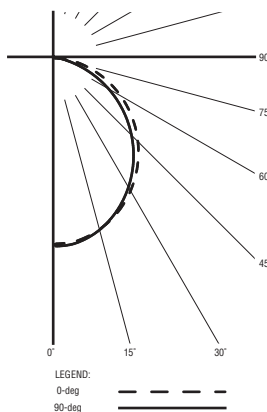

#### ZONAL LUMEN SUMMARY

Zone	Lumens	%Fixture
0- 40	989	47.7
0- 60	1693	81.7
0- 90	2074	100.0
90- 180	0	0.0
0- 180	2074	100.0

#### CANDELA DISTRIBUTION

	0.0	22.5	45.0	67.5	90.0
0	809	809	809	809	809
5	803	803	805	808	812
15	767	768	767	768	768
25	702	701	694	692	691
35	614	610	599	593	591
45	510	502	487	477	473
55	392	383	365	349	343
65	267	257	235	215	207
75	140	131	107	90	86
85	34	26	24	23	23
90	0	0	1	1	1

For more information, visit our website at [www.pal-lighting.com](http://www.pal-lighting.com)



Precision Architectural Lighting 4830 Timber Creek Drive Houston, Texas 77017  
Tel 713.946.4343 Fax 713.946.4441 [www.pal-lighting.com](http://www.pal-lighting.com)



Made in America