

Job Name:

Contact:

Ordering Code:

Fixture Type:

## AIRbar T-Bar Mount 0.5

### Description

The AIRbar T-Bar Mount 0.5 luminaire with Suspended Ceiling Ribbon Cable Connector allows for easy integration into drop ceiling T-Bar grid applications, and allows for ultimate flexibility for all lighting projects. Its ultra slim profile at 5mm thick and lightweight housing directly attaches to the T-Bar grid with integrated magnets. Capable of 495 lumens/foot @ 121 lumens per watt efficacy, the AIRbar can be installed individually or linked continuously. A truly sustainable light source comprised of ceramic and aluminum, the AIRbar uses 50x fewer raw materials than conventional light sources (measured by weight of fixtures in a typical installation).

### Housing

- 1/2" (nominal) wide housing delivers 495 lumens per foot
- 24" L x 0.6" W x 0.24" H
- 0.7oz per foot (66g/m)
- The ceramic light emitting surface acts as the heatsink and circuit board for the chip scale package LEDs
- The light weight aluminum housing reflects the LED light back out through the ceramic

### Mounting

- 9/16 T-bar applications
- Magnetically attaches directly to steel T-Bar Grid using powerful magnets
- Ribbon Cable Connector easily fits between ceiling tiles and T-Bar
- Seismic U-Clip included (mechanically secures Ribbon Cable to T-Bar)

### Electrical

- 4.1W per foot, 24.7Vdc Constant Voltage input
- Remote Class 2 Power Supply required (refer to Power Supply section)
- Maximum 22 foot run with one 100W power supply
- Unlimited run lengths using multiple power supplies
- Dimmable to less than 1% (refer to Control Accessories section)
- Interconnection/Cabling (supplied by others): Plenum Rated 2-18 AWG Stranded with Flame Resistant Insulation. Example: BELDEN # 6300UE
- Integrated thermal feedback protection prevents overheating under abnormal power conditions

### Listings

- cULus Listed to UL2108
- Rated both Type IC & non-IC
- Suitable for dry and damp locations
- Operating environment: -10°F to 115°F / -23°C to 46°C
- Certified to be the first, and only, lighting product to obtain an **LBC Red List Free** Declare label with the International Living Future Institute's (ILFI) Living Building Challenge.

Delivered Lumens Per Foot	CCT
495	4000K
486	3500K
486	3000K
444	2700K



## Ordering Codes

Follow the steps to specify your fixture, example: **120 - TB - 10 - 24 - 40K - 80**

Part Number	Mounting	Width	Length	CCT	CRI
120 AIRbar	TB T-Bar	05 1/2" wide (nominal)	24 24" Long	27K 2700K 30K 3000K 35K 3500K 40K 4000K	80 80CRI 90 <sup>1</sup> 90CRI

**Notes**  
 1. 90 CRI is ONLY available in 2700K and 3000K.

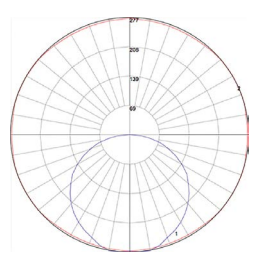
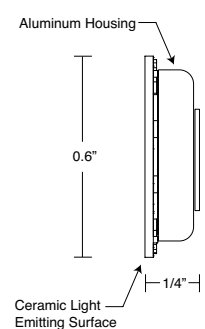

Perfectly Lambertian



Job Name:	Contact:
Ordering Code:	Fixture Type:

## LED Performance

<b>LED</b>	Samsung chip scale package (LM101A series)
<b>SDCM</b>	3 Step MacAdam Ellipse
<b>CCT</b>	2700K, 3000K, 3500K, 4000K
<b>CRI Ra</b>	82-84 typical (consult factory for 90CRI lead time)
<b>Efficacy</b>	121 lumens/Watt (4000K)
<b>Light Emitting Surface</b>	Reaches 45°C in a 25°C environment at 24.7Vdc input.
<b>Life</b>	L70 > 54,000hrs
<b>Warranty</b>	5 year limited fixture warranty

## Power Supplies

(factory-set to 24.1Vdc output)

<b>P70495-100-241</b>	96W/24.1V adjustable Power Supply (Meanwell HLG-100H-24A) with ETL Listed Enclosure / Operates 0 to 22 Linear Feet
<b>P70495-80-241</b>	80W/24.1V adjustable Power Supply (Meanwell HLG-80H-24A) with ETL Listed Enclosure / Operates 0 to 18 Linear Feet
<b>P70495-60-241</b>	60W/24.1V adjustable Power Supply (Meanwell HLG-60H-24A) with ETL Listed Enclosure / Operates 0 to 13 Linear Feet
<b>P70495-40-241</b>	40W/24.1V adjustable Power Supply (Meanwell HLG-40H-24A) with ETL Listed Enclosure / Operates 0 to 9 Linear Feet

## Control Accessories

ILLUMRA™ Constant Voltage LED Dimming Controllers deliver 65,000 PWM dimming steps to provide ultra smooth dimming performance through all light levels. Pair these controllers with either hardwired 0-10V dimming systems or Illumra's wireless Rocker Switches. These Controllers must be wired between the output of the Power Supply and the input of the LED Luminaire, so no auxiliary power source is required.

- p/n: 70496-001** ILLUMRA™ (hardwired) 0-10V Controller NWO-D02FP-C01  
Use this controller to support 0-10V dimming. Compatible with industry standard 0-10V dimmers (Leviton IP710-DLX or similar). Use one controller per Power Supply.
- p/n: 70496-002** ILLUMRA™ Wireless Controller E9X-D02FL  
Use this controller to support wireless dimming. Compatible with Illumra's Wireless Rocker Switches using EnOcean technology. Use one controller per Power Supply.



ILLUMRA™ self-powered Rocker Switches use no wires or batteries. Pressing the switch creates the energy to transmit a wireless signal that controls lights or other devices connected to EnOcean receivers. One Rocker Switch may be paired with one or more Controllers, or multiple Rocker Switches (up to 25) may be paired with one Controller. 50-150 foot range (typical) using 902MHz.

- p/n: 70497-001WH** ILLUMRA™ Wireless Single Rocker Switch (WHITE) E9T-S1AWH  
Use this Rocker Switch for ON/OFF/Dimming (100% to <1%) control. Compatible with Illumra's Wireless Controllers.



- p/n: 70497-002WH** ILLUMRA™ Wireless Dual Rocker Switch (WHITE) E9T-S2AWH  
Use this Rocker Switch for ON/OFF/Dimming (100% to <1%) control of two lights or two groups of lights. Compatible with Illumra's Wireless Controllers.

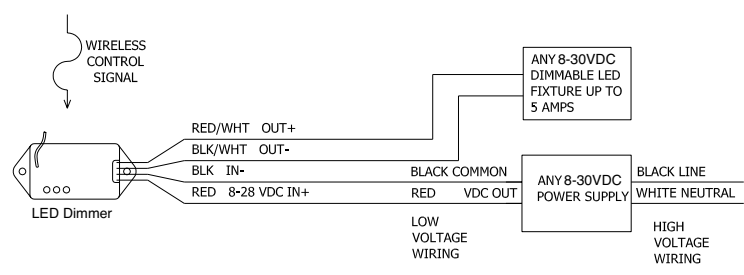

Job Name:

Contact:

Ordering Code:

Fixture Type:

## T-Bar/Suspended Ceiling Compatibility

AIRbar SC 0.5 is compatible with Main Beam and Cross Tee types:

- ✓ 9/16" galvanized steel (with a "flat" mounting surface)
  - Installed with Flush or tegular Tiles

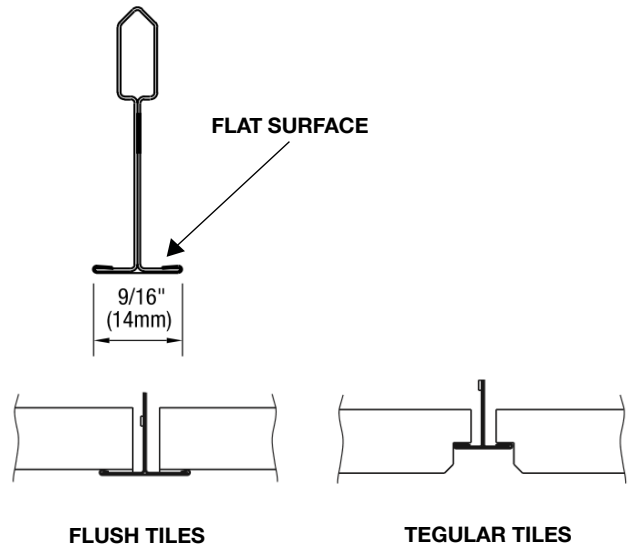

## T-Bar/Suspended Ceiling NON-Compatibility

AIRbar SC 0.5 NOT compatible with Main Beam and Cross Tee sections made of:

- ✗ Aluminum
- ✗ Stainless Steel

NOT compatible with Profile types:

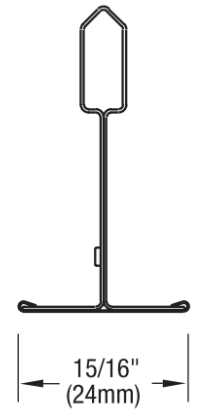
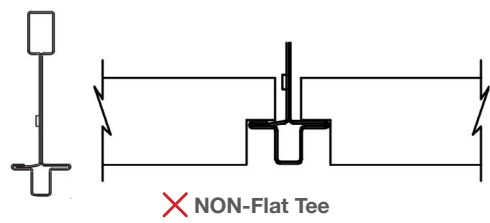
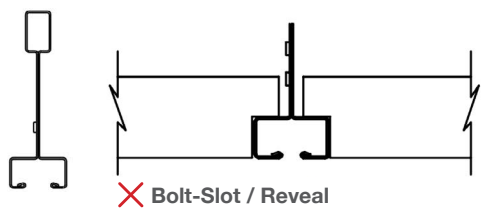
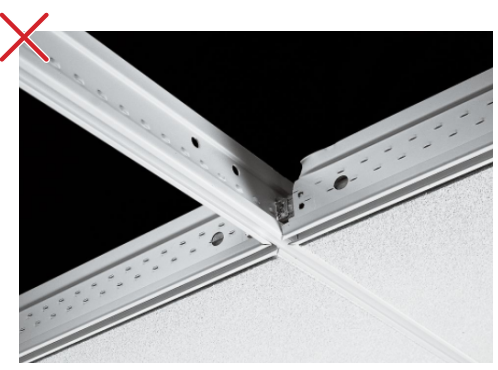

✗ Main Beam and Cross Tee sizes of 15/16"