



REFLECTOR/ FLANGED COLORS



WH-WH-White



BK-BK-Black



WH-BK-White/Black



BK-WH-Black/White

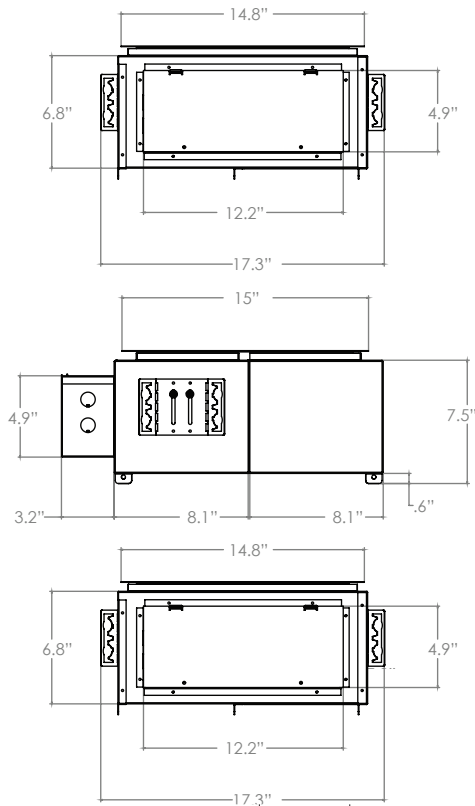

NOMINAL LUMENS	ELITE	LEDEngine
1500	18W	
1200	14W	
1100	-	15W
900	10W	-

Based on 4000K, 90+ CRI. Actual wattage may vary +/- 5%

FEATURES

A recessed multiple combo light with unlimited features, available in 1, 2, 3 or 4 heads, with precise, glare-free illumination. Each individual luminaire has full aiming adjustability, allowing for 365-degree rotation and a 60-degree pivot that locks into place at any desired position. Each luminaire can be specifically designed to fit the appropriate application; combining different optics, lumen packages, technologies, or color temperatures in a single housing. With an array of color temperatures, it can accentuate the full spectrum of cool to warm tones, and is the ideal solution for retail merchandising, hospitality, supermarkets, commercial, or high-end residential.

LUMENS	Elite Platform: 900, 1200, 1500 LED Engin Platform: 1100
TUNABLE WHITE PLATFORM	High Performance: TWH-50K-27K (50K to 27K) : TWH-65K-27K (65K to 27K) LED Engin: TWH-LENGN-65K-18K (65K to 18K)
CRI	90+ Standard
COLOR QUALITY	2 Step MacAdam Ellipses
DISTRIBUTION PATTERNS	SP (Spot), NFL (Narrow Flood), FL (Flood)
TRIM OPTIONS	1,2,3,4 Trim, Trimless
REFLECTOR COLORS	BK(Black), WH(White)
FLANGE COLORS	BK(Black), WH(White), Custom RAL Colors.
DIMMING	1% Dimming Standard, 0-10V (DIM10), DMX-512 DMX-RDM, BLE, LUTECO, DALI, DLM
EMERGENCY	10W - Bodine BSL310 20W - Bodine BSL20
LIFETIME	102,000 Hours
PHOTOMETRIC TESTS	In Accordance with IES LM79-08, LM80 and TM-30, TM-21

FL: FLOOD
Candlepower Distribution Curve

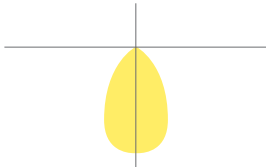

NFL: NARROW FLOOD
Candlepower Distribution Curve

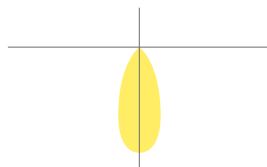

SP: SPOT
Candlepower Distribution Curve

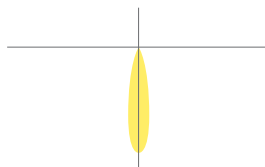

WALL WASH
Candlepower Distribution Curve

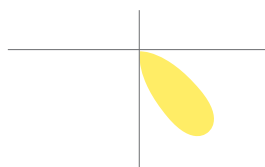

OPTICS AND REFLECTOR

A multi-segmented reflector allows for precise beam control, and offers field changeable optics in Narrow Spot, Narrow Flood, and Flood, with a variety of lumen options. With exceptional flexibility and controlled optics, each luminaire head can be positioned as a source for task, accent, or general illumination. Merchandising is consistently being rearranged, and the multiple combo is the perfect source for highlighting up to 4 different displays with a single housing. Trim options include trim or trimless, with black or white interior finish.

AIMING

The proprietary hot aiming system allows each individual head to be rotated 365 degrees horizontally and 45 degrees vertically, which can be locked into position without the use of tools.

HOUSING

Thermally protected for new construction, non-insulated ceilings or where insulation can be kept 3" from housing, with the ability to vertically adjust to accommodate various ceiling heights. It is fabricated from 18-gauge steel and post-painted, and each luminaire head is fabricated of die-cast aluminum to dissipate heat.

TRIM OPTION

Post-painted powder coated Die-Cast trim ring available in white and custom RAL colors. (Please consult factory for custom paint color options). Trim attaches to the housing with piano springs for snug fit and zero light leakage

TRIMLESS OPTION

Die-Cast perforated mesh cover intended for installation in drywall or plaster ceilings. Mudding may be applied right up to the edge of the luminaire opening to provide a seamless appearance. Trimless accessory is secured to the housing to prevent fractures in the ceiling and/or drywall during and after installation.

MOUNTING FRAME & BRACKET

Pre-installed butterfly brackets can be adjusted vertically with C-Channel mounting bars, allowing housing to be positioned and locked at any point within a 24" joist span. Bar hangers can fit onto a T-Bar spline with additional slots and holes for special mounting methods.

THERMAL MANAGEMENT SYSTEM

Passive cooling Die-cast Aluminum Heat Sink, LED light engine and driver are replaceable, upgradeable, and can be accessed from below the ceiling. The consistency in the quality of light is delivered with precision performance by the use of a unique locking mechanism that aligns the reflector with the light engine.

DRIVER ELECTRICAL INFORMATION

The LED driver is rated for 50 to 60Hz at 120V/277V input, produces less than 20%THD, and has a power factor between 90% and 100%, and is thermally protected for additional safety. Junction box and Driver can be accessed from below the ceiling and above the ceiling. Junction Box is Listed for through branch circuit wiring.

LISTINGS

c-UL-us - Listed for Feed Through Wiring.

DIMMING & DRIVER INFORMATION

SMART WHITE High Performance platform with a tuning range of 5000K to 2700K (TWH-50K-27K).

Control via DIM10 (0-10V), ELITE-CONNECT 0-10V, LUTRON, DMX512-RDM, DALI

LED Engin platform with tuning range of 6500K to 1800K (TWH-LENGN-65K-18K).

Control via DIM10, ELITE-CONNECT 0 10V, DMX512, DMX-RDM, BLE, DALI

Control via DIM10, DMX512-RDM, LUTECO, BLE, DALI, DLM

Junction box and Driver can be accessed from below the ceiling and above the ceiling. Junction Box is Listed for through branch circuit wiring.

WARRANTY

Five-year carefree warranty for parts and components. (Labor not included.)

LED DYNAMIC PLATFORM OPTIONS





SMART WHITE - Tunable White with Smart White technology allows the tuning of luminaires to mimic the natural color patterns throughout the day, enhancing interior office spaces, hospitality, and architectural elements. Tuning of intensity and color in classrooms enables a diversification in student activities, while the use of tunable white technology in healthcare stimulates circadian rhythm, accelerating the healing process. Complementing colors and textures in retail merchandising also has an impact on sales, utilizing the technology to adjust colors throughout the season. A CRI of 90+ is standard, and available on all three platforms. Elite Platform (50K-27K), and LED Engin Platform (65K-18K)

EXAMPLE: FCL-LED-TWH-50K-27K-2000L-DIM10-FL-90-F-WH-BK

SERIES	LUMEN	DIMMING	VOLTAGE	OPTICS	CRI	TRIM OPTION	TRIM COLOR	INTERIOR COLOR	ACCESSORIES
<input type="checkbox"/> FCL-LED-TWH-50K-27K <input type="checkbox"/> FCL-LED-TWH-65K-27K	<input type="checkbox"/> 900L <input type="checkbox"/> 1200L <input type="checkbox"/> 1500L	<input type="checkbox"/> DIM10 <input type="checkbox"/> DMX-512 <input type="checkbox"/> DMX-RDM <input type="checkbox"/> DALI <input type="checkbox"/> LUTH	<input type="checkbox"/> 120 <input type="checkbox"/> 277	<input type="checkbox"/> SP- Spot-15° <input type="checkbox"/> NFL- Narrow Flood-24°-25° <input type="checkbox"/> FL- Flood-36°-38°	<input type="checkbox"/> 90+	<input type="checkbox"/> F (Flanged) <input type="checkbox"/> TL (Trimless)	<input type="checkbox"/> WH (White) <input type="checkbox"/> BK (Black)	<input type="checkbox"/> WH (White) <input type="checkbox"/> BK (Black)	<input type="checkbox"/> BP31- 24" C-channel bar hangers
<input type="checkbox"/> FCL-LED-TWH-LENGN-65K-18K	<input type="checkbox"/> 1100L	<input type="checkbox"/> DIM10 <input type="checkbox"/> DMX-512 <input type="checkbox"/> DMX-RDM <input type="checkbox"/> DALI <input type="checkbox"/> BLE							

CONTROL OPTIONS

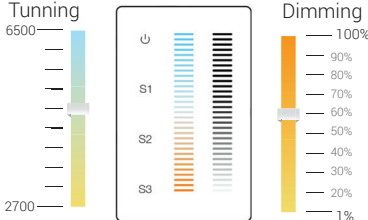
With the integration of controls, Elite Lighting now offers its products with controls-ready performance that increases energy efficiency, smarter space planning, and the enhancement of safety and productivity in the workplace. By utilizing these controls, Elite Lighting fixtures enable your customer's facility to run smarter, with the use of an easily controlled system through any platform.

CONTROL PROTOCOLS	SMART WHITE	LEDENGIN
<p><input type="checkbox"/> ELITE-CONNECT (EC-WC-TWH-HW-MVOLT) - Hard-wired, 0-10V, 120/277V wall mounted controller for CCT Tuning and Intensity Dimming through Simple Touch screen pad, provided by Elite Lighting. Programmable for up to 3-scenes, with a dimming range down to 1%. Applicable for office spaces, hospitality, educational, health care, and retail merchandising.</p> 	✓	✓
<p><input type="checkbox"/> DIM10 (0-10V 1% Dimming Standard) In order to Control the Color Tuning and dimming option with 0-10V driver you must dedicate two control inputs, one for the Dimming Control and another for CCT Tuning. Can be dimmed and tuned with 2 wall box dimmers and or daylight harvesting systems.</p> <p><input type="checkbox"/> DIM10-LUTRON Compatible with Lutron GRAFIK Eye QS or GRAFIK Eye 3000 by using two GRX-TVI Lutron 0-10V Dimming interfaces; one to tune and another to control dimming. Also compatible with Lutron VIVE system by using two FCJS-010 PowPak or FCJS-ECO EcoSystem PowPak modules per fixture; one to tune and one to control dimming.</p> 	✓	✓
<p><input type="checkbox"/> DMX (Available on Elite, LED Engin platforms) - Compatible with Digital Multiplex Controller, Available with two options: DMX-512: Standard DMX Controller and DMX-RDM: DMX Controller with Remote Device Management.</p>	✓	✓
<p><input type="checkbox"/> LUTEKO Compatible with Lutron EcoSystem. Compatible with Lutron GRAFIK Eye EcoSystem, Lutron Energi Saver node EcoSystem, or Lutron Quantum systems.</p>	✓	N/A
<p><input type="checkbox"/> DALI Compatible with Digital Addressable Lighting Interface, available with two options: DT6 and DT8.</p>	✓	✓
<p><input type="checkbox"/> DLM The combination of the Blanco 3 with DLM from Legrand Wattstopper enables simple commissioning, synonymous with DLM and the enhanced features and flexibility.</p>	N/A	N/A