



* For list of qualified DLC fixture, please consult factory

7000 LUMENS	10000 LUMENS	12000 LUMENS	15000 LUMENS	20000 LUMENS	28000 LUMENS	31000 LUMENS	34000 LUMENS	40000 LUMENS
48 WATT	66 WATT	99 WATT	104 WATT	145 WATT	192 WATT	227 WATT	240 WATT	283 WATT
According to DLC Test Results	According to DLC Test Results	According to DLC Test Results	According to DLC Test Results	According to DLC Test Results	According to DLC Test Results	According to DLC Test Results	According to DLC Test Results	According to DLC Test Results

The HD1B-LED is an enclosed LED powered high-lumen lighting fixture designed for use in food processing facilities, sports complexes, warehouses, outdoor canopies, cold storage facilities, and manufacturing facilities. The HD1B-LED is suitable for a wide range of high bay applications and an ideal and more efficient replacement for 150-400W metal halide, high pressure sodium, and fluorescent lighting systems.

PRODUCT FEATURES:

- Contoured component surfaces reduce the buildup of debris and permit easy cleaning
- Symmetrically hinged universal gear tray for trouble-free maintenance
- Stainless steel cam-action latches come standard, optional tamper-proof screws available
- Available with specular reflector as option
- Mounting bracket included for surface mount installation
- The back of the housing has a 10 degree slope to satisfy the requirements in the food industry which are more stringent than NSF standards
- LED reflectors are painted with an 87% reflective white coat to improve fixture efficacy
- Rated at 85+ CRI and available in multiple CCTs
- Life tested to ensure light output up to 50,000 hours of operation to L70
- Tested to LM-79 and LM-80 standards
- Dimmable down to 5%-10% with compatible dimming systems

- LED lighting technology offers the highest return on initial investment over the lifetime of the fixture
- Emergency battery back-up comes pre-installed on the fixture and emergency push button is installed on the fixture for easy access and aesthetics.
- UL and cUL recognized
- NSF Splash Zone 2
- Wet location listed: IP65 per IEC 60529 standard, IP67 per IEC 60529 standard, IP66
- NEMA 4X
- NSF International certified for NSF/ANSI Standard 2 – Food Equipment and Splash Zone 2
- UL 5VA flammability rated
- F1 weatherability rated
- Operating temperature: -40°C to 55°C (-40°F to 131°F), unless used in vandal area or where easily hit

OPTICS - The frosted lens of the HD1B-LED helps to deliver a volumetric light that helps fill an entire indoor space with light, giving it a larger, brighter, and more productive ambiance. The contoured high-impact resistance lens features molded linear ridges to diffuse the lamp image and minimize glare. HD1B is also available from a clear lens.

ELECTRICAL - Powered by high-quality constant-current power LED drivers which are rated for 50 to 60Hz at 120-277V input, produce less than 20% THD, and have a power factor of .90 to 1.00.

DURABILITY - The HD1B-LED housing is made of a solid piece of reinforced polyester rated to UL 5VA flammability and F1 weatherability standards. Housing and lens connecting channel are sealed with a continuous En-Seal™ poured gasket to ensure conformity to all weathering standards. Lens is made from an impact resistant polycarbonate material to ensure LED light engines are safe from dust, moisture and/or accidental impact.

MAINTENANCE - LED engines and driver can be accessed through the bottom by removing hinged door tray and reflector. LED engines are removable and upgradable even after fixture installation. Fixture can be regularly and safely wiped down to ensure optimal fixture performance.

PERFORMANCE - The HD1B-LED powered lighting technologies offer a higher return on investment than any other lighting technology. The light engines found in the HD1B-LED are rated at 85+ CRI and available in multiple CCTs: 3000K, 3500K, 4000K and 5000K. All LEDs and LED fixtures are rated and tested to LM-79 and LM-80 standards. The LEDs are also binned to a 3-step MacAdam ellipses to achieve consistent color from fixture to fixture.

OPTIONS - Fixtures can be shipped pre-installed with daylight harvesting controls, occupancy sensors, and/or power pack. Available manufacturer options include Leviton, Hubble Automation, and others. The Wattstopper - **MS-FM105** Super High Frequency Occupancy Sensor is a line voltage sensor that turns lighting on and off based on occupancy, and can hold lights off when sufficient daylight is available. Include two stainless steel mounting brackets for surface, stem, suspended chain, aircraft cable, and other mounting options. Consult factory for details.

THERMAL MANAGEMENT - LED light engines are attached directly to aluminum reflector housing which keeps the engines cool. Our advanced thermal management system allows the light output of the LED engines to be maintained at 70% of initial lumens at 50,000 hours of operation.

QUALITY CONTROL - Every fixture is turned on and rigorously tested by our QC Department before shipping.

DIMMING - The HD1B-LED comes standard with 0-10V dimming on either 120 or 277V. Dimmable down to 5%-10% of initial lumens. Consult factory for dimmer compatibility.

WARRANTY - Limited 5 Year Warranty*

Ordering Information: Example: HD1B-LED-5000L-DIM10-120-30K

SERIES	DIMMING	VOLTAGE	CCT	CRI	EMERGENCY	DISTRIBUTION	OTHER OPTIONS																																																																																
HD1B-LED- Oracle LED High Beam Hose Down High Bay	DIM10 - 1-10V Dimming	MVOLT 347* 480	30K - (3000K) 35K - (3500K) 40K - (4000K) 50K - (5000K)	85	0-EMG-LED	Blank - General ND - Narrow Distribution MD - Medium Distribution WD - Wide Batwing Distribution AD - Aisle Distribution	INMS - Internal Motion Sensor MSPH - Motion Sensor W/ Photocell WLMS - Wet Location Motion Sensor TPS - Tamper Proof Screws USA - Made in America Compliance FSP-311-B-D - 0-10V continuous dimming PIR photo/motion sensor with bluetooth control option.																																																																																
<table border="1"> <thead> <tr> <th colspan="2">SERIES</th> <th colspan="2">WIRING OPTIONS</th> <th colspan="2">LENS AND REFLECTOR OPTIONS</th> <th colspan="2">SUSPENSION MOUNTING</th> </tr> </thead> <tbody> <tr> <td>7000L*</td> <td>(7715 lumens)</td> <td>PCSB120</td> <td>10' Nema 5-15R 120V Straight Blade Plug</td> <td>IPTL120</td> <td>10' 120V IP Rated Twist lock Plug</td> <td>(blank)</td> <td>Frosted Lens w/ White Reflector Standard</td> </tr> <tr> <td>10000L</td> <td>(9200 lumens)</td> <td>PCSB277</td> <td>10' Nema 7-15R 277V Straight Blade Plug</td> <td>IPTL277</td> <td>10' 277V IP Rated Twist lock Plug</td> <td>HD1BCL</td> <td>Clear Lens w/ White Reflector Standard</td> </tr> <tr> <td>12000L</td> <td>(13800 lumens)</td> <td>PCTL120</td> <td>10' Nema L5-15R 120V Twist Lock Plug</td> <td>S01</td> <td>10' 120V/277V SO Cord</td> <td>4HD1BSR</td> <td>Specular Reflector</td> </tr> <tr> <td>15000L</td> <td>(14500 lumens)</td> <td>PCTL277</td> <td>10' Nema L5-15R 277V Twist Lock Plug</td> <td>S02</td> <td>10' 480V SO Cord</td> <td></td> <td></td> </tr> <tr> <td>20000L</td> <td>(20200 lumens)</td> <td></td> <td></td> <td></td> <td></td> <td></td> <td></td> </tr> <tr> <td>28000L</td> <td>(26700 lumens)</td> <td></td> <td></td> <td></td> <td></td> <td></td> <td></td> </tr> <tr> <td>31000L</td> <td>(31600 lumens)</td> <td></td> <td></td> <td></td> <td></td> <td></td> <td></td> </tr> <tr> <td>34000L</td> <td>(33350 lumens)</td> <td></td> <td></td> <td></td> <td></td> <td></td> <td></td> </tr> <tr> <td>40000L</td> <td>(40000 lumens)</td> <td></td> <td></td> <td></td> <td></td> <td></td> <td></td> </tr> </tbody> </table>								SERIES		WIRING OPTIONS		LENS AND REFLECTOR OPTIONS		SUSPENSION MOUNTING		7000L*	(7715 lumens)	PCSB120	10' Nema 5-15R 120V Straight Blade Plug	IPTL120	10' 120V IP Rated Twist lock Plug	(blank)	Frosted Lens w/ White Reflector Standard	10000L	(9200 lumens)	PCSB277	10' Nema 7-15R 277V Straight Blade Plug	IPTL277	10' 277V IP Rated Twist lock Plug	HD1BCL	Clear Lens w/ White Reflector Standard	12000L	(13800 lumens)	PCTL120	10' Nema L5-15R 120V Twist Lock Plug	S01	10' 120V/277V SO Cord	4HD1BSR	Specular Reflector	15000L	(14500 lumens)	PCTL277	10' Nema L5-15R 277V Twist Lock Plug	S02	10' 480V SO Cord			20000L	(20200 lumens)							28000L	(26700 lumens)							31000L	(31600 lumens)							34000L	(33350 lumens)							40000L	(40000 lumens)						
SERIES		WIRING OPTIONS		LENS AND REFLECTOR OPTIONS		SUSPENSION MOUNTING																																																																																	
7000L*	(7715 lumens)	PCSB120	10' Nema 5-15R 120V Straight Blade Plug	IPTL120	10' 120V IP Rated Twist lock Plug	(blank)	Frosted Lens w/ White Reflector Standard																																																																																
10000L	(9200 lumens)	PCSB277	10' Nema 7-15R 277V Straight Blade Plug	IPTL277	10' 277V IP Rated Twist lock Plug	HD1BCL	Clear Lens w/ White Reflector Standard																																																																																
12000L	(13800 lumens)	PCTL120	10' Nema L5-15R 120V Twist Lock Plug	S01	10' 120V/277V SO Cord	4HD1BSR	Specular Reflector																																																																																
15000L	(14500 lumens)	PCTL277	10' Nema L5-15R 277V Twist Lock Plug	S02	10' 480V SO Cord																																																																																		
20000L	(20200 lumens)																																																																																						
28000L	(26700 lumens)																																																																																						
31000L	(31600 lumens)																																																																																						
34000L	(33350 lumens)																																																																																						
40000L	(40000 lumens)																																																																																						

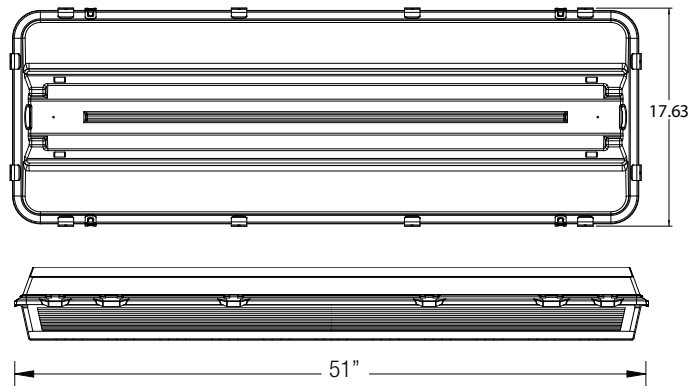
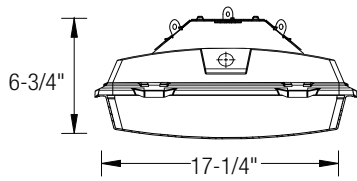

HD1B-LED-5000L-DIM10-MVOLT-40K-85

TEST NO.: **EL09101962**

INPUT WATTS: **35.6** LUMENS: **5146** CRI: **85** EFFICACY: **145** CCT: **4000K**

SPACING CRITERIA: **1.36**

Candle Power Distribution (Candelas)

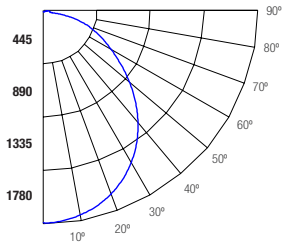

Zonal Lumens Summary

Zone	Lumens	%Lamp	%Fixt
0-20	649.45	12.60	12.60
0-30	1377.38	26.80	26.80
0-40	2243.3	43.60	43.60
0-60	3870.36	75.20	75.20
0-80	4801.96	93.30	93.30
0-90	4963.76	96.50	96.50

Luminance (Average candela/M²)

Angle in Degrees	Average 0°	Average 45°	Average 90°
45	3518	3543	3502
55	3231	3237	3159
65	3061	2933	2798
75	3241	2841	2472
85	4343	3573	2435

Lumens Per Zone

Zone	Lumens
0-10	168.03
10-20	481.43
20-30	727.93
30-40	865.91
40-50	870.39
50-60	756.68
60-70	569.39
70-80	362.21
80-90	161.80

Candela Tabulation

0	
0.0	1776.722
5.0	1769.630
15.0	1700.140
25.0	1567.310
35.0	1367.860
45.0	1110.450
55.0	827.100
65.0	577.470
75.0	374.360
85.0	168.970
90.0	96.970

Coefficients of Utilization - Zonal Cavity Method

Effective Floor Cavity Reflectance 0.20

RC RW	80%				70%				50%			30%			10%			0%			
	70%	50%	30%	10%	70%	50%	30%	10%	50%	30%	10%	50%	30%	10%	50%	30%	10%	50%	30%	10%	
0	118	118	118	118	115	115	115	115	109	109	109	104	104	104	99	99	99	96	96	96	96
1	107	103	98	94	104	100	96	92	95	92	89	90	88	85	86	84	82	80	80	80	80
2	98	89	82	77	95	87	81	75	83	78	73	79	75	71	76	72	69	66	66	66	66
3	89	78	70	64	86	77	69	63	73	67	61	70	64	60	67	62	58	56	56	56	56
4	82	70	61	54	79	68	60	53	65	58	52	62	56	51	60	54	50	48	48	48	48
5	75	62	53	47	73	61	52	46	58	51	45	56	50	44	54	48	44	41	41	41	41
6	69	56	47	41	67	55	46	40	53	45	40	51	44	39	49	43	38	36	36	36	36
7	64	51	42	36	62	50	42	36	48	41	35	46	40	35	45	39	34	32	32	32	32
8	60	46	38	32	58	46	38	32	44	37	31	42	36	31	41	35	31	29	29	29	29
9	56	43	34	29	54	42	34	29	40	33	28	39	33	28	38	32	28	26	26	26	26
10	52	39	31	26	51	39	31	26	37	31	26	36	30	25	35	29	25	23	23	23	23

RC - Ceiling Cavity Reflectance

HD1B-LED-7000L-DIM10-MVOLT-40K-85

TEST NO.: **EL09101961**

INPUT WATTS: **49.8** LUMENS: **6991** CRI: **85** EFFICACY: **140** CCT: **4000K**

SPACING CRITERIA: **1.36**

Candle Power Distribution (Candelas)

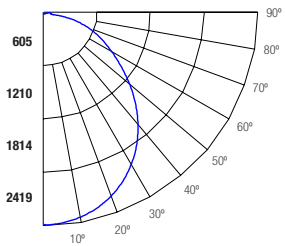

Zonal Lumens Summary

Zone	Lumens	%Lamp	%Fixt
0-20	883.08	12.60	12.60
0-30	1872.96	26.80	26.80
0-40	3050.59	43.60	43.60
0-60	5258.04	75.20	75.20
0-80	6523.73	93.30	93.30
0-90	6744.26	96.50	96.50

Luminance (Average candela/M²)

Angle in Degrees	Average 0°	Average 45°	Average 90°
45	4782	4818	4775
55	4388	4399	4314
65	4161	3983	3821
75	4355	3818	3351
85	5910	4859	3368

Lumens Per Zone

Zone	Lumens
0-10	228.44
10-20	654.64
20-30	989.88
30-40	1177.63
40-50	1183.88
50-60	1023.57
60-70	773.68
70-80	492.00
80-90	220.54

Candela Tabulation

0	
0.0	2415.337
5.0	2405.040
15.0	2311.530
25.0	2129.920
35.0	1858.530
45.0	1509.360
55.0	1123.350
65.0	784.940
75.0	503.130
85.0	229.910
90.0	132.260

Coefficients of Utilization - Zonal Cavity Method

Effective Floor Cavity Reflectance 0.20

RC RW	80%				70%				50%			30%			10%			0%			
	70%	50%	30%	10%	70%	50%	30%	10%	50%	30%	10%	50%	30%	10%	50%	30%	10%	50%	30%	10%	
0	118	118	118	118	115	115	115	115	109	109	109	104	104	104	99	99	99	96	96	96	96
1	107	103	98	94	104	100	96	92	95	92	89	90	88	85	86	84	82	80	80	80	80
2	98	89	82	77	95	87	81	75	83	78	73	79	75	71	76	72	69	66	66	66	66
3	89	78	70	64	86	77	69	63	73	67	61	70	64	60	67	62	58	56	56	56	56
4	82	70	61	54	79	68	60	53	65	58	52	62	56	51	60	55	50	48	48	48	48
5	75	62	53	47	73	61	52	46	58	51	45	56	50	45	54	48	44	41	41	41	41
6	69	56	47	41	67	55	47	40	53	45	40	51	44	39	49	43	38	36	36	36	36
7	64	51	42	36	62	50	42	36	48	41	35	46	40	35	45	39	34	32	32	32	32
8	60	46	38	32	58	46	38	32	44	37	32	42	36	31	41	35	31	29	29	29	29
9	56	43	34	29	54	42	34	29	40	33	28	39	33	28	38	32	28	26	26	26	26
10	53	39	31	26	51	39	31	26	37	31	26	36	30	26	35	29	25	23	23	23	23

RC - Ceiling Cavity Reflectance

RW - Wall Reflectance

*Warranty is contingent on the correct application and installation of fixture.

LED
HD1B

LED Wet Location Vapor Tight

HD1B-LED-10000L-DIM10-MVOLT-40K-85

INPUT WATTS: **71.3**

LUMENS: **10195**

CRI: **85**

EFFICACY: **143**

CCT: **4000K**

TEST NO.: **EL09121971**

SPACING CRITERIA: **1.36**

Candle Power Distribution (Candelas)

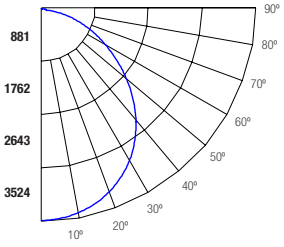

Zonal Lumens Summary

Zone	Lumens	%Lamp	%Fixt
0-20	1285.13	12.60	12.60
0-30	2724.8	26.70	26.70
0-40	4436.42	43.50	43.50
0-60	7642.87	75.00	75.00
0-80	9510.87	93.30	93.30
0-90	9832.82	96.40	96.40

Luminance (Average candela/M²)

Angle in Degrees	Average 0°	Average 45°	Average 90°
45	6838	6978	6986
55	6325	6366	6315
65	6233	5832	5584
75	6097	5648	4900
85	7833	7000	4935

Lumens Per Zone

Zone	Lumens
0-10	332.54
10-20	952.60
20-30	1439.66
30-40	1711.63
40-50	1718.23
50-60	1488.22
60-70	1138.64
70-80	729.35
80-90	321.95

Candela Tabulation

0	
0.0	3516.267
5.0	3499.220
15.0	3352.740
25.0	3078.210
35.0	2673.300
45.0	2158.220
55.0	1619.350
65.0	1175.840
75.0	704.300
85.0	304.730
90.0	177.470

Coefficients of Utilization - Zonal Cavity Method

Effective Floor Cavity Reflectance 0.20

RC RW	80%				70%				50%			30%			10%			0%
	70%	50%	30%	10%	70%	50%	30%	10%	50%	30%	10%	50%	30%	10%	50%	30%	10%	0%
0	118	118	118	118	115	115	115	115	109	109	109	104	104	104	99	99	99	96
1	107	102	98	94	104	100	96	92	95	92	89	90	88	85	86	84	82	80
2	98	89	82	76	95	87	81	75	83	78	73	79	75	71	76	72	69	66
3	89	78	70	64	86	77	69	63	73	67	61	70	64	60	67	62	58	56
4	82	69	61	54	79	68	60	53	65	58	52	62	56	51	60	54	50	48
5	75	62	53	46	73	61	52	46	58	51	45	56	49	44	54	48	44	41
6	69	56	47	41	67	55	46	40	53	45	40	51	44	39	49	43	38	36
7	64	51	42	36	62	50	42	36	48	41	35	46	40	35	45	39	34	32
8	60	46	38	32	58	46	37	32	44	37	31	42	36	31	41	35	31	29
9	56	43	34	29	54	42	34	29	40	33	28	39	33	28	38	32	28	26
10	52	39	31	26	51	39	31	26	37	30	26	36	30	25	35	29	25	23

RC - Ceiling Cavity Reflectance

RW - Wall Reflectance

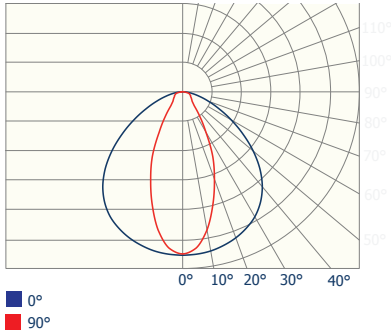

NARROW 30 DEGREE

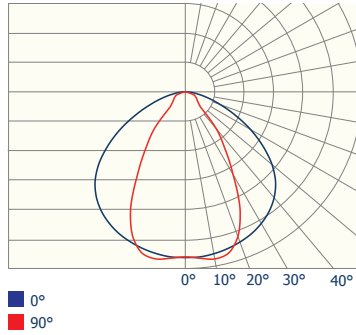

MEDIUM 60 DEGREE

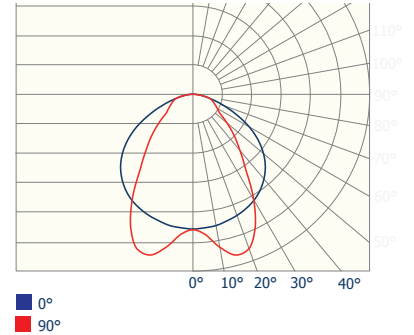

AISLE LIGHT 15 DEGREE

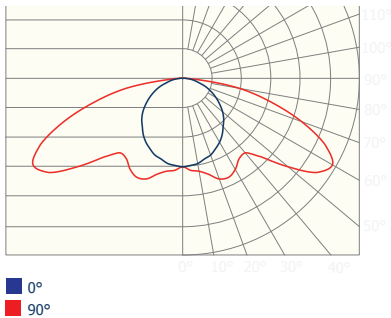

**WIDE BATWING 120 /
PARKING GARAGE**

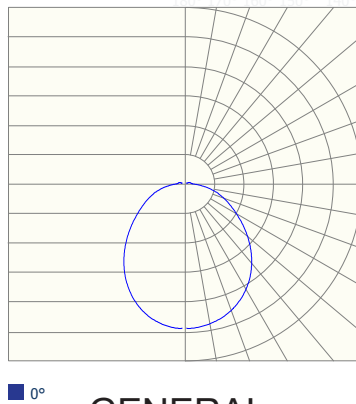

GENERAL