

HC-FT

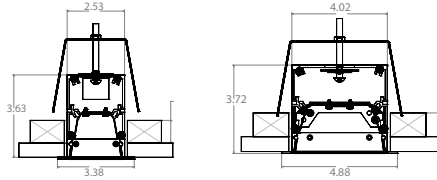

HC-TL

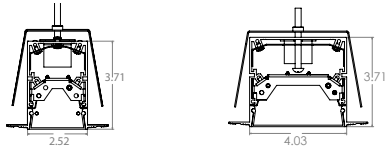

TB-1516-FT

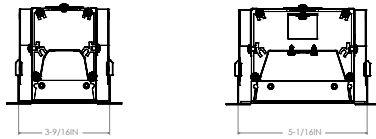

TB-SG

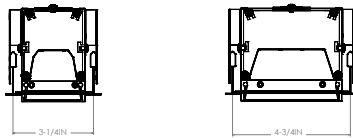

2" PROFILES

4" PROFILES

LUMENS/FT	ELITE
1000	9.5
750	6.5
500	4.5



DYNAMIC PLATFORM

SMART WHITE - Tunable White with Smart White technology allows the tuning of luminaires to mimic the natural color patterns throughout the day, enhancing interior office spaces, hospitality, and architectural elements. Tuning of intensity and color in classrooms enables a diversification in student activities, while the use of tunable white technology in healthcare stimulates circadian rhythm, accelerating the healing process. Complementary colors and textures in retail merchandising also has an impact on sales, utilizing the technology to adjust colors throughout the season. A CRI of 90+ is standard, and available on all three platforms. Elite Platform (50K-27K).

LUMENS PER FOOT	Elite Platform: 500, 750, 1000
CCT & DYNAMIC PLATFORMS	High Performance: TWH-50K-27K High Performance: TWH-65K-27K
CRI	90+ Standard
COLOR QUALITY	2 Step MacAdam Ellipses
WIDTHS	2", 4"
LENGTHS	2', 4', 6', 8', Custom
DISTRIBUTION PATTERNS	Standard, Wall Wash
CONFIGURATION PATTERNS & LENGTHS	Single, Continuous, Square, Rectangular, L-Shape, Custom with 90, 60, or 45 ° Angles, Ceiling, Wall, Wall to Ceiling
MOUNTING	Recessed Trim, Recessed Trimless
FINISH	WH (White), BK (Black), SI (Silver), Custom RAL
DIMMING & CONTROLS	0-10V Flicker Free 1% Dimming (DIM10), DMX-512 DMX-RDM, BLE, LUTH, DALI, DLM
EMERGENCY	10W - Up to 1000L Output (Bodine BSL310) 20W - Up to 2000L Output (Bodine BSL20)
LIFETIME	L70 at 50,000 Hours
PHOTOMETRIC TESTS	In Accordance with IES LM79-08, LM80 and TM-30, TM-21

Distribution Pattern:
Standard

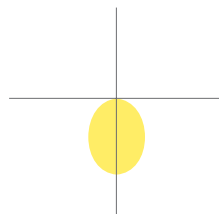

Distribution Pattern:
Wall Wash

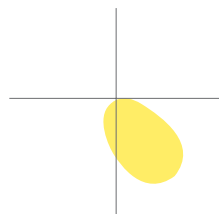

**FEATURES**

FLEX Architectural LED Recessed Linear delivers an endless array of flexibility, from straight runs to complex 90° turns. Available in small standard profiles of 2" and 4", or custom lengths, it accommodates drywall or T-bar installations, with fully illuminated corners to provide seamless, continuous lengths of light. Be inspired to create a long-lasting impression with a unique design that complements corporate offices, educational, commercial, and retail spaces.

OPTICS & PERFORMANCE

Fabricated from 20-gauge aluminum, with mitered corners, and post-painted with 95% reflective premium paint. The optical system delivers high efficiency LED light that passes through a high quality acrylic lens for optimal distribution patterns, creating a glare-free and even distribution. Distributions include Direct Downlight or Wall Wash with zero light leakage.

CONSTRUCTION

One-piece rigid aluminum extrusion, made of T6063-T5 aluminum, with cast aluminum end caps. A precision cut, smooth white extruded frosted lens with snap in design attaches firmly into the grooves of the body and can be easily removed for access to the driver and LED boards.

OPTICAL ASSEMBLY

Reflector is fabricated from 20-gauge aluminum, and post-painted finish with 95% reflective premium paint. Wall Wash reflectors are positioned at an angle.

DISTRIBUTION PATTERNS & DIFFUSER

Standard Distribution-A high-quality, smooth white frosted efficient acrylic lens is shipped standard for optimal distribution patterns, for most applications, and provides glare-free, even illumination.

Wall Wash Distribution-Illuminates from the ceiling, down, for uniform vertical illumination.

SMART WHITE

High Performance platform with a tuning range of 5000K to 2700K (TWH-50K-27K).

Control via DIM10 (0-10V), ELITE-CONNECT 0-10V, LUTRON, DMX512-RDM, DALI

CRM INSTALLATION

For continuous row mounting, the first luminaire in the row will always be the power supply feed. After plugging in the male and female harnesses, which are supplied with each luminaire, they will easily slide together, then secured with two screws from opposite directions in the connecting brackets.

DRIVER ELECTRICAL INFORMATION

Powered by high-quality constant-current power LED drivers which are rated for 50 to 60Hz at 120-277V input, produce less than 20% THD, and have a power factor of .90 to 1.00. Male and female 18-gauge 6 wire plug connectors are included with every luminaire to allow for simple hassle-free continuous wiring, and each luminaire must be installed male to female.

WARRANTY

Five-year warranty for parts and components. (Labor not included)

LISTINGS

c-UL-us - Listed for Feed Through Wiring.

All LED luminaires are rated and tested to LM-79 and LM-80 standards by an independent laboratory.







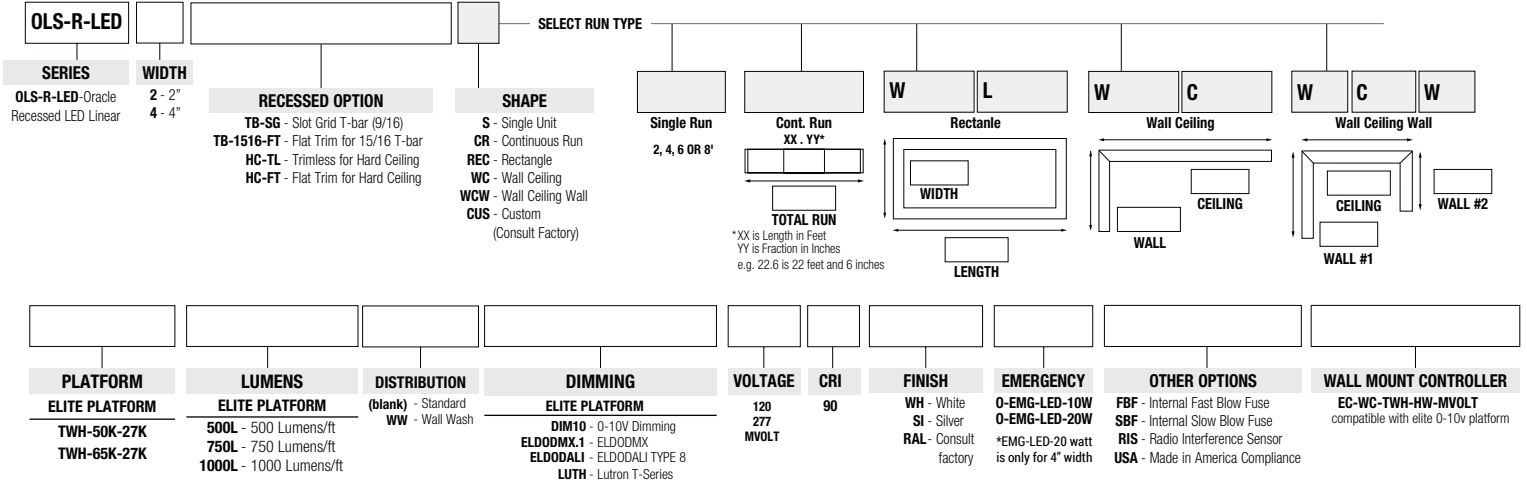



Example: **OLS-R-LED-2-TB-SG-REC-W8-L6-TWH-50K-27K-500L-DIM10-MVOLT**



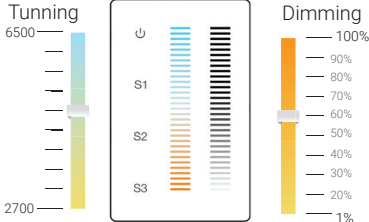

CONTROL OPTIONS

With the integration of controls, Elite Lighting now offers its products with controls-ready performance that increases energy efficiency, smarter space planning, and the enhancement of safety and productivity in the workplace. By utilizing these controls, Elite Lighting luminaires enable your customer's facility to run smarter, with the use of an easily controlled system through any platform.

CONTROL PROTOCOLS	SMART WHITE
<p><input type="checkbox"/> ELITE-CONNECT (EC-WC-TWH-HW-MVOLT) - Hard-wired, 0-10V, 120/277V wall mounted controller for CCT Tuning and Intensity Dimming through Simple Touch screen pad, provided by Elite Lighting. Programmable for up to 3-scenes, with a dimming range down to 1%. Applicable for office spaces, hospitality, educational, healthcare, and retail merchandising.</p> 	
<p><input type="checkbox"/> DIM10 (0-10V 1% Dimming Standard) In order to Control the Color Tuning and dimming option with 0-10V driver you must dedicate two control inputs, one for the Dimming Control and another for CCT Tuning. It can be dimmed and tuned with 2 wall box dimmers and compatible with most control systems and/or daylight harvesting systems.</p> <p><input type="checkbox"/> DIM10-LUTRON Compatible with Lutron GRAFIK Eye QS or GRAFIK Eye 3000 by using two GRX-TVI Lutron 0-10V Dimming interfaces; one to tune and another to control dimming. Also compatible with Lutron VIVE system by using two FCJS-010 PowPak or FCJS-ECO EcoSystem PowPak modules per luminaire; one to tune and one to control dimming.</p> 	
<p><input type="checkbox"/> DMX (Available on Elite, LED Engin) - Compatible with Digital Multiplex Controller, Available with two options; DMX-512: Standard DMX Controller and DMX-RDM: DMX Controller with Remote Device Management.</p>	
<p><input type="checkbox"/> LUTEKO Compatible with Lutron EcoSystem. Compatible with Lutron GRAFIK Eye EcoSystem, Lutron Energi Saver node EcoSystem, or Lutron Quantum systems.</p>	
<p><input type="checkbox"/> DALI Compatible with Digital Addressable Lighting Interface, available with two options: DT6 and DT8.</p>	



TWH-50K-27K

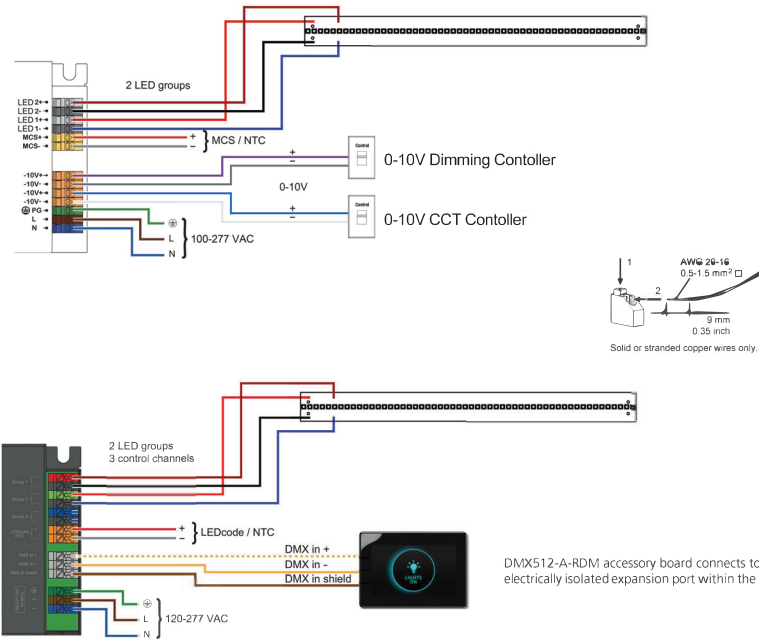

TWH Controller EC-WC-TWH-HW-MVOLT

Wiring Diagram:

AC 100-277V

LED 2+
LED 2-
LED 1+
LED 1-
MCS+
MCS-

2 LED groups

MCS / NTC

0-10V

100-277 VAC

L
N

AWG 20-16
0.5-1.5 mm² □

9 mm
0.35 inch

Solid or stranded copper wires only.

EC-WC-TWH-HW-MVOLT

100-277VAC Power input

DMX

BND

CCT

Control brightness

Control color temperature

Output Signal: 2x(1-10V) signal

Power Supply: 100-277VAC

Power consumption: 30 mA max

Operating temperature: 0-40°C

Relative humidity: 8% to 80%

Dimensions: 75x120x40.8mm

• 100-277VAC input.

• Touch slide tunable white and brightness control.

• 2 channels 1-10V signal output.

• 0.1%-100% dimming.

• Waterproof grade-IP20.

• Save up to max 3 different colors.

Safety & Warnings:

DO NOT install with power applied to device.

DO NOT expose the device to moisture.

Dual color slider, touch to adjust color temperature between Warm White and Cool White

Click to turn on/off

S1

S2

S3

Hold finger down until connected lighting flash to save colors. Short press on button to recall the saved color.

Brightness slider, touch to dim brightness, the lowest brightness is 1%.

Front side

31.85 mm

75.0 mm

49 mm

120.0 mm

83.20 mm

48.9 mm

Back side