

NOMINAL LUMENS	ELITE	LED ENGIN
2500	30 W	-
2000	24 W	29 W
1500	18 W	-
1200	14 W	-
1100	-	15 W
900	10 W	-

Based on 4000K, 90CRI with semi-specular chrome reflector.  
Actual wattage may vary +/-5%

**DYNAMIC PLATFORM**

SMART WHITE - Tunable White with Smart White technology allows the tuning of luminaires to mimic the natural color patterns throughout the day, enhancing interior office spaces, hospitality, and architectural elements. Tuning of intensity and color in classrooms enables a diversification in student activities, while the use of tunable white technology in healthcare stimulates circadian rhythm, accelerating the healing process. Complementing colors and textures in retail merchandising also has an impact on sales, utilizing the technology to adjust colors throughout the season. A CRI of 90+ is standard, and available on all three platforms. Elite Platform (50K-27K), LED Engin Platform (65K-18K)

LUMENS	Elite Platform: 900, 1200, 1500, 2000 & 2500 LED Engin Platform: 1100 & 2000
CCT & DYNAMIC PLATFORMS	High Performance: TWH-50K-27K (50K to 27K) LED Engin: TWH-LENGN-65K-18K (65K to 18K)
CRI	90+ Standard
COLOR QUALITY	2 Step MacAdam Ellipse
DISTRIBUTIONS	VWD, WD, MWD, MD, ND, SPD, NSPD
MOUNTING OPTIONS	CM (Ceiling Mount), WM (Wall Mount), PM (Pendant Mount), SM (Suspended Mount)
BODY FINISHES	WH (White), BK (Black), BZ (Bronze), SI (Silver), Custom RAL
REFLECTOR COLORS	CL (Semi-Specular Chrome), SHZ (Low Iridescent Satin Haze), WT (Wheat), W (White), MB (Black)
DIMMING	1% Dimming Standard, 0-10V (DIM10), DMX-512 DMX-RDM, BLE, LUTECO, DALI, DLM
EMERGENCY	10W - Up to 1000L Output (Bodine BSL310) 20W - Up to 2000L Output (Bodine BSL20)
LIFETIME	L70 at 50,000 Hours
PHOTOMETRIC TESTS	In Accordance with IES LM79-08 and LM80, TM-30, TM-21

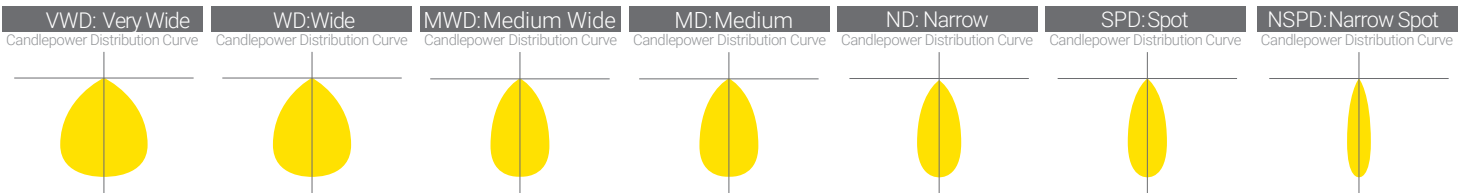

Reference IES files for additional distribution curve information.





**FEATURES**

A highly sustainable and ultra-efficient architectural LED Cylinder that provides even, glare-free illumination. Available in a range of mountings, finishes, distributions, and lumen packages, it is ideally suited for use in corporate office space, hospitality, healthcare, commercial, academic, churches, airports and retail merchandising.

**OPTICS AND REFLECTOR**

The reflector has a 45° cutoff, and is shipped standard with a Solite lens in a smooth frosted finish. It is spun from 0.05" thick aluminum, has a 1-step anodized finish, and is available in different colors or custom RAL finishes. Reflector trim options include selfflanged and white painted flange. Various distribution options are available, and all optics are field changeable

**CONSTRUCTION**

The cylinder body comes standard with a post-painted mate white finish and die-formed construction for maximum heat dissipation and rust protection. Other standard finishes and custom colors are also available.

**THERMAL MANAGEMENT SYSTEM**

Passive cooling Diecast Aluminum Heat Sink, LED light engine and driver are replaceable, upgradeable, and can be accessed from below the ceiling. The consistency in the quality of light is delivered with precision performance by the use of a unique locking mechanism that aligns the reflector with the light engine.

**MOUNTING OPTIONS**

Ceiling mount bracket provided for direct installation with 3-1/4" to 4" octagonal and square junction box. Pendant mount option is supplied with a 5" diameter canopy cover. Suspended mount option is supplied with an aircraft adjustable cable, and is ideal for sloped ceiling applications up to 45 degrees.

**DIMMING & DRIVER INFORMATION**

**SMART WHITE** - High Performance platform with a tuning range of 5000K to 2700K (TWH-50K-27K).

Control via DIM10 (0-10V), ELITE-CONNECT 0-10V, LUTRON, DMX512-RDM, DALI

**LED Engin** - platform with tuning range of 6500K to 1800K (TWH-LENGN-65K-18K).

Control via DIM10, ELITE-CONNECT 0 10V, DMX512, DMX-RDM, BLE, DALI! Junction box and driver can be accessed from below the ceiling and above the ceiling. Junction box is listed for through branch circuit wiring.

**DRIVER ELECTRICAL INFORMATION**

The LED driver is rated for 50 to 60Hz at 120V/277V input, produces less than 20%THD, has a power factor between 90% and 100%, and is thermally protected for additional safety. Junction box and Driver can be accessed from below the ceiling and above the ceiling. Junction Box is Listed for through branch circuit wiring.

**WARRANTY**

Five-year warranty for parts and components. (Labor not included)

**LISTINGS**

c-UL-us - Listed for Feed Through Wiring.



Example: **SCH10-LED-TWH-50K-27K-900L-DIM10-120-MD-90-WH-CM-HH10-1501-CL-WH**

SERIES	LUMENS	DRIVER	VOLTAGE	BODY FINISHES	MOUNTING OPTIONS	EMERGENCY	TRIM TYPES	REFLECTOR/ FLANGE COLORS	WALL MOUNT CONTROLLER																
SCH10-LED-TWH-50K-27K	<input type="checkbox"/> 900L <input type="checkbox"/> 1200L <input type="checkbox"/> 1500L <input type="checkbox"/> 2000L <input type="checkbox"/> 2500L	<input type="checkbox"/> DIM10* <input type="checkbox"/> DMX-512 <input type="checkbox"/> DMX-RDM <input type="checkbox"/> DALI <input type="checkbox"/> LUTH ?	<input type="checkbox"/> 120 <input type="checkbox"/> 277 <input type="checkbox"/> MVOLT	<input type="checkbox"/> WH-WHITE <input type="checkbox"/> BK-BLACK <input type="checkbox"/> BZ-BRONZE <input type="checkbox"/> SI-SILVER <input type="checkbox"/> Custom Color	<input type="checkbox"/> CM-CEILING MOUNT <input type="checkbox"/> WM-WALL MOUNT <input type="checkbox"/> PM12-12" <input type="checkbox"/> PM18-18" <input type="checkbox"/> PM24-24" <input type="checkbox"/> PM36-36" <input type="checkbox"/> PM48-48" <input type="checkbox"/> SM-10' SUSPENDED MOUNT (Consult factory for other sizes)	<input type="checkbox"/> EMG-LED-10W <input type="checkbox"/> EMG-LED-20W Typical lumen output of the luminaire is up to 1000L with EMG-LED-10W option & 2000L with EMG-LED-20W option in emergency mode. Contact the factory for details. Remote mounted installation	<input type="checkbox"/> HH10-1501 Flanged Downlight <input type="checkbox"/> HH10-1507 Flanged Wall Wash <input type="checkbox"/> HH10-1577 Flanged Double Wall Wash	<input type="checkbox"/> CL-WH <input type="checkbox"/> CL-SCH <input type="checkbox"/> SHZ-WH <input type="checkbox"/> SHZ-SHZ <input type="checkbox"/> WT-WH <input type="checkbox"/> W-WH <input type="checkbox"/> MB-WH <input type="checkbox"/> CL-BK <input type="checkbox"/> MB-BK	<input type="checkbox"/> EC-WC-TWH-HW-MVOLT <sup>1</sup>																
SCH10-LED-TWH-LENGN-65K-18K	<input type="checkbox"/> 1100L <input type="checkbox"/> 2000L	<input type="checkbox"/> DIM10 <input type="checkbox"/> DMX-512 <input type="checkbox"/> DMX-RDM <input type="checkbox"/> DALI <input type="checkbox"/> BLE **	<table border="1"> <tr> <th>OPTICS</th> <th>CRI</th> </tr> <tr> <td><input type="checkbox"/> VWD 70°</td> <td><input type="checkbox"/> 90+</td> </tr> <tr> <td><input type="checkbox"/> WD 60°</td> <td></td> </tr> <tr> <td><input type="checkbox"/> MWD 52°</td> <td></td> </tr> <tr> <td><input type="checkbox"/> MD 36°</td> <td></td> </tr> <tr> <td><input type="checkbox"/> ND 30°</td> <td></td> </tr> <tr> <td><input type="checkbox"/> SPD 24°</td> <td></td> </tr> <tr> <td><input type="checkbox"/> NSPD 15°</td> <td></td> </tr> </table>	OPTICS	CRI	<input type="checkbox"/> VWD 70°	<input type="checkbox"/> 90+	<input type="checkbox"/> WD 60°		<input type="checkbox"/> MWD 52°		<input type="checkbox"/> MD 36°		<input type="checkbox"/> ND 30°		<input type="checkbox"/> SPD 24°		<input type="checkbox"/> NSPD 15°							
OPTICS	CRI																								
<input type="checkbox"/> VWD 70°	<input type="checkbox"/> 90+																								
<input type="checkbox"/> WD 60°																									
<input type="checkbox"/> MWD 52°																									
<input type="checkbox"/> MD 36°																									
<input type="checkbox"/> ND 30°																									
<input type="checkbox"/> SPD 24°																									
<input type="checkbox"/> NSPD 15°																									

\* For 0-10V driver you must dedicate two control inputs, one for the Dimming Control and another for CCT Tuning.

\*\* Consult Factory

<sup>1</sup> Compatible with Elite 0-10V Platform and LED Engin 0-10V Platform. <sup>2</sup> (Lutron T Series 2 Channel Tunable White)



**SCH10-LED-TWH-50K-27K-2000L-ND-HH10-1501-CL-WH**

INPUT WATTS: **24.8** LUMENS: **2093** CRI: **90+** EFFICACY: **84** CCT: **4000K** SPACING CRITERIA: **0.44**

**Candle Power Distribution (Candelas)**

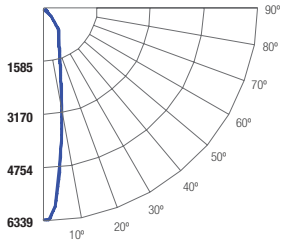

Cone of Light		
4.0	396	1.5 ft.
8.0	99.1	3.1 ft.
12.0	44.0	4.6 ft.
16.0	24.8	6.1 ft.
20.0	15.8	7.6 ft.
24.0	11.0	9.2 ft.
Distance to Plane	Initial Footcandle at Nadir	Beam diameter

BEAM DIA. MEASURED AT 50% OF NADIR F.C.

**Zonal Lumens Summary**

Zone	Lumens	%Lamp	%Fixt
0-20	995.74	47.60	47.60
0-30	1502.05	71.80	71.80
0-40	1919.71	91.70	91.70
0-60	2085.57	99.60	99.60
0-80	2092.54	100.00	100.00
0-90	2093.37	100.00	100.00

**Luminance (Average candela/M<sup>2</sup>)**

Angle in Degrees	Average		
	0°	45°	90°
45	3230	7321	11944
55	763	1252	2041
65	173	219	1029
75	106	177	232
85	69	433	537

**Lumens Per Zone**

Zone	Lumens
0-10	412.84
10-20	582.89
20-30	506.31
30-40	417.66
40-50	142.87
50-60	22.99
60-70	5.65
70-80	1.33
80-90	0.83

**Candela Tabulation**

Q	
0	6339.33
5	5150.18
15	1962.79
25	1044.09
35	752.22
45	72.67
55	13.92
65	2.32
75	0.87
85	0.19
90	0.05

**Coefficients of Utilization - Zonal Cavity Method**

Effective Floor Cavity Reflectance 0.20



RC	80%				70%				50%				30%				10%				0%			
	RW	70%	50%	30%	10%	70%	50%	30%	10%	50%	30%	10%	50%	30%	10%	50%	30%	10%	50%	30%	10%	0%		
0	119	119	119	119	116	116	116	116	111	111	111	106	106	106	102	102	102	100	100	100	100	94		
1	114	111	109	107	111	109	107	105	105	103	102	101	100	99	98	97	96	94	94	94	94	88		
2	109	104	100	97	106	102	99	96	99	96	94	96	94	92	93	92	90	88	88	88	88	82		
3	104	97	93	89	102	96	92	88	94	90	87	91	88	86	89	86	84	83	83	83	83	78		
4	99	92	86	82	97	90	86	82	88	84	81	86	83	80	85	82	79	78	78	78	78	73		
5	94	86	81	77	93	85	80	76	84	79	76	82	78	75	81	77	75	73	73	73	73	69		
6	90	82	76	72	88	81	76	72	79	75	71	78	74	71	77	73	70	69	69	69	69	65		
7	86	77	72	68	85	77	71	68	75	71	67	74	70	67	73	69	66	65	65	65	65	61		
8	82	73	68	64	81	73	68	64	72	67	64	71	66	63	70	66	63	62	62	62	62	59		
9	79	70	64	61	78	69	64	61	68	64	60	68	63	60	67	63	60	59	59	59	59	56		
10	76	67	61	58	75	66	61	58	65	61	57	65	60	57	64	60	57	56	56	56	56	52		

RC - Ceiling Cavity Reflectance RW - Wall Reflectance

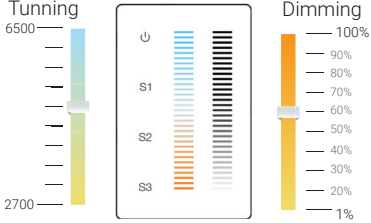

**CONTROL OPTIONS**

With the integration of controls, Elite Lighting now offers its products with controls-ready performance that increases energy efficiency, smarter space planning, and the enhancement of safety and productivity in the workplace. By utilizing these controls, Elite Lighting luminaires enable your customer's facility to run smarter, with the use of an easily controlled system through any platform.

CONTROL PROTOCOLS		SMART WHITE	LEDENGIN
<p><input type="checkbox"/> <b>ELITE-CONNECT</b> (EC-WC-TWH-HW-MVOLT) - Hard-wired, 0-10V, 120/277V wall mounted controller for CCT Tuning and Intensity Dimming through Simple Touch screen pad, provided by Elite Lighting. Programmable for up to 3-scenes, with a dimming range down to 1%. Applicable for office spaces, hospitality, educational, healthcare, and retail merchandising.</p>		✓	✓
<p><input type="checkbox"/> <b>DIM10</b> (0-10V 1% Dimming Standard) In order to Control the Color Tuning and dimming option with 0-10V driver you must dedicate two control inputs, one for the Dimming Control and another for CCT Tuning. Can be dimmed and tuned with 2 wall box dimmers and compatible with most control systems and/or daylight harvesting systems.</p> <p><input type="checkbox"/> <b>DIM10-LUTRON</b> Compatible with Lutron GRAFIK Eye QS or GRAFIK Eye 3000 by using two GRX-TVI Lutron 0-10V Dimming interfaces; one to tune and another to control dimming. Also compatible with Lutron VIVE system by using two FCJS-010 PowPak or FCJS-ECO EcoSystem PowPak modules per fixture; one to tune and one to control dimming.</p>		✓	✓
<p><input type="checkbox"/> <b>DMX</b> (Available on Elite, LED Engin) - Compatible with Digital Multiplex Controller, Available with two options: DMX-512: Standard DMX Controller and DMX-RDM: DMX Controller with Remote Device Management.</p>		✓	✓
<p><input type="checkbox"/> <b>LUTEKO</b> Compatible with Lutron EcoSystem. Compatible with Lutron GRAFIK Eye EcoSystem, Lutron Energi Saver node EcoSystem, or Lutron Quantum systems.</p>		✓	N/A
<p><input type="checkbox"/> <b>BLE</b> - Dimming and CCT can be controlled via Bluetooth using an app, via Smartphones or tablets.</p>		N/A	✓
<p><input type="checkbox"/> <b>DALI</b> Compatible with Digital Addressable Lighting Interface, available with two options: DT6 and DT8.</p>		✓	✓



**TWH-50K-27K**

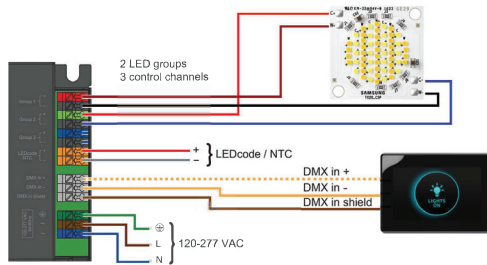
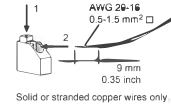
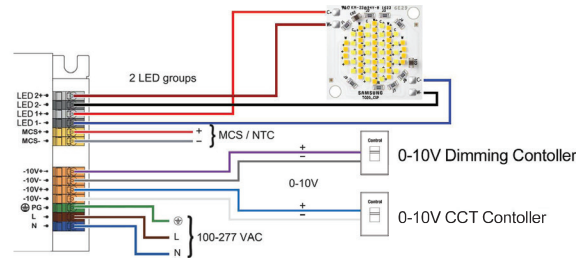

DMX512-A-RDM accessory board connects to an electrically isolated expansion port within the ALM

**TWH Controller EC-WC-TWH-HW-MVOLT**

Wiring Diagram:

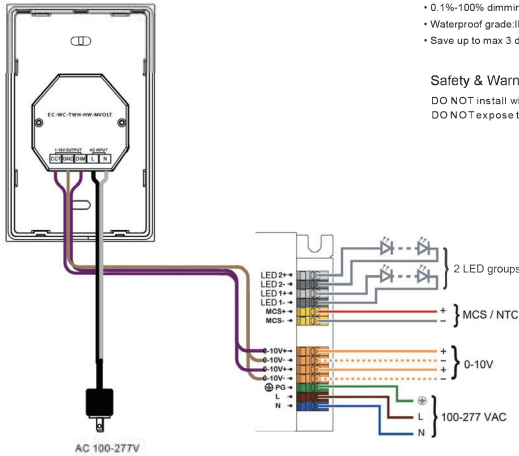

- 100-277VAC input.
- Touch slide tunable white and brightness control.
- 2 channels 1-10V signal output.
- 0.1%-100% dimming
- Waterproof grade IP20.
- Save up to max 3 different colors.

**Safety & Warnings:**  
DO NOT install with power applied to device.  
DO NOT expose the device to moisture.

Output Signal	2x(1-10V) signal
Power Supply	100-277VAC
Power consumption	30 mA max
Operating temperature	0-40°C
Relative humidity	8% to 80%
Dimensions	75x120x40.8mm

