

SCV6PL

6" ARCHITECTURAL CFL VERTICAL CYLINDER DOWNLIGHT

NEW



SCV6PL-CM

SCV6PL-WM

SCV6PL-PM

SCV6PL-SM

TRIM: 6101 REFLECTOR

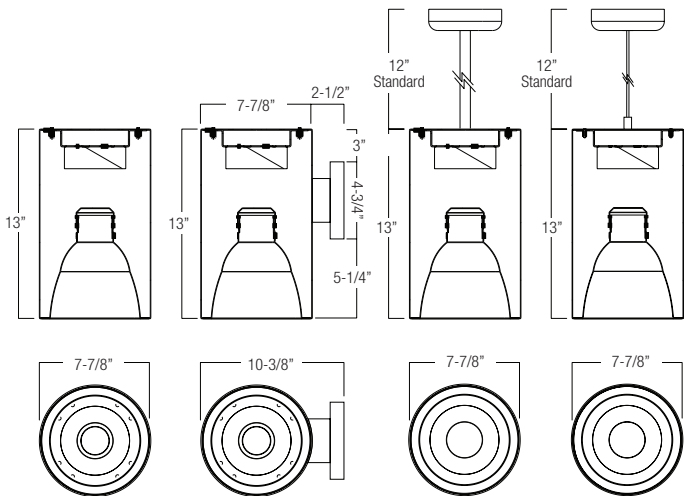

DESCRIPTION

LAMP HOLDER - Die-cast aluminum lamp holder effectively provides heat dissipation and ventilation. Unitized optics guarantees proper trim to housing installation. Tool-less installation adjustability from either outside the housing or inside the housing.

MOUNTING BRACKET - Ceiling mount bracket provided for direct installation with 3-1/4" to 4" octagonal and square junction box. Pendant mount option is available and supplied with 10-1/2" stem and 5" diameter canopy cover. Ideal for slope applications up to 45 degrees.

RETAINING SPRINGS - Precision tooled springs secure trim to mounting frame, for effortless and tool-less installation.

BALLAST - Ballast is accessible from below, no tools required. Ballast supplied is manufactured by Advance.

MOUNTING FRAME - Die formed steel housing with adjustable bracket allows optical adjustment of lamp. Unitized optics guarantees proper trim to housing tool-less installation.

OPTICS

REFLECTOR - Self-flanged .050" aluminum reflector with low iridescent finish. Reflector provides 45-degree lamp-to-reflector image cutoff.

GROOVE BAFFLE - Self-flanged one-piece aluminum with concentric rings.

LENS - Choice of either tempered clear, tempered prismatic or tempered frosted lens fastened with two torsion springs for easy re-lamping.

LISTING

UL listed for through-branch circuit wiring

Please visit our website for the most updated information on each product.



SCV6PL - ITEM SELECTOR: (Please check the boxes below for the option desired)

MOUNTING	BODY COLOR	WATTAGE	BALLAST	VOLTAGE	TRIM TYPE & DESCRIPTION	REFLECTOR	BAFFLE
<input type="checkbox"/> CM - Ceiling Mount	<input type="checkbox"/> WH - White	<input type="checkbox"/> 1X13	<input type="checkbox"/> (E) Electronic	<input type="checkbox"/> MVOLT (120/277)	<input type="checkbox"/> 6101 Reflector	<input type="checkbox"/> CL-WH	<input type="checkbox"/> W-CL-WH
<input type="checkbox"/> WM - Wall Mount	<input type="checkbox"/> BK - Black	<input type="checkbox"/> 1X18	<input type="checkbox"/> (S) Energy Star ¹	<input type="checkbox"/> 120	<input type="checkbox"/> 6102 Baffle/Reflector	<input type="checkbox"/> CL-SCH	<input type="checkbox"/> P-CL-WH
<input type="checkbox"/> PM12 - 12" Pendant Mount	<input type="checkbox"/> BZ - Bronze	<input type="checkbox"/> 1X26		<input type="checkbox"/> 277	<input type="checkbox"/> 6103 Ref./Fres. Gls. Lns.	<input type="checkbox"/> SHZ-SHZ	<input type="checkbox"/> W-WH
<input type="checkbox"/> PM18 - 18" Pendant Mount	<input type="checkbox"/> SI - Silver	<input type="checkbox"/> 1X32			<input type="checkbox"/> 6104 Ref./Pris. Gls. Lns.	<input type="checkbox"/> SHZ-WH	<input type="checkbox"/> P-WH
<input type="checkbox"/> PM24 - 24" Pendant Mount		<input type="checkbox"/> 1X42			<input type="checkbox"/> 6105 Baf./Fres. Gls. Lns.	<input type="checkbox"/> WT-WH	
<input type="checkbox"/> PM36 - 36" Pendant Mount					<input type="checkbox"/> 6106 Baf./Pris. Gls. Lns.	<input type="checkbox"/> W-WH	
<input type="checkbox"/> PM48 - 48" Pendant Mount					<input type="checkbox"/> 6107 Wall Wash Ref.	<input type="checkbox"/> W-WH	
<input type="checkbox"/> SM - 10' Suspended Mount <small>*For other sizes consult factory.</small>					<input type="checkbox"/> 6108 Crossblade Ref.	<input type="checkbox"/> MB-WH	
			DIMMING	EMERGENCY OPTION	<input type="checkbox"/> 6112 Baf./Frost Gls. Lns.		
			<input type="checkbox"/> Mark 7 ²	<input type="checkbox"/> EMG 750(750 lm) ⁷	<input type="checkbox"/> 6113 Baf./Tem. Clr. Gls.		
			<input type="checkbox"/> Mark 10 ³	OTHER OPTIONS	<input type="checkbox"/> 6114 Ref./Frost Gls. Lns.		
			<input type="checkbox"/> Lut-E (EC3D) ⁴	<input type="checkbox"/> FUSE ⁵	<input type="checkbox"/> 6115 Ref./Tem. Clr. Gls.		
				<input type="checkbox"/> RIF ⁶	<input type="checkbox"/> 6116 Ref./Pris. Plas. Lns.		
					<input type="checkbox"/> 6117 Baf./Pris. Plas. Lns.		
					<input type="checkbox"/> 6118 Ref./Tem. Clr. Plas.		
					<input type="checkbox"/> 6119 Baf./Tem. Clr. Plas.		

¹ - (S) Energy Star = Available on selected fixtures only, please see list above • ² - MARK 7 = Must specify voltage • ³ - MARK 10 = Not available on 13W, 57W, 70W, must specify voltage • ⁴ - LUT-E (EC3D) = Not available on 13W, 57W, 70W, must specify voltage • ⁵ - FUSE = Single slow-blow fuse • ⁶ - RIF = Radio interference filter • ⁷ - EMG = Emergency battery pack w/ remote test switch

The cylinder's bodies are available in WH - White, BK - Black, BZ - Bronze and SI - Silver.

Specifications:

SCV6PL

MOUNTING BODY COLOR WATTAGE BALLAST VOLTAGE OPTIONS TRIM TYPE REFLECTOR BAFFLE

Sample of Catalog Number: SCV6PL-CM-WH-1X26-E-MVOLT-6101-CL-WH

REFLECTOR	BAFFLE	RING
CL Clear	WH White	WH Self-Flange White
SHZ Satin Haze (Low Iridescent)	P Black	SCH Self-Flange Chrome
		SHZ Satin Haze
WT Wheat	*For custom baffle, reflector, trim ring, glass color and lens options, please consult factory.	
MB Black		
W White		

6101 -
Reflector



TRIM FINISH:

- CL-WH • WT-WH
- CL-SCH • W-WH
- SHZ-SHZ • MB-WH
- SHZ-WH

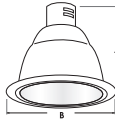

A= 7-1/8"
B= 7-3/8"

6102 -
Baffle with Reflector



TRIM FINISH:

- W-CL-WH
- P-CL-WH

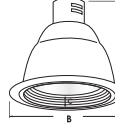

A= 7-1/8"
B= 7-3/8"
C= 1"

6107 -
Wall Wash Reflector



TRIM FINISH:

- CL-WH • WT-WH
- CL-SCH • W-WH
- SHZ-SHZ • MB-WH
- SHZ-WH

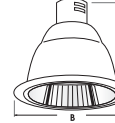

A= 7-1/8"
B= 7-3/8"

6108 -
Crossblade Reflector



TRIM FINISH:

- CL-WH • WT-WH
- CL-SCH • W-WH
- SHZ-SHZ • MB-WH
- SHZ-WH

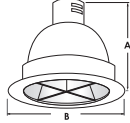

A= 7-1/2"
B= 7-3/8"

6103 -
Reflector with Fresnel Glass Lens



TRIM FINISH:

- CL-WH • WT-WH
- CL-SCH • W-WH
- SHZ-SHZ • MB-WH
- SHZ-WH

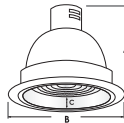

A= 7-1/2"
B= 7-3/8"
C= 1"

6104 -
Reflector with Prismatic Glass Lens



TRIM FINISH:

- CL-WH • WT-WH
- CL-SCH • W-WH
- SHZ-SHZ • MB-WH
- SHZ-WH

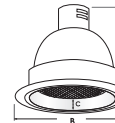

A= 7-1/2"
B= 7-3/8"
C= 1"

6114 -
Reflector with Frosted Glass Lens



TRIM FINISH:

- CL-WH • WT-WH
- CL-SCH • W-WH
- SHZ-SHZ • MB-WH
- SHZ-WH

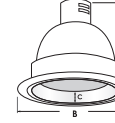

A= 7-1/2"
B= 7-3/8"
C= 1"

6115 -
Reflector with Tempered Clear Glass



TRIM FINISH:

- CL-WH • WT-WH
- CL-SCH • W-WH
- SHZ-SHZ • MB-WH
- SHZ-WH

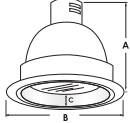

A= 7-1/2"
B= 7-3/8"
C= 1"

6105 -
Baffle with Fresnel Glass Lens

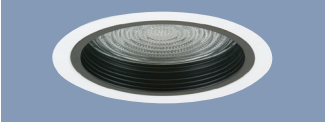

TRIM FINISH:

- W-WH
- P-WH

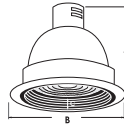

A= 7-1/2"
B= 7-3/8"
C= 1"

6106 -
Baffle with Prismatic Glass Lens

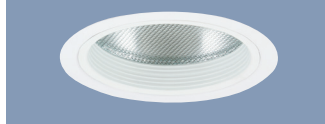

TRIM FINISH:

- W-WH
- P-WH

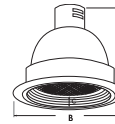

A= 7-1/2"
B= 7-3/8"
C= 1"

6112 -
Baffle with Frosted Glass Lens



TRIM FINISH:

- W-WH
- P-WH

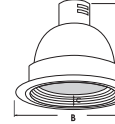

A= 7-1/2"
B= 7-3/8"
C= 1"

6113 -
Baffle with Tempered Clear Glass



TRIM FINISH:

- W-WH
- P-WH

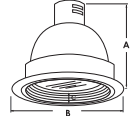

A= 7-1/2"
B= 7-3/8"
C= 1"

6116 -
Reflector with Prismatic Plastic Lens



TRIM FINISH:

- CL-WH • WT-WH
- CL-SCH • W-WH
- SHZ-SHZ • MB-WH
- SHZ-WH

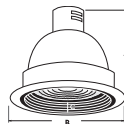

A= 7-1/2"
B= 7-3/8"
C= 1"

6117 -
Baffle with Prismatic Plastic Lens

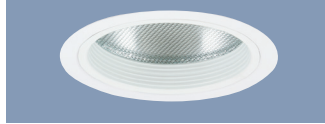

TRIM FINISH:

- W-WH
- P-WH

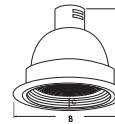

A= 7-1/2"
B= 7-3/8"
C= 1"

6118 -
Reflector with Tempered Clear Plastic



TRIM FINISH:

- CL-WH • WT-WH
- CL-SCH • W-WH
- SHZ-SHZ • MB-WH
- SHZ-WH



A= 7-1/2"
B= 7-3/8"
C= 1"

6119 -
Baffle with Tempered Clear Plastic



TRIM FINISH:

- W-WH
- P-WH

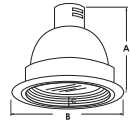

A= 7-1/2"
B= 7-3/8"
C= 1"

