

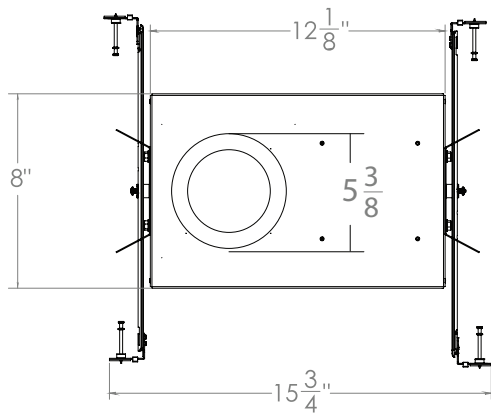

REFLECTOR/ TRIM COLOR

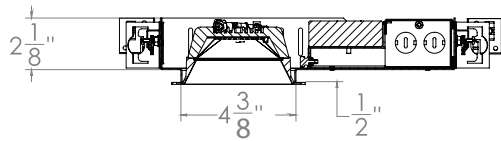

WH-WH-White



NOMINAL LUMENS	WATTAGE
1500	22.8W
1200	13.9W
900	10.2W

Based on 4000K, 90+ CRI. Actual wattage may vary +/- 5%

**FEATURES**

An innovative, high-performance shallow plenum architectural LED Round downlight for applications that demand a shallow housing, optimizing functionality. Available in a range of distributions and lumen packages, it is the perfect solution for commercial elevator lobbies, hospitality, high-end residential, and retail applications.

LUMENS	900, 1200, 1500
CCT & DYNAMIC PLATFORMS	100% lumen output at 3000K, down to 1% lumen output at 1800K
CRI	90+ Standard
COLOR QUALITY	2 Step MacAdam Ellipses
DISTRIBUTION	NSPD(Narrow Spot-15°), SPD(Spot-24°), MD(Medium-36°) WD(Wide-60°), VWD( Very Wide-60°)
TRIM OPTIONS	Square and Round, Trim and Trimless Downlighting
REFLECTOR COLORS	WH (White), Custom RAL
FLANGE COLORS	WH (White), Custom RAL
DIMMING	0-10V Flicker Free 1% Dimming Standard (DIM10), LUTH, LUT2W, ELDO10.1, ELDDMX.1, DALI.1, DIMTR
EMERGENCY	10W - Bodine BSL310 20W - Bodine BSL20
LIFETIME	102,000 Hours
PHOTOMETRIC TESTS	In Accordance with IES LM79-08, LM80 and TM-30, TM-21

VWD: VERY WIDE  
Candlepower Distribution Curve

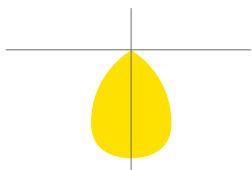

WD: WIDE  
Candlepower Distribution Curve

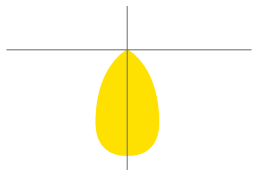

MD: MEDIUM  
Candlepower Distribution Curve

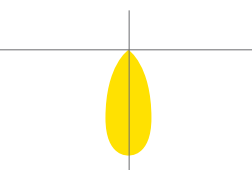

SPD: SPOT  
Candlepower Distribution Curve

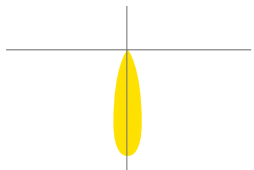

NSPD: NARROW SPOT  
Candlepower Distribution Curve

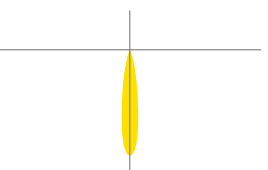

Reference IES files for additional distribution curve information.





**DYNAMIC PLATFORM**



SMART DIM - Dims to Warm with Smart Dim technology simulates traditional incandescent halogen lighting through dimming, while providing the energy efficiency, high performance and longevity of LED luminaires. When the luminaire dims to warm, it makes a smooth transition across the black body radiator curve. Starting with a 100% lumen output at 3000K, down to a 1% lumen output at 1800K, and maintaining a constant CRI of 90+. It results in rich amber tones as the light dims, encouraging relaxation. An ideal source for hospitality, residential, and assisted living applications.

**TRIM OPTION**

Round Trim and Trimless

**HOUSING**

Thermally protected, specification grade recessed housing. For new construction non insulated or insulated ceilings where housing will be in direct contact with insulation. Die-formed all aluminum construction matt black painted for maximum heat dissipation, rust protection and glare free illumination.

**MOUNTING**

Preinstalled bar hangers allow housing to be positioned and locked at any point within a 24" joist span. Bar hangers can fit onto T-Bar spline with additional slots and holes for special mounting methods if necessary. Butterfly brackets are also provided and are constructed from 18-gauge steel and can be adjusted vertically. Butterfly brackets may be installed with 3/4" or 1-1/2" lathing channel, 1/2" EMT, or optional C-Channel mounting bars are available.

**DRIVER ELECTRICAL INFORMATION**

The LED driver is rated for 50 to 60Hz at 120V/277V also available in 347V input, produces less than 20%THD, and has a power factor between 90% and 100%, and is thermally protected for additional safety. Junction box and Driver can be accessed from below the ceiling and above the ceiling. Junction Box is Listed for through branch circuit wiring.

**OPTICS**

Modular Optics Available with 15°, 24, 36°, 60° and 70° field interchangeable optics design with 50° cutoff to source. Top-down flash characteristic for superior glare control. The optics attached directly the light engine to the Trim for complete optical alignment and sufficient efficacy.

**DIMMING & DRIVER INFORMATION**

**DIM10** - 0-10V dimming on either MVOLT 120, 277 or 347V. Dimmable down to 1% of initial lumens, standard.

**DIMTR** - Triac & Electronic low voltage dimming. Available in 120V, and up to 3000 lumens only.

**LUT2W** - Lutron LTEA2W Hi-Lume 1%. 2-wire LED driver (120V forward phase only).

**LUTH** - Lutron LDE1 Hi-Lume 1% EcoSystem LED driver with Soft-on, Fade-to-Black dimming technology.

**ELDO10.1** - EldoLED SoloDrive 0-10V. Dimming down to 0.1%. Available on all fixtures up to 100 watts.

**DALI** - DALI DT6, DT8 dimming down to 1%. Available on all fixtures up to 100 watts.

**ELDOMX** - EldoLED PowerDrive dimming down to 0.1%. Available on all fixtures up to 100 watts.

Please see EldoLED website for wiring diagrams and a list of compatible DMX and Dali control systems.

**WARRANTY**

Five-year carefree warranty for parts and components. (Labor not included.)

**LISTINGS**

c-UL-us - Listed for Feed Through Wiring.

All LED luminaires are rated and tested to LM-79 and LM-80 standards by an independent laboratory.

**HOUSING**

	TYPE	LUMEN	DIMMING	VOLTAGE	EMERGENCY OPTIONS	MOUNTING OPTIONS
HIGH PERFORMANCE	SR4-LED-IC	<input type="checkbox"/> 900L* <input type="checkbox"/> 1200L <input type="checkbox"/> 1500L	<input type="checkbox"/> DIM10 <input type="checkbox"/> DIMTR <input type="checkbox"/> LUTTH <input type="checkbox"/> LUT2W <input type="checkbox"/> ELDO10.1 <input type="checkbox"/> DALI1 <input type="checkbox"/> ELDODMX.1	<input type="checkbox"/> 120 <input type="checkbox"/> 277 <input type="checkbox"/> 347 (DIM10 only) <input type="checkbox"/> MVOLT	<input type="checkbox"/> EMG-LED-10W <input type="checkbox"/> EMG-LED-20W	<input type="checkbox"/> Blank-Standard bar hangers (included) <input type="checkbox"/> BP31 - 27" C-channel bar hangers. <input type="checkbox"/> RIF - RIF filter.

DIMTR, LUT2W - 120V only  
LUTH, ELDO10, DALI, ELDODMX - 120-277V

**TRIM OPTIONS**

TRIM TYPE	LUMENS	OPTICS	CCT	FINISH
<input type="checkbox"/> SR4-F-1428 ( Flanged trim)	<input type="checkbox"/> 900L* <input type="checkbox"/> 1200L <input type="checkbox"/> 1500L	<input type="checkbox"/> NSPD <input type="checkbox"/> SPD <input type="checkbox"/> MD <input type="checkbox"/> WD <input type="checkbox"/> VWD	<input type="checkbox"/> WDM (30K-18K) (3000K at 100% Light out put and 1800K at 1% Light Output)	<input type="checkbox"/> W-WH
<input type="checkbox"/> SR4-TL-1428 ( Trim-less)	<input type="checkbox"/> 900L* <input type="checkbox"/> 1200L <input type="checkbox"/> 1500L	<input type="checkbox"/> NSPD <input type="checkbox"/> SPD <input type="checkbox"/> MD <input type="checkbox"/> WD <input type="checkbox"/> VWD	<input type="checkbox"/> WDM (30K-18K) (3000K at 100% Light out put and 1800K at 1% Light Output)	<input type="checkbox"/> WH

\* TRIM OPTION FOR IC HOUSING IS ONLY AVAILABLE ON 900L