

EL2HALEDEM

Remote Capable Dual Adjustable LED Emergency Light with Battery Back-Up

Specifications/Features

Fixture

Injection molded thermoplastic ABS housing.
 UL 94V-0 Flame rating.
 Innovative, snap-together design allows for fast and easy installation.
 Two fully adjustable, glare free, rectangular shaped lamp heads.
 Compact design.

Mounting

Wall or ceiling mount.
 Easily removeable mounting knock-outs and J-box pattern on back panel.

Electrical

120/277VAC dual voltage operation.
 Push button test switch and charge light indicator.
 LED emergency heads each deliver 93 lumens at 2.5W each.
 Lead-Calcium battery (6V, 4.5Ah) delivers more than 90 minutes capacity to emergency heads.
 Can be used to energize four (4) REL1L remote single heads units or two (2) REL2L remote dual head units.
 Maximum distance REL1L remote single heads can be from unit is 65 feet; maximum distance REL2L remote dual heads can be from unit is 42 feet.
 24 hour recharge after 90 minute discharge.
 Low voltage battery disconnection prevents deep discharge damage to the battery.

Warranty

This fixture is covered by ConTech's full one (1) year replacement guarantee after date of purchase.

Listing

UL listed for damp location. Meets UL924.

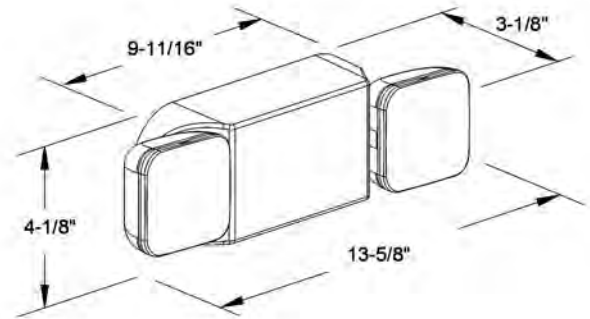

Lamp Heads: 3-3/8" x 3-3/16"

Ordering Information

Example Order: -

Fixture

EL2HALEDEM

Finish

B - Black
P - White

EL2HALEDEM

Remote Capable Dual Adjustable
LED Emergency Light with Battery Back-Up

Photometrics

EL2HALEDEM

Designed for 25,000 Hour Lamp Life¹; LM-63 Test No. 82676

Light Output (Fixture Delivered Lumens): 92.6
Total Watts@120V: 2.18; Lumens Per Watt: 42.5
Center Beam Candle Power: 80.7
Color Rendering Index (CRI)²: 72
Color Temperature (CCT)³: 4405K
Spectral Power Distribution Chart⁴

LM-79 Test No. 82677

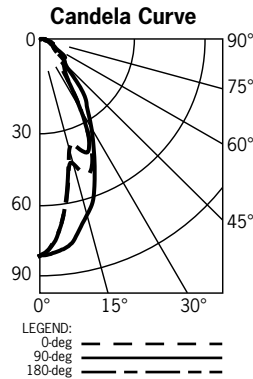
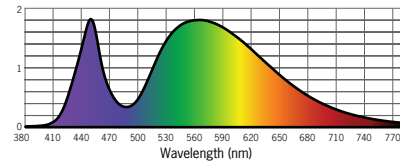

Candlepower Summary

FROM 0	CANDELA	LUMENS
0	80.7	
5	73.6	7.0
15	47.8	15.5
25	46.0	19.2
35	18.8	15.4
45	12.4	10.6
55	7.2	7.9
65	5.5	5.9
75	3.6	4.4
85	2.1	2.9
95	1.4	1.8

Intensity Distribution

DISTANCE (FT.)	FOOTCANDLES (FC)	BEAM DIAMETER (FT.)
4'	5.0	4.5
6'	2.2	6.7
8'	1.3	8.9
10'	0.8	11.2
12'	0.6	13.4
14'	0.4	15.6

Beam Distribution: 58°

EL2HALEDEM SINGLE COVERAGE

5W Total White LEDs

Using a single unit at a typical 7.5' mounting height, delivers an average illuminance of 1.0FC over as distance of 12' on a 3' path of egress and 8' on a 6' path of egress.

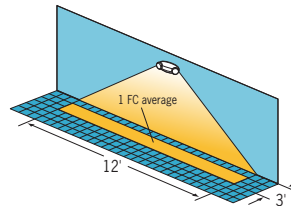

Mounting Height: 7.5'
Tilt Angle: 30° from NADIR
Orientation Angle: 210° and 330°

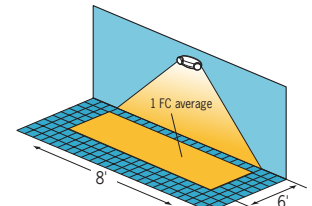

Mounting Height: 7.5'
Tilt Angle: 33° from NADIR
Orientation Angle: 235° and 305°

EL2HALEDEM MULTIPLE COVERAGE

5W Total White LEDs

Using multiple units at a typical 7.5' mounting height, delivers 17' center-to-center spacing on a 3' path of egress, and 15' center-to-center on a 6' path of egress.

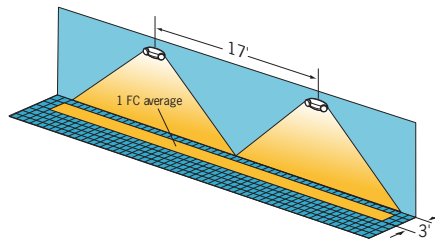

Mounting Height: 7.5'
Tilt Angle: 30° from NADIR
Orientation Angle: 200° and 340°

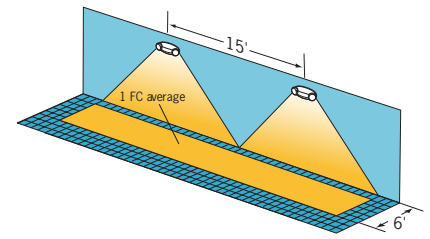

Mounting Height: 7.5'
Tilt Angle: 33° from NADIR
Orientation Angle: 225° and 315°