

### Spec Guide

## BoxRail® | Surface Mount | 907

Accent, ambient or task lighting for wall or ceiling wash, grazing, cove or reveal accent.



BoxRail: Button Board

### Benefits & Features

#### Minimal, Robust Design

Square profile, 1.14" (29mm) x 1.14" (29mm).

#### Superior Light Quality & Performance

Output up to 1367 lm/ft (4485lm/m) (HO), 120 lm/W (SO). 80 or 90 CRI & tunable white (2200K-6500K) available.

#### Adaptive Mounting System

Full range dimming power for all protocols.

#### Better Optics & Beam Control Options

Options of 36°, 19° x 48°, MicroBaffle™, optical film and diffuse lens. Directional control with rotation, angle gauge and lock.



85° Black Asymmetric



Rotating Bracket

## Build Your Specification

<b>907-BX</b>				»»
<b>System &amp; Rail Type</b>	<b>System Length</b>	<b>Rail Length</b>	<b>Mounting</b>	<b>Power Location</b>
907-BX BoxRail	Specify overall system length in ft/in or M/mm.	<b>24</b> 24" (610mm) <b>36</b> 36" (914mm) <b>48</b> 48" (1219mm) <b>60</b> 60" (1524mm) <b>72</b> 72" (1829mm) <b>ZZ</b> Other rail length or layout (please specify)	<b>F1S</b> Fixed 1 <b>R1B</b> Rotate 1 <b>R2S</b> Rotate 2	<b>Remote Power</b> <b>RP10</b> 10' (3.048m) Wire Harness <b>RP25</b> 25' (7.62m) Wire Harness <b>RP50</b> 50' (15.24m) Wire Harness <b>RP75</b> 75' (22.86m) Wire Harness <b>RP100</b> 100' (30.48m) Wire Harness
See <a href="#">Rail Length Chart</a> for more details				

»»				»»
<b>Power Type</b>	<b>Voltage</b>	<b>Emergency Power</b>	<b>LED Type</b>	<b>Lumen Output</b>
<b>Flexible 1 to 1 Power</b> <b>AE</b> eldoLED 0-10V, 1.0% Dimming <b>AT</b> eldoLED 0-10V, 0.1% Dimming <b>AD</b> eldoLED DALI, 0.1% Dimming <b>AX</b> eldoLED DMX, 100-0% Dimming <b>AH</b> Hi-lume 1% EcoSystem, Soft On / Fade to Black Technology, LDE1 <b>AH2</b> Hi-lume 1% 2-wire LTEA2W (120V forward phase only)	<b>1</b> 120V <b>2</b> 120V - 277V <b>X</b> Not Yet Specified	<b>0</b> No Emergency Power <b>ZZ</b> Emergency Power (specify requirements)	<b>Z</b> Zipper Board <b>B</b> Button Board <sup>3</sup>	<b>LO</b> Low Output <b>SO</b> Standard Output <b>HO</b> High Output <b>ZZ</b> Other (please specify)
<b>Optimized Power</b> Add 'O' to power type example: AEO, ATO...etc. <sup>1</sup> <b>VodeNODE</b> Add 'N' to power type for Flexible 1 to 1 Power Add 'ON' to power type for Optimized Power example: AEN, ATN, AEON, ADON...etc. <sup>2</sup> <b>ZZ</b> Other (please specify)				See <a href="#">IES Files</a> page for details. See <a href="#">Power Guide</a> for driver features & limitations.
See <a href="#">Power Guide</a> for driver features & limitations.				

»»				»»
<b>Color Temperature</b>	<b>Optics</b>	<b>Sensors</b>	<b>Finish</b>	<b>Options</b>
<b>80+ CRI</b> <b>27</b> 2700K <b>30</b> 3000K <b>35</b> 3500K <b>40</b> 4000K <b>90+ CRI</b> <b>279</b> 2700K <b>309</b> 3000K <b>359</b> 3500K <b>409</b> 4000K <b>ZZ</b> Tunable White Available <a href="#">See Guide</a> for details	<b>Zipper Board (Z)</b> <b>1</b> Diffuse <b>WB</b> White Baffle <b>BB</b> Black Baffle <b>G1</b> 120° Batwing <b>G2</b> 120° FlyWing <b>S1</b> 40° Symmetric <b>S2</b> 60° Symmetric <b>A1</b> 85° Asymmetric  <b>Button Board (B)</b> <b>19</b> 19° x 48° Oval <b>36</b> 36° Medium	<b>0</b> None <b>ZZ</b> Sensor (specify requirements)	<b>AL</b> Clear Anodized <b>WH</b> White Painted <b>BL</b> Black Anodized <b>ZZ</b> Other (please specify)	<b>0</b> None <b>ZZ</b> Other (please specify)

**NOTES & LIMITATIONS**

- <sup>1</sup> Optimized Power is not available with Lutron Hi-lume 1% EcoSystem (AHO) Power Type.
- <sup>2</sup> VodeNODE enclosure is not available with Hi-lume 1% 2-wire (AH2) Power Type.
- <sup>3</sup> Button Board (B) is not available in 90 CRI.  
Contact factory for Chicago Plenum.

Standard 5 Year Limited Warranty. See details [here](#). Contact factory for options on Limited Warranties up to 20 years.

Listed to UL standards for damp location by a Nationally Recognized Testing Laboratory (NRTL) recognized by OSHA. Certain limitations exist for each Certification. Contact factory for verification.



# Applications

## General Interior and Open Office



Wesley Mission, Sydney



Wesley Mission, Sydney

## Applications

### Cove

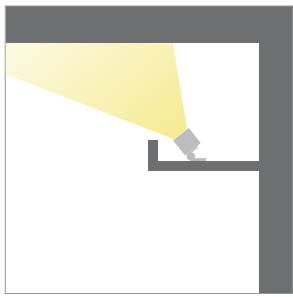

Ideal for office, retail, hospitality, museum and residential.

### Slot

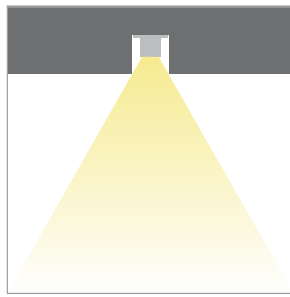

Ideal for office, institutional, retail and hospitality.



Ideal for lobby, retail, hospitality and institutional.

### Surface

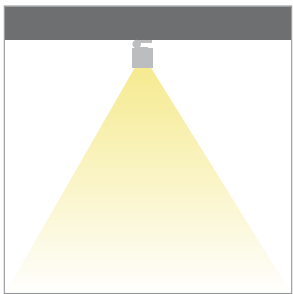

Ideal for retail, hospitality, museum and residential.

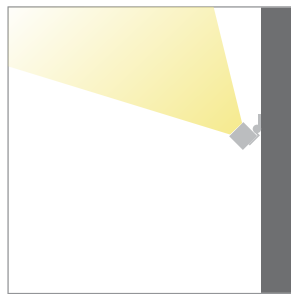

Ideal for retail, hospitality, museum and residential.

### Cove, Perimeter Slot, Wall Graze, and Flood

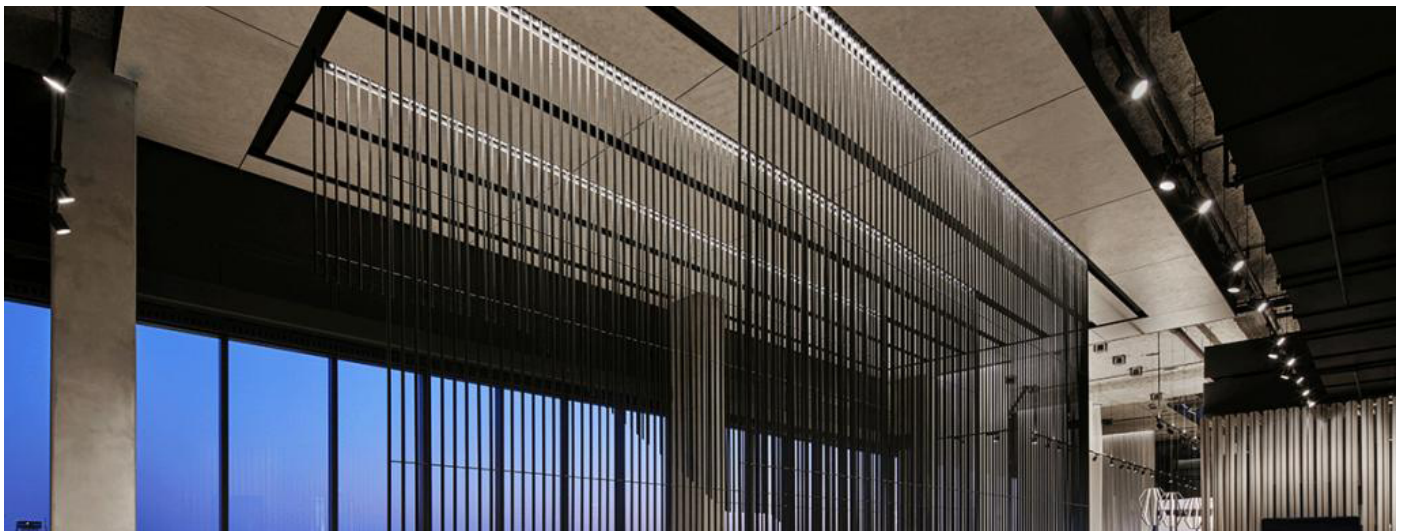

Corrs Chambers Westgarth, Melbourne, VIC

# Applications

## Cove, Perimeter Slot, Wall Graze, and Flood



The Fairmont, Washington, DC

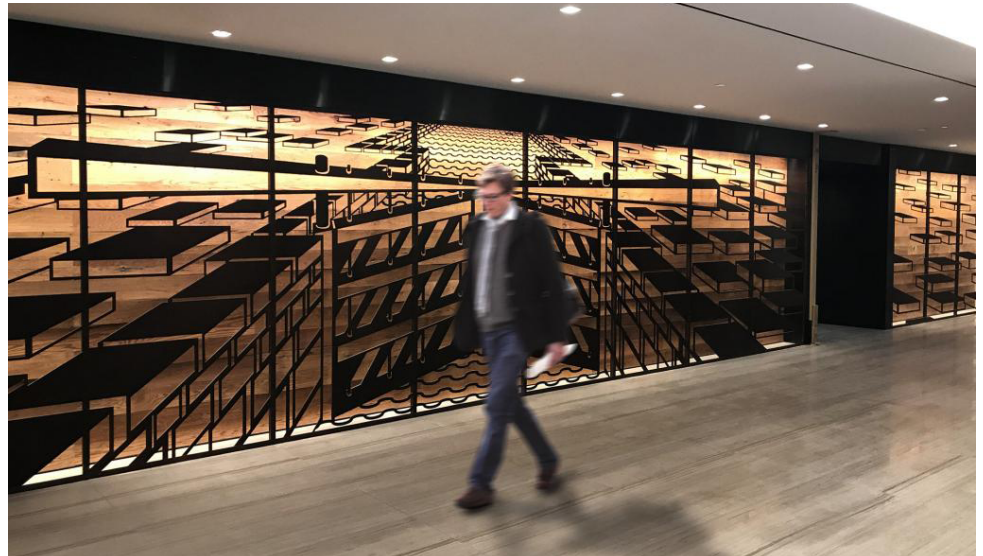

The Foundry, Washington, DC



Corrs Chambers Westgarth, Melbourne, VIC

## Structure

Rail Lengths	24" (610mm) - 72" (1828mm). Modified lengths available. See <a href="#">Rail Length Chart</a> for more details.
Rail Dimensions	1.14" (29mm) x 1.14" (29mm) x length.
Construction	Extruded and machined 6063 aluminum.
System Run Length	24" (610mm) minimum. Unlimited maximum.
Operating Temperature	32°F to 104°F (0°C to 40°C).
Humidity	0-85%, non-condensing.
Weight	0.65lbs per ft (0.29kg per 305mm). Power supply and housing not included.

## Materials

LED Board Construction	Aluminum core PCB, black LCP connectors, RoHS compliant.
Lens	High-impact extruded acrylic glass (PMMA).
Baffle	6063 aluminum, RoHS compliant painted finish.
Button Optics	High-impact cast acrylic glass (PMMA), polycarbonate (PC) holder.
Power Cable	Ø4mm, 18/2 AWG, Plenum (CMP) rated semi-rigid PVC or FEP, flame tested UL-910 ( <i>PVC free in 2020</i> )
Cable Connectors	Unfilled black nylon, rated UL 94 V-0, halogen free, PVC or FEP overmold, RoHS compliant ( <i>PVC free in 2020</i> )
Remote Linear Power Housing (RLP)	20.7" x 2.375" x 2.53", 0.054" formed Galvanized Steel
Remote Brick Power Housing (RBP)	4.32" x 3.37" x .078" Galvanized Steel mounting plate

## Dimensions

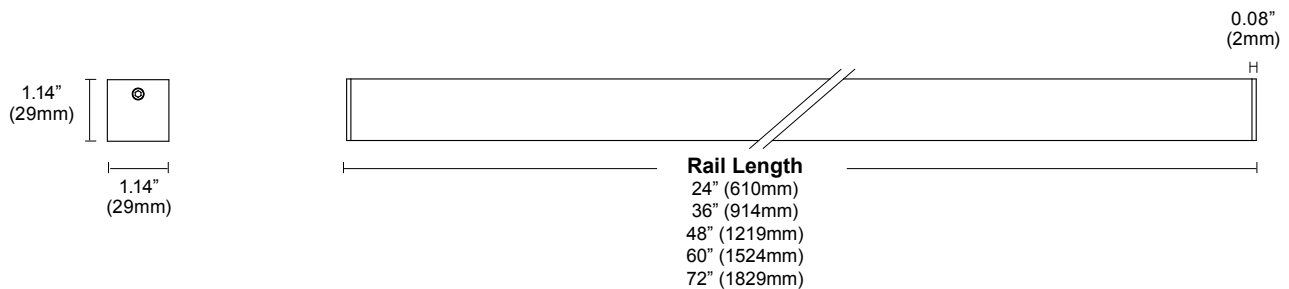

## Mounting Options

Fixed 1

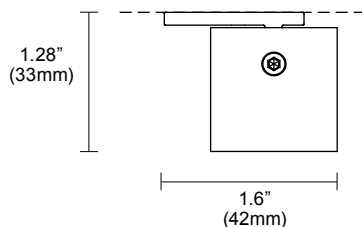

**Installation** 1.6" (42mm) is required for bracket installation.  
**Power Feed** Located on side, 3" (75mm) from one end of the fixture.

Rotate 1

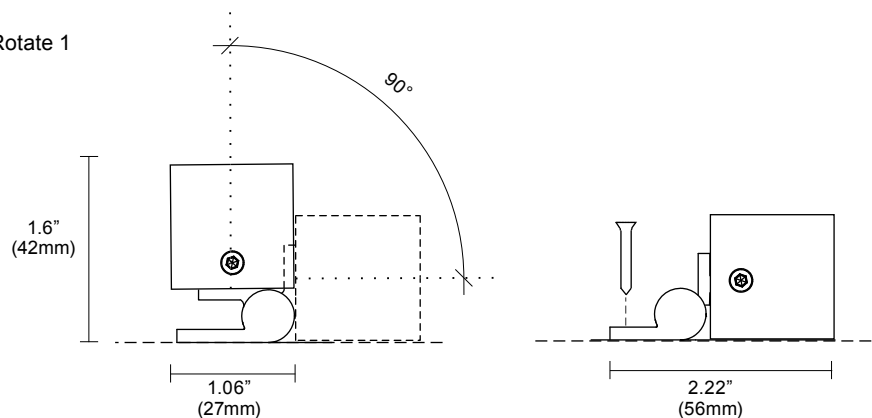

**Installation** Allow 2.5" (64mm) on the mounting surface for installation.  
**Power Feed** Located on bottom, 3" (75mm) from one end of the fixture.  
**Bracket Rotation** Rotates 90°. May be locked in any position.

## Mounting Options Continued

### Rotate 2

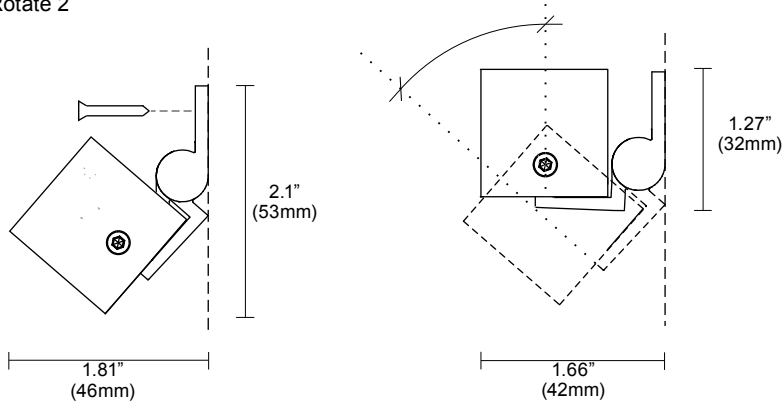

Installation	Allow 2.5" (64mm) on the mounting surface for installation.
Power Feed	Located on side, 3" (75mm) from one end of the fixture.
Bracket Rotation	Rotates 48°. <i>May be locked in any position.</i>

## Power and Controls

Power Type	Class 2 (<60V output) constant current driver
Dimming Controls	Dimming (0.1%, 1%), 0-10V, DALI, DMX, Lutron Hi-lume 1% are available. See <a href="#">Power Guide</a> for details.
Input Voltage	120V - 277V, 50/60hz
Power Location	Remote power. Maximum remote distance up to 100' (30.5m) <i>depending</i> on driver selection. See <a href="#">Power Guide</a> for details.

Remote power is locating the power supply away from the fixture. Remote power comes in two housing styles: brick style and linear style. Consult [Power Guide](#) to determine which type you will receive.

### Remote Brick Power Housing

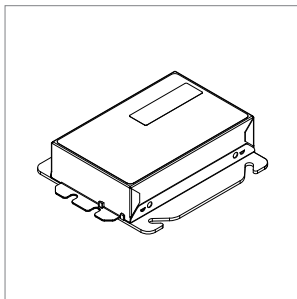

Supplied for some remote power applications. One remote power supply housing is supplied for each rail. Provided driver mounting plate fits standard 4" metal, square J-Boxes with a minimum volume of 21 in<sup>3</sup> (J-Box not provided). See [Tech Sheet](#) for details.

### Remote Linear Power Housing

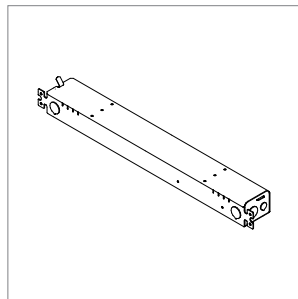

One remote power supply housing is supplied with each power supply. All Vode linear remote drivers come in a 0.054" (0.8mm) formed galvanized steel power supply housing with five (5) knockouts: (4) 1-1/8", (1) 7/8" and (1) 9/16". Accommodates standard linear power supplies. See [Tech Sheet](#) for details.

### Wire Harness

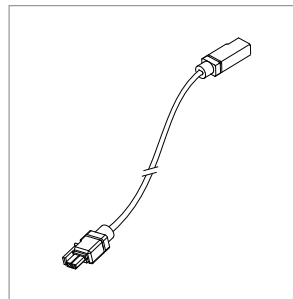

Wire harness connects driver to rail section. Lengths of 10' (3.0m) & 25' (7.6m) with snap-lock connectors for quick and easy installation. Multiple harnesses may be combined for lengths up to 100' (30.5m). See [Tech Sheet](#) for details.

## Power and Controls

### Flexible 1 to 1 power

For Flexible 1 to 1 Power, Vode supplies one single output driver per fixture, allowing each fixture to be controlled independently. Direct/Indirect fixtures are supplied with two single output drivers, allowing the direct and indirect lighting to be controlled independently. Consult [Power Guide](#) to determine which type you will receive.

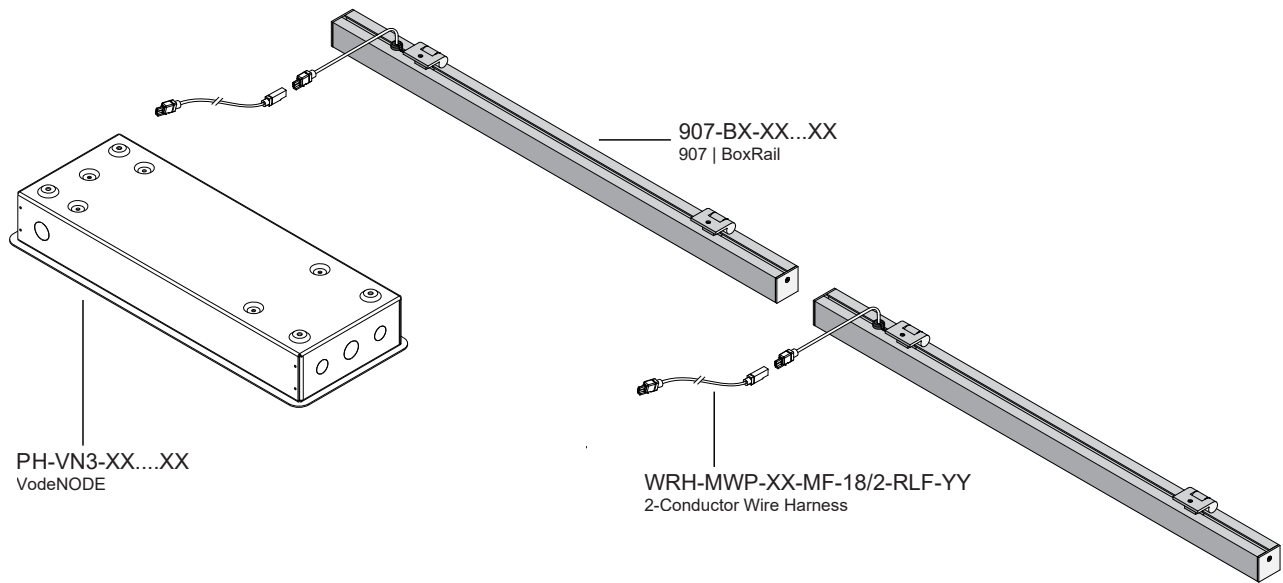

### Optimized Power

To optimize power, Vode configures specifications with drivers that have 2 or 4 outputs. Depending on system configurations and power requirements, up to 4 fixtures can be powered from a 4-output driver. Consult [Power Guide](#) to determine which type you will receive.

IMPORTANT: Each fixture will still require individual wire harnesses, as shown below.

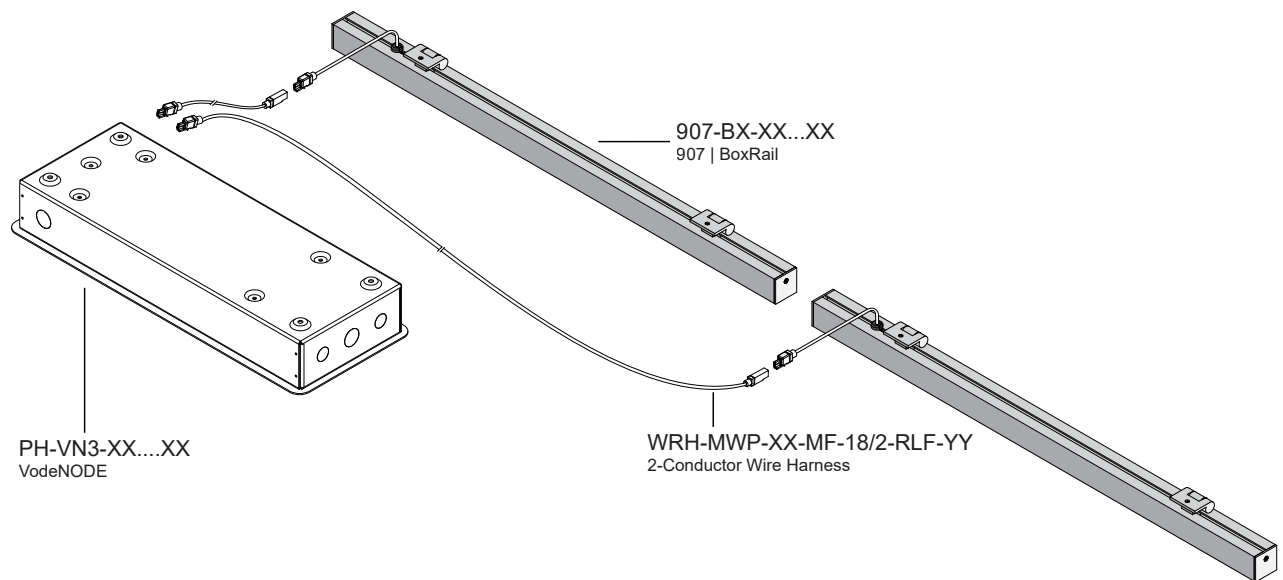

Note: Drawings not to scale, for reference only.



## Performance | Zipper Board Optics

Zipper Board Optics design has 72 diodes per foot (305mm).

### Diffuse (1)

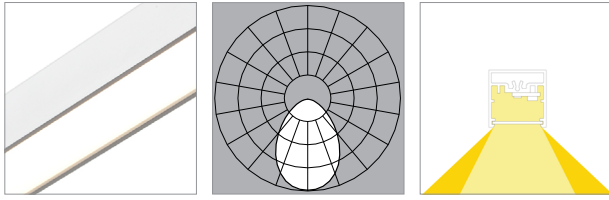

L80 >60,000 hours

	80 CRI (80min., 84 avg.)				90 CRI (90min., 96 avg.)			
	2700K	3000K	3500K	4000K	2700K	3000K	3500K	4000K
<b>Low Output (LO)</b>								
Efficacy - Lumens per Watt	76	79	79	79	66	68	69	71
Lumens per foot (305mm)	283	292	295	305	244	252	257	262
Watts per foot (305mm)	3.8	3.8	3.8	3.8	3.8	3.8	3.8	3.8

### Standard Output (SO)

Efficacy - Lumens per Watt	94	97	98	98	82	84	86	88
Lumens per foot (305mm)	566	584	589	589	489	504	515	525
Watts per foot (305mm)	6.1	6.1	6.1	6.1	6.1	6.1	6.1	6.1

### High Output (HO)

Efficacy - Lumens per Watt	88	91	92	92	76	78	80	82
Lumens per foot (305mm)	1075	1109	1120	1120	929	958	978	997
Watts per foot (305mm)	12.4	12.4	12.4	12.4	12.4	12.4	12.4	12.4

### White Baffle (WB)

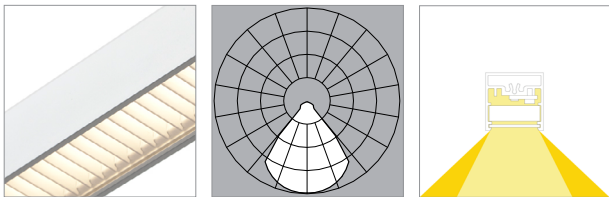

L80 >60,000 hours

	80 CRI (80min., 84 avg.)				90 CRI (90min., 96 avg.)			
	2700K	3000K	3500K	4000K	2700K	3000K	3500K	4000K
<b>Low Output (LO)</b>								
Efficacy - Lumens per Watt	52	54	54	55	44	47	47	48
Lumens per foot (305mm)	191	201	201	205	164	173	173	177
Watts per foot (305mm)	3.8	3.8	3.8	3.8	3.8	3.8	3.8	3.8

### Standard Output (SO)

Efficacy - Lumens per Watt	64	66	67	67	55	57	58	59
Lumens per foot (305mm)	381	393	401	401	329	339	346	353
Watts per foot (305mm)	6.1	6.1	6.1	6.1	6.1	6.1	6.1	6.1

### High Output (HO)

Efficacy - Lumens per Watt	59	61	62	64	51	53	54	55
Lumens per foot (305mm)	725	748	763	778	625	644	658	671
Watts per foot (305mm)	12.4	12.4	12.4	12.4	12.4	12.4	12.4	12.4

## Performance | Zipper Board Optics

Zipper Board Optics design has 72 diodes per foot (305mm).

### Black Baffle (BB)

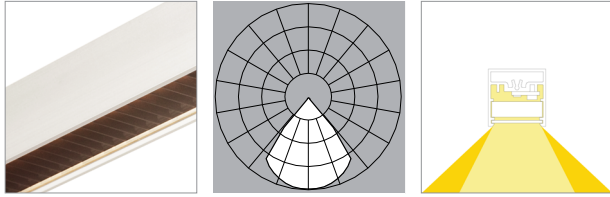

L80 >60,000 hours

	80 CRI (80min., 84 avg.)				90 CRI (90min., 96 avg.)			
	2700K	3000K	3500K	4000K	2700K	3000K	3500K	4000K
<b>Low Output (LO)</b>								
Efficacy - Lumens per Watt	28	30	30	31	25	26	26	26
Lumens per foot (305mm)	105	110	110	112	90	95	95	97
Watts per foot (305mm)	3.8	3.8	3.8	3.8	3.8	3.8	3.8	3.8

### Standard Output (SO)

Efficacy - Lumens per Watt	35	36	37	38	30	31	32	33
Lumens per foot (305mm)	209	216	220	225	180	186	190	194
Watts per foot (305mm)	6.1	6.1	6.1	6.1	6.1	6.1	6.1	6.1

### High Output (HO)

Efficacy - Lumens per Watt	33	34	35	35	28	29	30	30
Lumens per foot (305mm)	397	410	418	427	343	353	361	368
Watts per foot (305mm)	12.4	12.4	12.4	12.4	12.4	12.4	12.4	12.4

### 120° Batwing (G1)

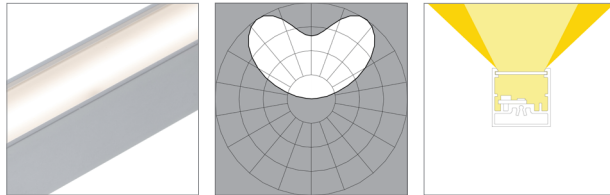

L80 >60,000 hours

	80 CRI (80min., 84 avg.)				90 CRI (90min., 96 avg.)			
	2700K	3000K	3500K	4000K	2700K	3000K	3500K	4000K
<b>Low Output (LO)</b>								
Efficacy - Lumens per Watt	98	101	103	105	84	87	89	91
Lumens per foot (305mm)	364	375	383	391	314	323	330	337
Watts per foot (305mm)	3.8	3.8	3.8	3.8	3.8	3.8	3.8	3.8

### Standard Output (SO)

Efficacy - Lumens per Watt	122	126	128	131	105	109	111	113
Lumens per foot (305mm)	727	750	766	781	627	647	660	673
Watts per foot (305mm)	6.1	6.1	6.1	6.1	6.1	6.1	6.1	6.1

### High Output (HO)

Efficacy - Lumens per Watt	113	116	119	121	97	100	102	104
Lumens per foot (305mm)	1382	1426	1455	1484	1192	1229	1254	1279
Watts per foot (305mm)	12.4	12.4	12.4	12.4	12.4	12.4	12.4	12.4

## Performance | Zipper Board Optics

Zipper Board Optics design has 72 diodes per foot (305mm).

### 120° FlyWing (G2)

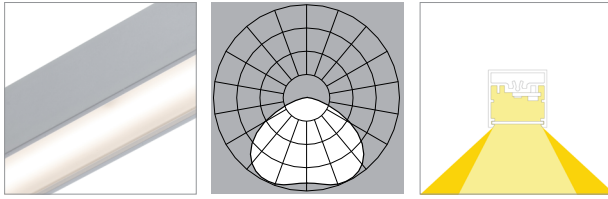

L80 >60,000 hours

Low Output (LO)	80 CRI (80min., 84 avg.)				90 CRI (90min., 96 avg.)			
	2700K	3000K	3500K	4000K	2700K	3000K	3500K	4000K
Efficacy - Lumens per Watt	90	93	95	97	78	80	82	83
Lumens per foot (305mm)	335	346	353	360	289	298	304	310
Watts per foot (305mm)	3.8	3.8	3.8	3.8	3.8	3.8	3.8	3.8

### Standard Output (SO)

Efficacy - Lumens per Watt	112	115	118	120	96	99	101	103
Lumens per foot (305mm)	670	691	705	719	578	596	608	620
Watts per foot (305mm)	6.1	6.1	6.1	6.1	6.1	6.1	6.1	6.1

### High Output (HO)

Efficacy - Lumens per Watt	104	107	109	112	90	93	94	96
Lumens per foot (305mm)	1273	1313	1340	1367	1098	1132	1155	1178
Watts per foot (305mm)	12.4	12.4	12.4	12.4	12.4	12.4	12.4	12.4

### 40° Symmetric (S1)

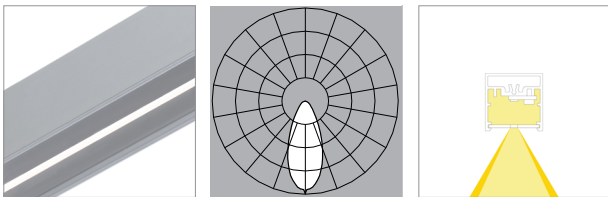

L80 >60,000 hours

Low Output (LO)	80 CRI (80min., 84 avg.)				90 CRI (90min., 96 avg.)			
	2700K	3000K	3500K	4000K	2700K	3000K	3500K	4000K
Efficacy - Lumens per Watt	42	43	44	45	36	37	38	39
Lumens per foot (305mm)	154	159	162	165	133	137	140	142
Watts per foot (305mm)	3.8	3.8	3.8	3.8	3.8	3.8	3.8	3.8

### Standard Output (SO)

Efficacy - Lumens per Watt	52	53	54	55	45	46	47	48
Lumens per foot (305mm)	308	317	324	330	265	273	279	285
Watts per foot (305mm)	6.1	6.1	6.1	6.1	6.1	6.1	6.1	6.1

### High Output (HO)

Efficacy - Lumens per Watt	48	49	50	51	41	43	44	44
Lumens per foot (305mm)	584	603	615	627	504	520	530	541
Watts per foot (305mm)	12.4	12.4	12.4	12.4	12.4	12.4	12.4	12.4

## Performance | Zipper Board Optics

Zipper Board Optics design has 72 diodes per foot (305mm).

### 60° Symmetric (S2)

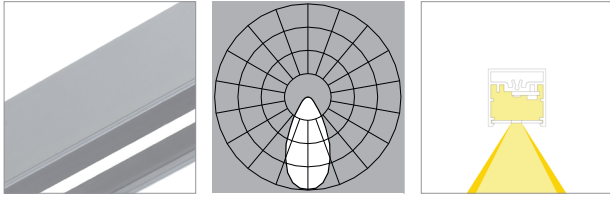

L80 >60,000 hours

Low Output (LO)	80 CRI (80min., 84 avg.)				90 CRI (90min., 96 avg.)			
	2700K	3000K	3500K	4000K	2700K	3000K	3500K	4000K
Efficacy - Lumens per Watt	52	53	54	55	45	46	47	48
Lumens per foot (305mm)	191	197	201	205	165	170	173	177
Watts per foot (305mm)	3.8	3.8	3.8	3.8	3.8	3.8	3.8	3.8

### Standard Output (SO)

Efficacy - Lumens per Watt	64	66	67	69	55	57	58	59
Lumens per foot (305mm)	382	394	402	410	329	340	347	354
Watts per foot (305mm)	6.1	6.1	6.1	6.1	6.1	6.1	6.1	6.1

### High Output (HO)

Efficacy - Lumens per Watt	59	61	63	64	51	53	54	55
Lumens per foot (305mm)	726	749	764	779	626	646	659	672
Watts per foot (305mm)	12.4	12.4	12.4	12.4	12.4	12.4	12.4	12.4

### 85° Asymmetric (A1)

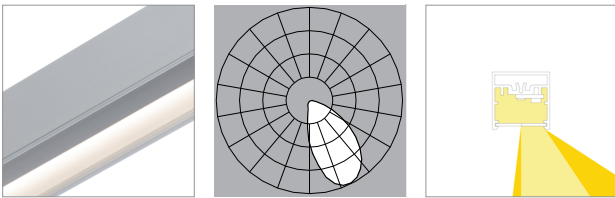

L80 >60,000 hours

Low Output (LO)	80 CRI (80min., 84 avg.)				90 CRI (90min., 96 avg.)			
	2700K	3000K	3500K	4000K	2700K	3000K	3500K	4000K
Efficacy - Lumens per Watt	66	68	69	71	57	59	60	61
Lumens per foot (305mm)	244	252	257	262	210	217	221	226
Watts per foot (305mm)	3.8	3.8	3.8	3.8	3.8	3.8	3.8	3.8

### Standard Output (SO)

Efficacy - Lumens per Watt	75	77	79	80	65	67	68	69
Lumens per foot (305mm)	488	503	513	524	420	434	443	451
Watts per foot (305mm)	6.6	6.6	6.6	6.6	6.6	6.6	6.6	6.6
CRI	-	-	-	-	-	-	-	-

### High Output (HO)

Efficacy - Lumens per Watt	76	78	80	81	65	67	69	70
Lumens per foot (305mm)	927	956	975	995	799	824	841	858
Watts per foot (305mm)	12.4	12.4	12.4	12.4	12.4	12.4	12.4	12.4

## Performance | Zipper Board Optics

Zipper Board Optics design has 72 diodes per foot (305mm).

### 40° Symmetric, black finish (S1-BL)

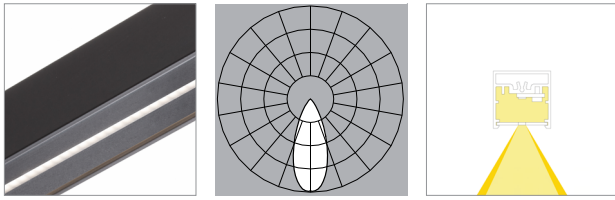

L80 >60,000 hours

Low Output (LO)	80 CRI (80min., 84 avg.)				90 CRI (90min., 96 avg.)			
	2700K	3000K	3500K	4000K	2700K	3000K	3500K	4000K
Efficacy - Lumens per Watt	32	33	33	34	28	29	29	30
Lumens per foot (305mm)	117	121	123	126	101	104	106	108
Watts per foot (305mm)	3.8	3.8	3.8	3.8	3.8	3.8	3.8	3.8
<b>Standard Output (SO)</b>								
Efficacy - Lumens per Watt	39	41	41	42	34	35	36	37
Lumens per foot (305mm)	234	242	247	252	202	208	213	217
Watts per foot (305mm)	6.1	6.1	6.1	6.1	6.1	6.1	6.1	6.1
<b>High Output (HO)</b>								
Efficacy - Lumens per Watt	37	38	39	39	32	33	33	34
Lumens per foot (305mm)	445	459	469	478	384	396	404	412
Watts per foot (305mm)	12.4	12.4	12.4	12.4	12.4	12.4	12.4	12.4

### 60° Symmetric, black finish (S2-BL)

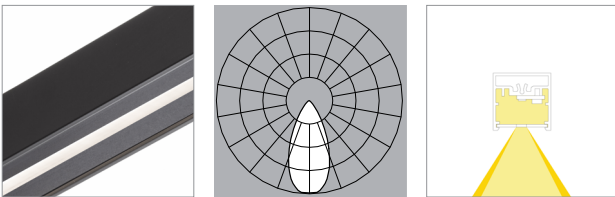

L80 >60,000 hours

Low Output (LO)	80 CRI (80min., 84 avg.)				90 CRI (90min., 96 avg.)			
	2700K	3000K	3500K	4000K	2700K	3000K	3500K	4000K
Efficacy - Lumens per Watt	39	40	41	41	33	34	35	36
Lumens per foot (305mm)	142	147	150	153	123	127	129	132
Watts per foot (305mm)	3.8	3.8	3.8	3.8	3.8	3.8	3.8	3.8
<b>Standard Output (SO)</b>								
Efficacy - Lumens per Watt	48	49	50	51	41	43	43	44
Lumens per foot (305mm)	285	294	300	306	245	253	258	263
Watts per foot (305mm)	6.1	6.1	6.1	6.1	6.1	6.1	6.1	6.1
<b>High Output (HO)</b>								
Efficacy - Lumens per Watt	44	46	47	48	38	40	40	41
Lumens per foot (305mm)	541	558	569	581	446	481	491	501
Watts per foot (305mm)	12.4	12.4	12.4	12.4	12.4	12.4	12.4	12.4

## Performance | Button Board Optics

Button Board Optics design has 72 diodes per foot (305mm).

### 85° Asymmetric, black finish (A1-BL)

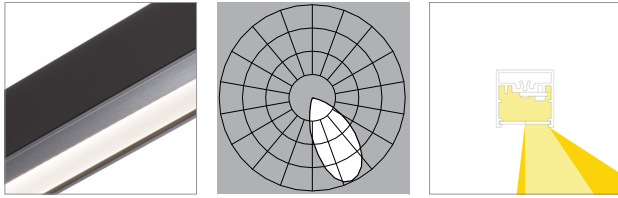

L80 >60,000 hours

	<b>80 CRI (80min., 84 avg.)</b>				<b>90 CRI (90min., 96 avg.)</b>			
	2700K	3000K	3500K	4000K	2700K	3000K	3500K	4000K
<b>Low Output (LO)</b>								
Efficacy - Lumens per Watt	35	36	36	37	30	31	32	32
Lumens per foot (305mm)	128	132	134	137	110	114	116	118
Watts per foot (305mm)	3.8	3.8	3.8	3.8	3.8	3.8	3.8	3.8
<b>Standard Output (SO)</b>								
Efficacy - Lumens per Watt	43	44	45	46	37	38	39	40
Lumens per foot (305mm)	255	263	269	274	220	227	232	236
Watts per foot (305mm)	6.1	6.1	6.1	6.1	6.1	6.1	6.1	6.1
	-	-	-	-				
<b>High Output (HO)</b>								
Efficacy - Lumens per Watt	40	41	42	43	34	36	36	37
Lumens per foot (305mm)	485	501	511	521	418	431	440	449
Watts per foot (305mm)	12.4	12.4	12.4	12.4	12.4	12.4	12.4	12.4

## Performance | Button Board Optics

Button Board Optics design has 72 diodes per foot (305mm).

### 19° x 48° Oval (19)

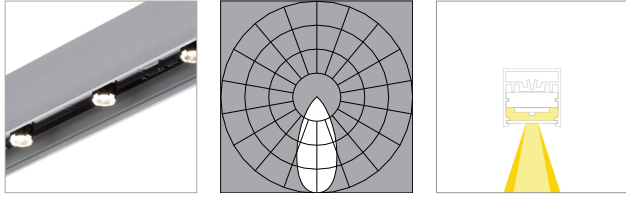

L80 >70,000 hours

#### 80 CRI (80min., 84 avg.)

<b>Standard Output (SO)</b>	2700K	3000K	3500K	4000K
Efficacy - Lumens per Watt	61	64	67	69
Lumens per foot (305mm)	423	441	460	478
Watts per foot (305mm)	6.9	6.9	6.9	6.9

#### High Output (HO)

Efficacy - Lumens per Watt	55	57	60	62
Lumens per foot (305mm)	648	673	701	729
Watts per foot (305mm)	11.7	11.7	11.7	11.7
	-	-	83	-

### 36° Medium (36)

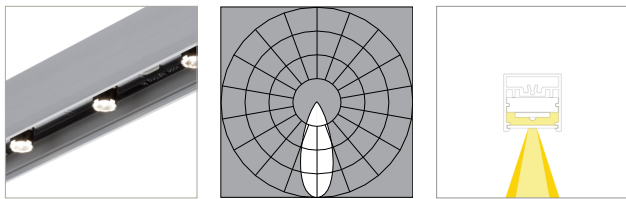

L80 >70,000 hours

#### 80 CRI (80min., 84 avg.)

<b>Standard Output (SO)</b>	2700K	3000K	3500K	4000K
Efficacy - Lumens per Watt	71	74	78	80
Lumens per foot (305mm)	492	513	534	556
Watts per foot (305mm)	6.9	6.9	6.9	6.9

#### High Output (HO)

Efficacy - Lumens per Watt	64	66	70	72
Lumens per foot (305mm)	747	778	810	843
Watts per foot (305mm)	11.7	11.7	11.7	11.7

Copyright © 2022 Vode Lighting LLC. All rights reserved. Vode, the Vode logo, BoxRail, FlyWing, MicroBaffle, Button Board, Zipper Board, Zero Canopy, Zero Block, VodeNODE and other names are either registered trademarks or trademarks of Vode Lighting LLC in the United States and may be registered in other countries. All other trademarks listed herein belong to their respective owners. Due to ongoing innovation, specification details may change without notice.