

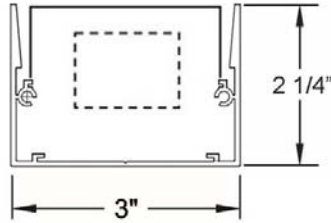

Click or scan QR code to view latest spec sheet



Revision Date: May 18, 2022  
Gammalux Lighting Systems reserves the right to change details of fixture designs and construction at any time.



**LED LAMPING**

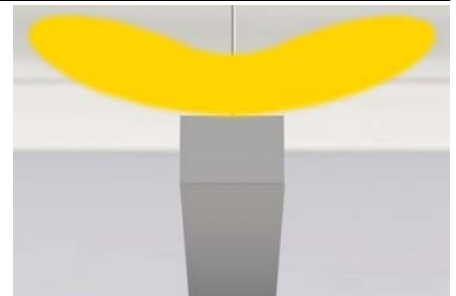

Click photo to view product page  
Page 1: Overview & Nomenclature  
Pages 2-3: Specifications  
Pages 4-6: Photometric Info / Downloads  
Page 7: Mounting Details  
Pages 9-11: Product Matrix, Custom Programming, Wood Finish  
Pages 12-15: Application Guides

**Product Overview** (for complete specifications, see pages 2 & 3)

**NEW GradientGuide Optic:** Why specify Gammalux GradientGuide Optic?

Simply stated, Gammalux understood the necessity to “tame” the intensity of LEDs in indirect lighting applications. By refracting the light output from multiple LED sources through a proprietary optical array, we created optimal near-field photometry. The result: a beautiful, smooth, even ceiling gradient illumination along with an extremely wide distribution and a reduction in overall source brightness. Oh, BTW, we also eliminated the harsh striations and cut-off found in typical batwing designs. Is our new GradientGuide Optic better than a “batwing”? **You be the judge.** Gammalux understands quality of light, & what’s important for “your design intent”!

**Construction:** ARRA, RoHS, REACH and Prop 65 compliant. Extruded aluminum housing for superior fit and finish. Runs and complex patterns are ordered, built and shipped with a single item # and can be built to match field conditions.

**Electrical:** LED components by major manufacturers. Fixtures can be fitted with integral sensors, control interface devices and specialty LED components (consult factory). Standard Output, High Output, Very High Output and Custom Output options available.

**Standard Nomenclature**

<p><b>Manufacturer</b> Gammalux</p> <p><b>Cross Section (nom)</b> 3" x 2"</p> <p><b>Distribution</b> U Indirect</p>	<p><b>Output</b> S Standard Output H High Output V Very High Output C Custom Output (see addendum page)</p> <p><b>Color Temp. (nom)</b> 27 2700K 40 4000K 30 3000K 50 5000K 35 3500K</p> <p><b>Color Temp. (nom)</b> 27 2700K 40 4000K 30 3000K 50 5000K 35 3500K</p> <p><b>CRI**</b> 8 for 80+ 9 for 90+</p> <p><b>Lamp</b> LED</p> <p><b>Voltage</b> 120V, 277V, UNIV</p> <p><b>LED Arrays in X-Sec</b> 2</p>	<p><b>Driver</b> ZTV10 0-10V Dim to 10% For all options, see next page</p> <p><b>Length Option</b> N Nominal S Specific</p> <p><b>Run or Pattern</b> Specify total run length (i.e. 43' 5 1/8") For illuminated patterns, follow overall length or dimensions with L, T, X, U, RECT or SQ (i.e. 43' 5 1/8" RECT or 10' X 10' SQ). If overall length or dims are unknown, use TBD and follow with L, T, X, U, RECT or SQ (i.e. TBD RECT or TBD SQ). Consult factory for complex or multi-plane patterns.</p>	<p><b>Mounting Method</b> C Cable S Swivel Stem SEQ CA Earthquake Stems/Fittings SF Surface WM Wall Mount, Flush WSP Wall Spacer, 1/2"</p> <p><b>Suspension Length</b> Distance to top of fixture. If not suspended, leave blank.</p>	<p><b>Paint Colors</b> W White (See color chart for other colors) CCM Custom Color Match For wood finishes, see addendum page</p> <p><b>Paint Finish</b> H High Gloss SG Semi-Gloss</p> <p><b>Options</b> BPE Battery Pack (4' section) DL UL Damp Label EMERG Emergency Ckt ZCKT Dual Circuiting SBO Sensor By Others#</p> <p><b>Shielding</b> GGMS GradientGuide Mid-range suspension Symmetric Optic</p>			
<p><b>Model</b> 2<sup>nd</sup> Gen</p> <p><b>Series</b> Beam</p>	<p><b>Model</b> 2<sup>nd</sup> Gen</p> <p><b>Series</b> Beam</p>	<p><b>Model</b> 2<sup>nd</sup> Gen</p> <p><b>Series</b> Beam</p>	<p><b>Model</b> 2<sup>nd</sup> Gen</p> <p><b>Series</b> Beam</p>	<p><b>Model</b> 2<sup>nd</sup> Gen</p> <p><b>Series</b> Beam</p>	<p><b>Model</b> 2<sup>nd</sup> Gen</p> <p><b>Series</b> Beam</p>	<p><b>Model</b> 2<sup>nd</sup> Gen</p> <p><b>Series</b> Beam</p>	<p><b>Model</b> 2<sup>nd</sup> Gen</p> <p><b>Series</b> Beam</p>

\*\* 90+ CRI option increases wattage by nom. 14.5%. # Sensor By Others, factory installed (consult factory).

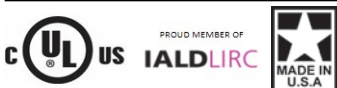

## Specifications (continued on next page)

### Electrical

**Output:** Standard (**S**) and high (**H**) options deliver a pre-set lumen package (see chart below). Custom-programmed output (**C**) is specified as LPF, WPF or % of High Output (see Custom Programmed Output page).

**Static Driver:** eldoLED **Optotronic\*** programmable driver, wired for static operation (**DVR**).

**0-10V Dimming:** eldoLED **Optotronic\*** programmable driver, wired for 0-10v control and dimming to 10% (**ZTV10**) or to 1% (**ZTV1**). For 0-10v dimming to 1% in lengths other than 1' increments, consult factory.

**Step Dimming:** Generic step dimming driver, two hot inputs for 100% and 50% output (**SD2**).

**DALI Dimming:** Generic DALI driver with two loose control wires exiting fixture at power feed location (**DALI**).

**Lutron Dimming:** **Hi-lume LTE** dim to 1% 2-wire 120V forward phase (**LTEA2WA** for PWM providing smoothest dimming or **LTEA2WC** for CCR in applications with EMI requirements). **Hi-Lume** dim to 1% EcoSystem with Soft-On, Fade-to-Black (**LDE1**).

**White Emitter:** Nichia 757G emitters\* binned within 3 MacAdam ellipses in Osram or Gammalux proprietary array. 90+ CRI option with extended lead time (CRI code **9**) results in nominal 14.5% drop in efficacy; increase calculated wattage by 14.5%.

**Battery Pack:** Bodine **BSL310LP\*** (**BPE**). 4W max input, 10W initial output, delivers min. 27% of High Output value per 4' length.

**LED System:** 70% lumen output (L70) at max 85 degrees C calculated at >60k hours. Fixtures are shipped with anti-static gloves to minimize the risk of damage to LEDs during installation. [5 year limited warranty](#).

**Upgrade Capability:** LED assemblies can be replaced in the future with the latest factory-provided and fully warranted components. On-board sensors, control interface devices and alternate LED components may be specified (consult factory). Fixtures bear UL & cUL Dry Location label. Damp Location label available (**DL**).

\*Subject to availability; may be substituted by Gammalux. Components and specifications may be changed without notice.

LUMENS AND WATTS BY OUTPUT OPTION AND LED COLOR @ 80+ CRI*											
STANDARD OUTPUT LED						HIGH OUTPUT LED					
GRADIENTGUIDE (GGMS) DELIVERS: <b>452.4 LPF</b>						GRADIENTGUIDE (GGMS) DELIVERS: <b>605 LPF</b>					
<b>FOR VERY HIGH OUTPUT SEE PAGE 6</b>											
CCT	2700 K	3000 K	3500 K*	4000 K	5000 K	CCT	2700 K	3000 K	3500 K*	4000 K	5000 K
WATTS / FT.	6.7	6.4	6.3	6.2	5.9	WATTS / FT.	8.3	8	7.8	7.6	7.3
* IES FILES WERE CREATED USING 3500 K DIODES @ 80+ CRI. WATTAGE IS MULTIPLIED BY 1.06 FOR 2700 K, 1.02 FOR 3000 K, .98 FOR 4000 K AND .93 FOR 5000 K DIODES TO MAINTAIN THE SAME DELIVERED LUMENS THROUGHOUT ALL COLOR TEMPERATURES. FOR 90+ CRI, INCREASE WATTAGE BY 14.5%. SEE ADDENDUM FOR CUSTOM PROGRAMMING.											

### Construction

**Housing:** ARRA, RoHS, REACH and Prop 65 compliant. Extruded aluminum body 3.00" wide x 2.25" high, 6063T5, 0.070" min thickness. Each housing is 12' max unless longer housings are pre-coordinated with the factory to reduce joints and installation labor. Fixtures are built per approved factory drawings and tested as a complete system at the factory. Continuous runs and patterns are ordered, built and shipped with a single item #. Fixtures ordered as individuals are not designed to be joined together in the field.

**Joiner System:** Automatic alignment, no loose parts, one tool to tighten factory installed bolts for hairline seam. No light leaks.

**Lamping:** Patterns are fully illuminated. Runs ordered in Specific Length (Length Option **S**) will be built to the exact dimension shown on signature-approved shop drawings. Runs ordered in Nominal Length (Option **N**) may be factory-adjusted to accommodate standard mounting positions or grid centers. Factory drawings will show all dimensions for approval prior to production. Fixtures built to less than 4' may require master/satellite driver installation - consult factory.

**Mounting:** Aircraft cable is 7x7 stranded stainless steel with stopper fitting at the top end. Lower end strands are welded and ground for easy insertion into adjustable cable gripper (**C**). Feed cord is straight, white 3/C SVT or SJT #18 AWG. Stems are 3/8" schedule 40 pipe with top swivels (**S**). California UBC compliant stems with internal safety cables available (**SEQ**). Direct to surface mounting available for indirect illumination (**SF**). Housing can be mounted direct to wall (**WM**). Wall Spacer mounting (**WSP**) allows projection from wall of 3.50" to meet ADA requirements.

## Specifications (continued)

### Optical

**Reflectors:** Shall be formed diffuse high reflectance aluminum.

**GradientGuide Optic:** Proprietary ultra-wide distribution array optimized for 12" to 24" suspension (**GGMS**).

### Finish

Acid etched or clear anodized housing electrostatically sprayed with high solids aliphatic two component polyurethane high (**H**) or semi-gloss (**SG**) to an avg. thickness of 2 mils. Custom finish, consult factory. Wood Finishes, back page.



### Packing and Shipping

Fixtures built for continuous rows and patterns are given a specific location identifier, clearly identified on factory layout drawings, the fixture's ID Label, protective wrapping and on each end of fixture carton. Shipping pallets are built with 2" clearance, extending beyond the length and width of cartons, providing shipping protection.

Approx. weight of 4' module is 12 lbs. including carton. Weight of pallet and supplemental packing materials not factored in.

### Optimized Optics

This product is optimized for the best ceiling illumination at 12" to 24" suspension.

Photometric Reports for  
**STANDARD OUTPUT FIXTURES**

**FIXTURE USES GRADIENTGUIDE OPTIC AND 3500K LEDs @ 80+ CRI**

IESNA: LM-63-2002  
ISSUEDATE: 8/10/2020  
TEST: 13441844.01  
TESTLAB: UL VERIFICATION SVCS, INC.  
MANUFAC: GAMMALUX LTG SYS  
LUMCAT: GB32U225L358GGMS  
LAMPS: 288 WHITE LEDs

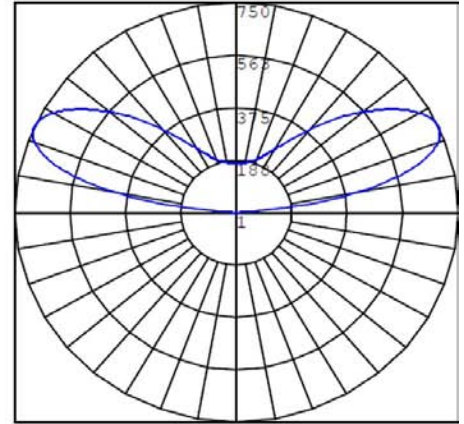
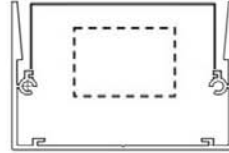

EFFICACY (TOTAL): 78.7 LPW  
DISTRIBUTION % UP: 100% (452.4 LPF)  
DISTRIBUTION % DN: 0%  
CIE CLASSIFICATION: INDIRECT

LUMINOUS OPENING: RECTANGULAR  
WIDTH: 2.5 in.  
LENGTH: 49 in.  
HEIGHT: .36 ft  
INPUT WATTS: 23.00 per 4'



**Photometric Reports for  
HIGH OUTPUT FIXTURES**

**FIXTURE USES GRADIENTGUIDE OPTIC AND 3500K LEDs @ 80+ CRI**

IESNA: LM-63-2002  
ISSUE DATE: 8/10/2020  
TEST: 13441844.02  
TESTLAB: UL VERIFICATION SVCS, INC.  
MANUFAC: GAMMALUX LTG SYS  
LUMCAT: GB32U22HL358GGMS  
LAMPS: 288 WHITE LEDs

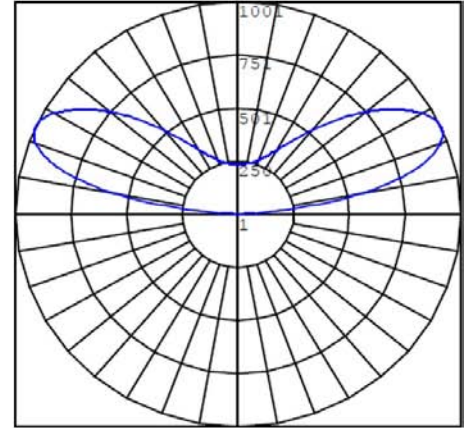
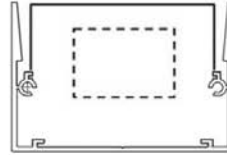

EFFICACY (TOTAL): 79.3 LPW  
DISTRIBUTION % UP: 100% (605 LPF)  
DISTRIBUTION % DN: 0%  
CIE CLASSIFICATION: INDIRECT

LUMINOUS OPENING: RECTANGULAR  
WIDTH: 2.5 in.  
LENGTH: 49 in.  
HEIGHT: .36 ft  
INPUT WATTS: 30.52 per 4'





**Photometric Info / Downloads**

**FIXTURE USES GRADIENTGUIDE OPTIC AND 3500K LEDs @ 80+ CRI**

IESNA: LM-63-2002  
ISSUEDATE: 8/10/2020  
TEST: 13441844.03  
TESTLAB: UL VERIFICATION SVCS, INC.  
MANUFAC: GAMMALUX LTG SYS  
LUMCAT: GB32U22VL358GGMS  
LAMPS: 288 WHITE LEDs

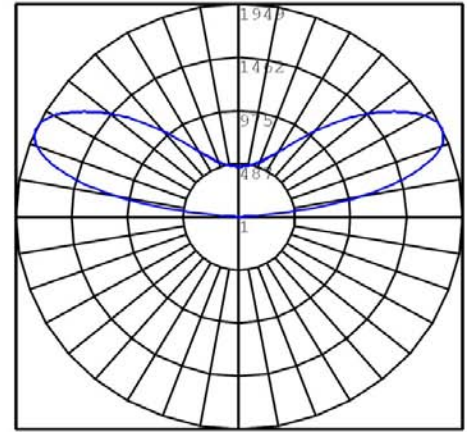
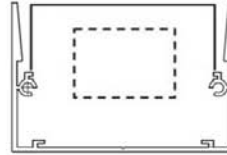

EFFICACY (TOTAL): 74.4 LPW  
DISTRIBUTION % UP: 100% (1182.4 LPF)  
DISTRIBUTION % DN: 0%  
CIE CLASSIFICATION: INDIRECT

LUMINOUS OPENING: RECTANGULAR  
WIDTH: 2.5 in.  
LENGTH: 49 in.  
HEIGHT: .36 ft  
INPUT WATTS: 63.57 per 4'



## Mounting Details

**Factory Drawings:** Fully dimensioned factory drawings will be provided upon receipt of purchase order.

### Cable Mount:

Specify **C** code in catalog #

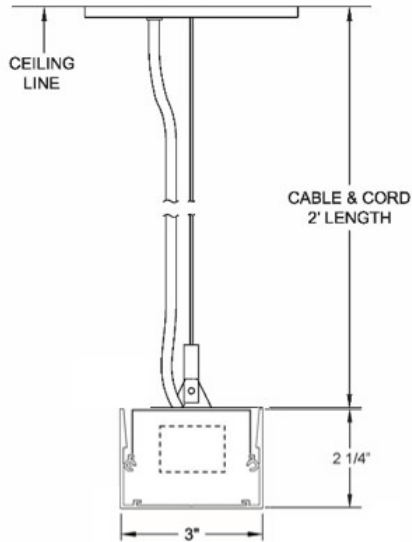

### Swivel Stem Mount:

Specify **S** code in catalog #

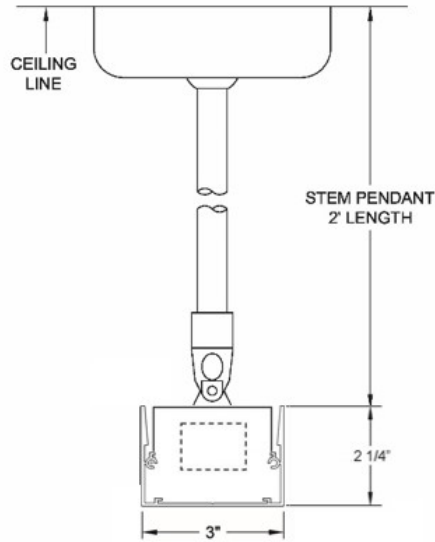

### CA Earthquake Stem Mount:

Specify **SEQ** code in catalog #

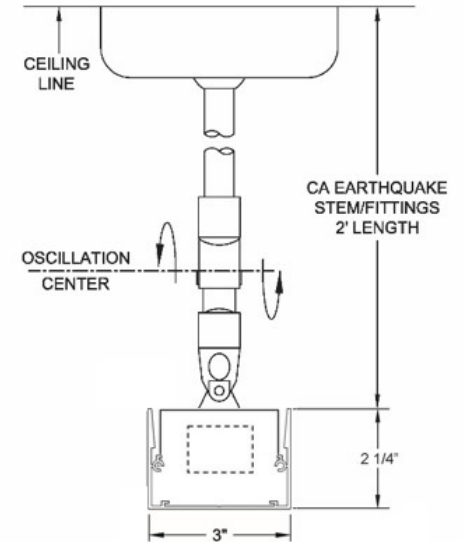

### Surface Mount:

Specify **SF** code in catalog #

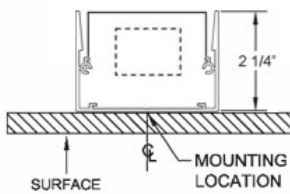

### Wall Mount:

Specify **WM** code in catalog #

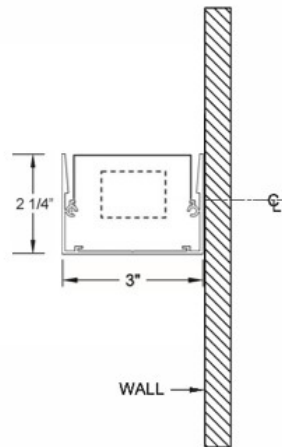

Gammalux Lighting Systems reserves the right to change the details of fixture design and construction at any time.

## GradientGuide Options

Each G-Beam configuration below delivers smooth, even ceiling gradient illumination. Specify the G-Beam rectilinear form factor that works with *your design intent*.

GB32U2 Indirect 3" W x 2" H

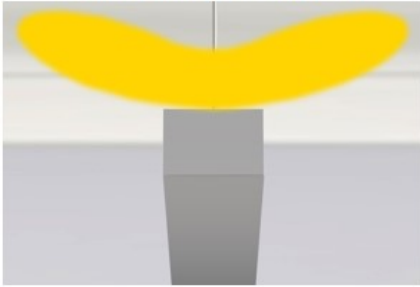

GB33B2 Bi-Directional 3" W x 3" H

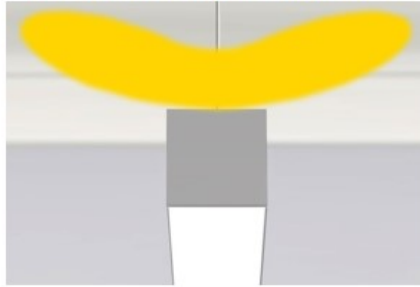

GB33U2 Indirect 3" W x 3" H

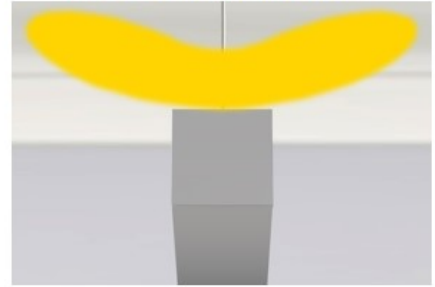

GB34U2 Indirect 3" W x 4" H

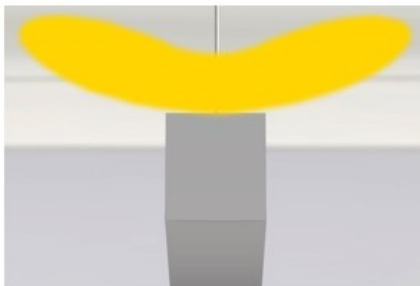

GB43U2 Bi-Directional 4" W x 3" H

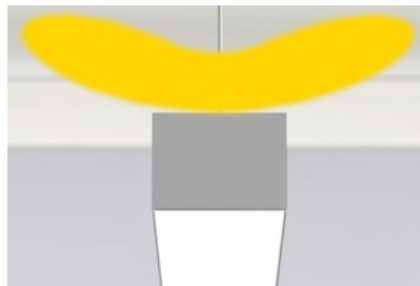

GB44U2 Indirect 4" W x 4" H

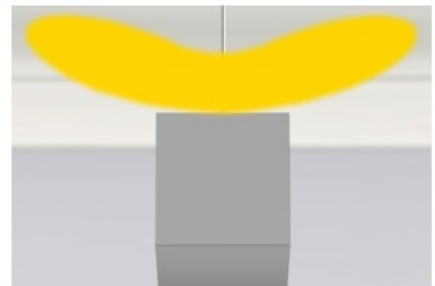

GB62U Indirect 6" W x 2" H





---

## Custom Programmed Output

---

**Custom Programmed Output** can be specified to produce approximate Delivered Lumens per Foot, Percentage of High Output Value or Maximum Watts per Foot.

### Delivered Lumens Per Foot

Gammalux deals only in delivered lumens per foot. When working to match or exceed a competitor product's Lumens Per Foot package, be sure you are looking at their Delivered (through the lens) lumens per foot, not their System (bare board) lumens per foot.

In the Gammalux item #, use **C** as the Output designator and add a fixture description stating the required Lumens Per Foot value (ie: if you need 600 lumens per foot delivered by the fixture, the line note would read "Program = 600 LPF").

### Percentage of High Output Value

If the required delivered lumens per foot are not known, run lighting calculations using our High Output IES file and identify the percentage of increase or decrease required to produce the correct lighting in the space.

In the Gammalux item #, use **C** as the Output designator and add a fixture description stating the required percentage of decrease from our High Output value (ie: for 60% of our High Output value, the line note would read "Program = 60% of High Output").

### Maximum Watts Per Foot

In the Gammalux item #, use **C** as the Output designator and add a fixture description stating the required Maximum Watts per Foot (ie: if you need the fixtures capped at a maximum of 7 watts per foot, the line note would read "Program = 7 WPF").

For all three methods, custom programming capability is currently 25-200% of our High Output value. For requirements outside of this range, consult factory.

## Wood Finishes

Fixture housings are powder coated with a base finish, baked, then wrapped in a film with the decorative grain pattern. Baking the housing again allows the grain to become embedded into the powder coated finish. This is not a decal or veneer. Additional lead time and cost increases apply. Consult factory for pricing. Swatches are scaled accurately for 8.5" x 11" page.

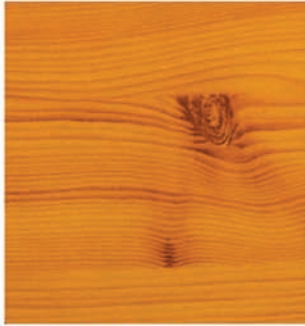

FINISH CODE: KPI



FINISH CODE: MED



FINISH CODE: HCH



FINISH CODE: WAL



FINISH CODE: AOK

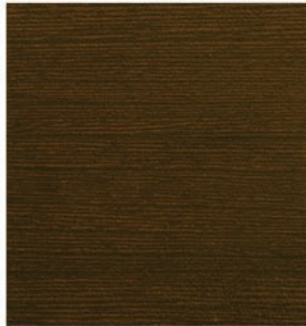

FINISH CODE: FWG

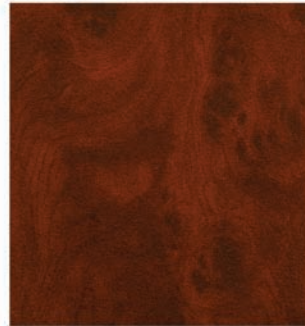

FINISH CODE: MH1



FINISH CODE: MH2



SAMPLE FIXTURE WITH WOOD FINISH



**DUE TO VARIANCES IN MONITORS AND PRINTERS, ACTUAL FINISHES MAY APPEAR DIFFERENT FROM SWATCHES.**

## Application Guide for GGMS with 8' on-center mounting

These examples are using 80% ceiling reflectivity in a 50' wide room. High Output luminaire suspended on 8' mounting centers. Area of analysis is delineated by dotted blue lines.

GGMS, 24" suspension, 8' on center row mounting, max\min ceiling ratio of **1.16:1**

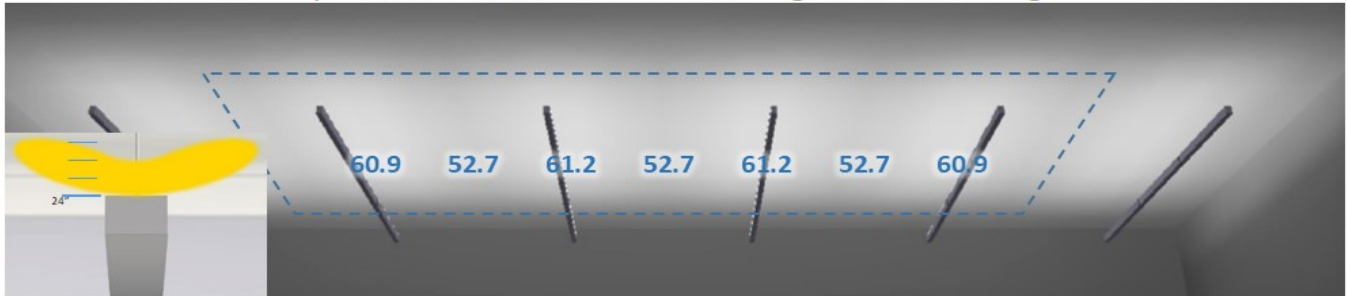

GGMS, 18" suspension, 8' on center row mounting, max\min ceiling ratio of **1.56:1**

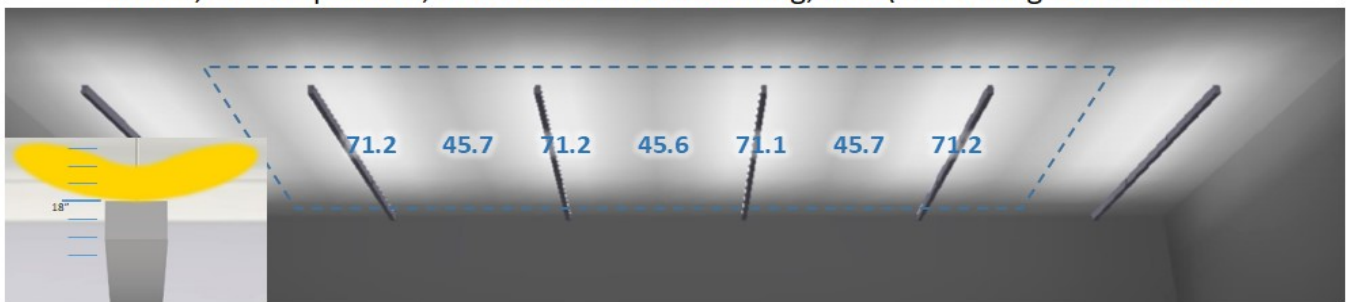

GGMS, 15" suspension, 8' on center row mounting, max\min ceiling ratio of **2.01:1**

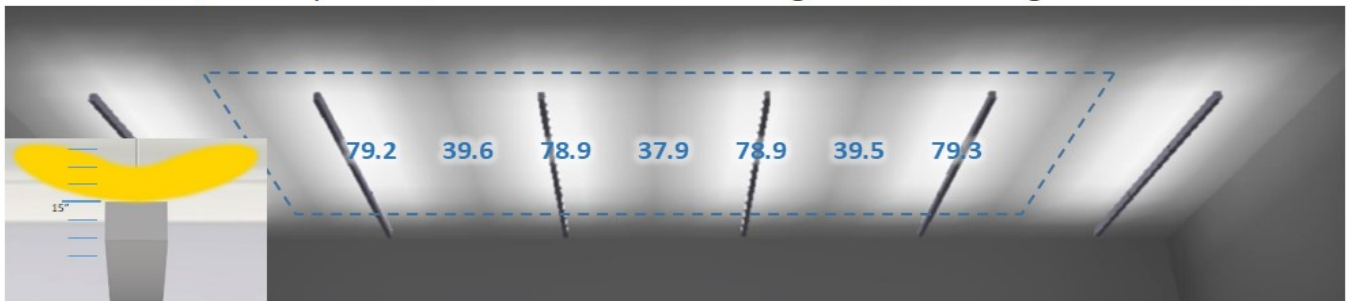

GGMS, 12" suspension, 8' on center row mounting, max\min ceiling ratio of **3.02:1**

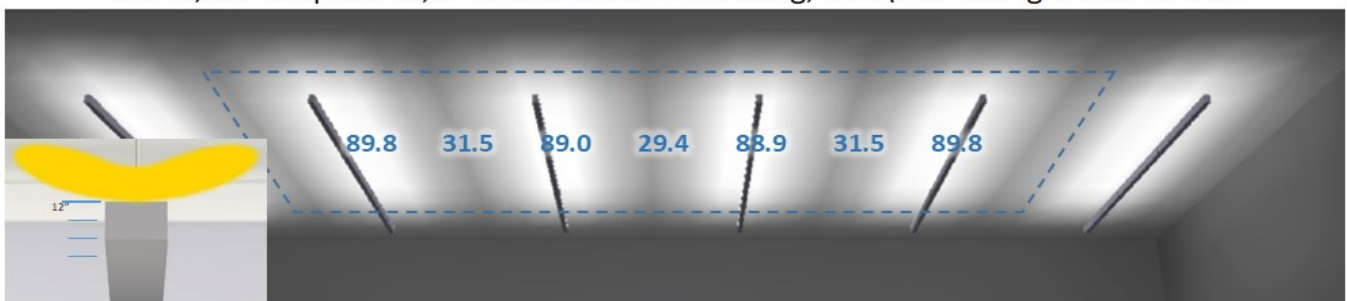

Renderings created by AGi32



## Application Guide for GGMS with 12' on-center mounting

These examples are using 80% ceiling reflectivity in a 50' wide room. High Output luminaire suspended on 12' mounting centers. Area of analysis is delineated by dotted blue lines.

GGMS, 24" suspension, 12' on center row mounting, max\min ceiling ratio of **2.27:1**

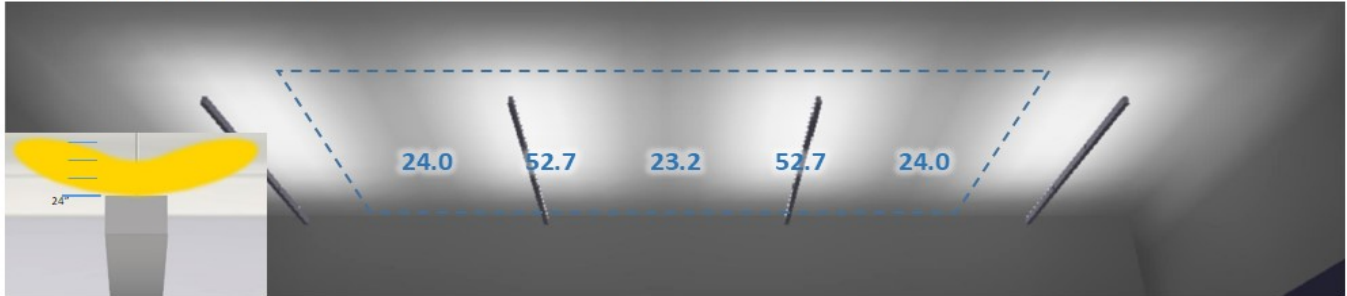

GGMS, 18" suspension, 12' on center row mounting, max\min ceiling ratio of **4.03:1**

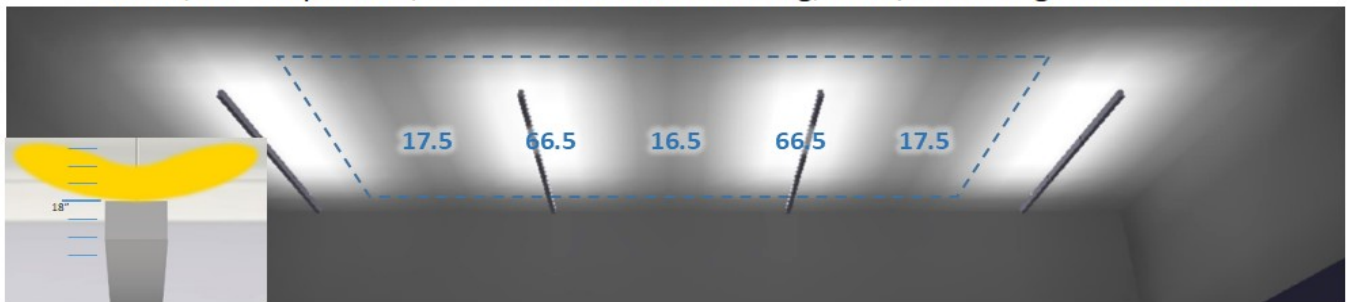

GGMS, 15" suspension, 12' on center row mounting, max\min ceiling ratio of **5.93:1**

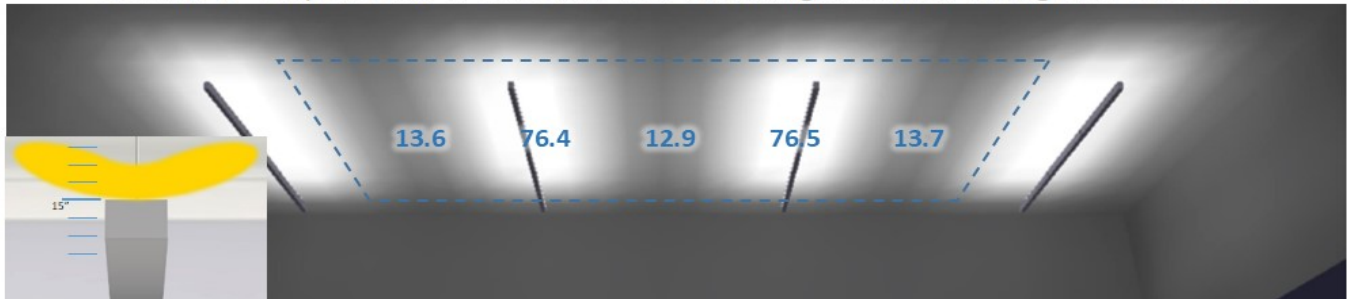

GGMS, 12" suspension, 12' on center row mounting, max\min ceiling ratio of **9.51:1**

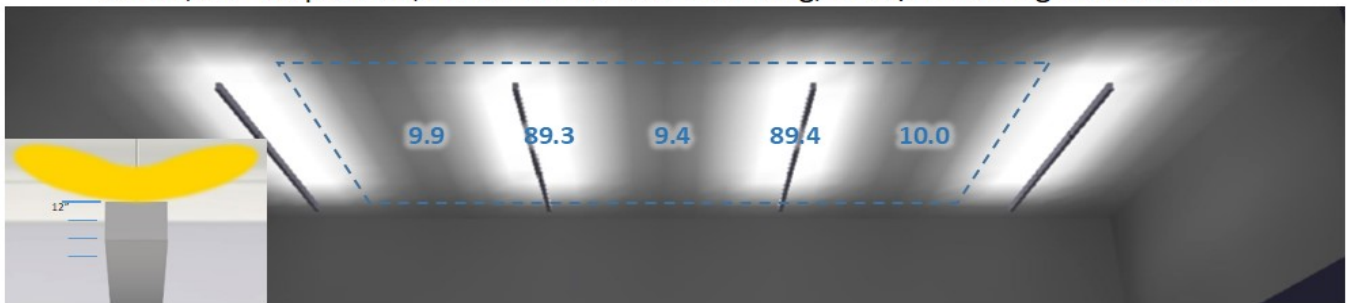

Renderings created by AGi32

## Application Guide for GGMS with 14' on-center mounting

These examples are using 80% ceiling reflectivity in a 50' wide room. High Output luminaire suspended on 14' mounting centers. Area of analysis is delineated by dotted blue lines.

GGMS, 24" suspension, 14' on center row mounting, max\min ceiling ratio of 3.12:1

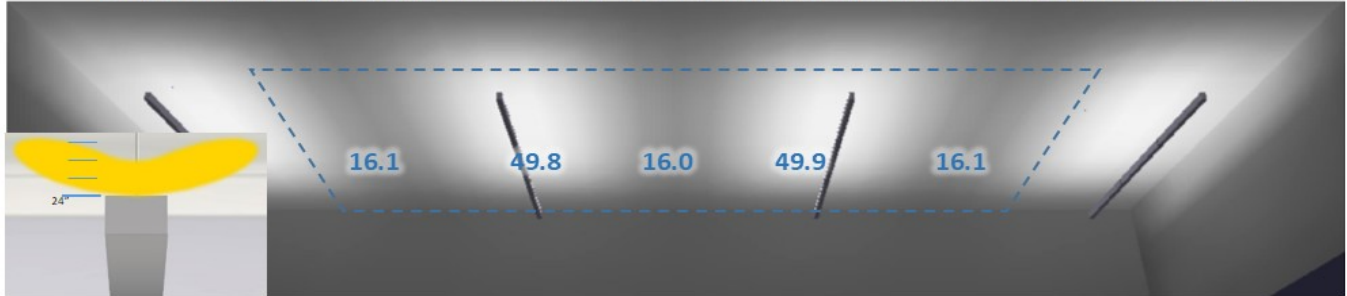

GGMS, 18" suspension, 14' on center row mounting, max\min ceiling ratio of 5.63:1

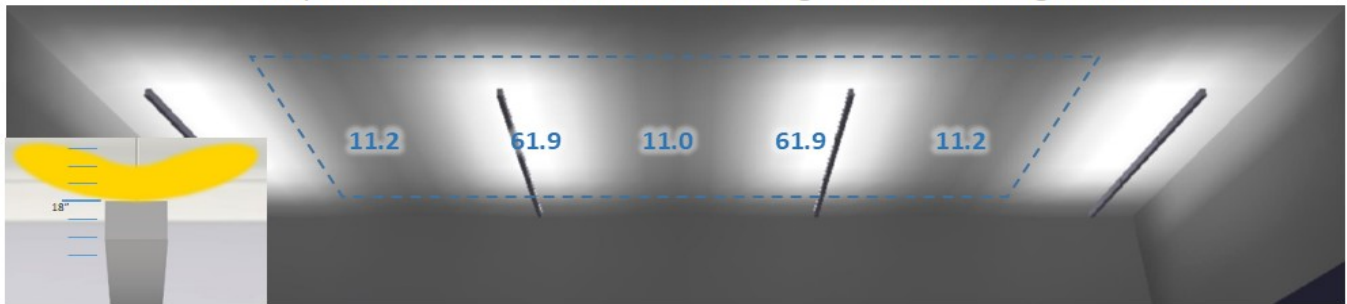

GGMS, 15" suspension, 14' on center row mounting, max\min ceiling ratio of 8.13:1



GGMS, 12" suspension, 14' on center row mounting, max\min ceiling ratio of 12.42:1



Renderings created by AGi32



## Application Guide for GGMS with 16' on-center mounting

These examples are using 80% ceiling reflectivity in a 50' wide room. High Output luminaire suspended on 16' mounting centers. Area of analysis is delineated by dotted blue lines.

GGMS, 24" suspension, 16' on center row mounting, max\min ceiling ratio of **4.57:1**

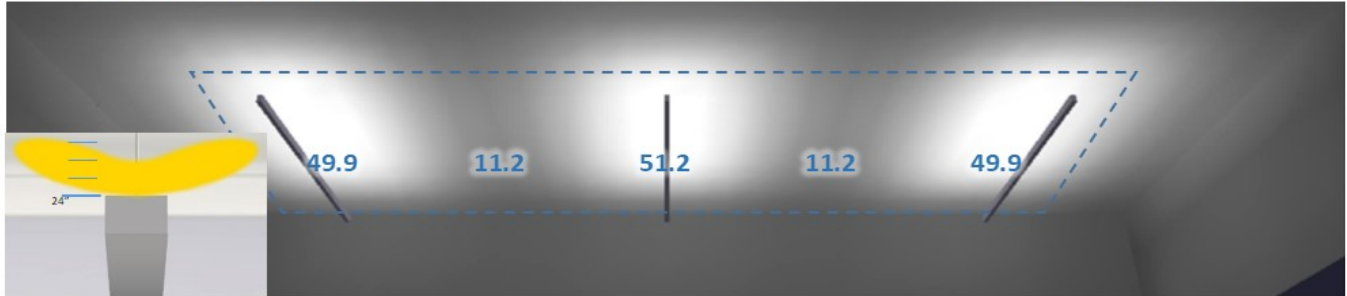

GGMS, 18" suspension, 16' on center row mounting, max\min ceiling ratio of **8.74:1**

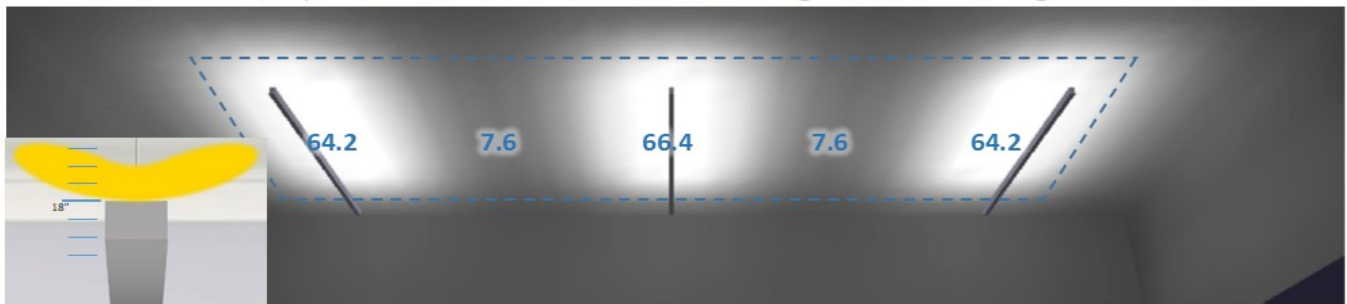

GGMS, 15" suspension, 16' on center row mounting, max\min ceiling ratio of **13.17:1**

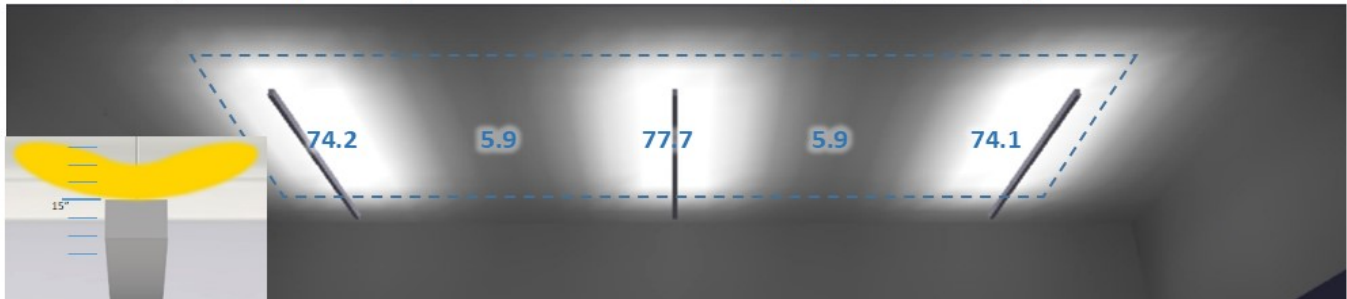

GGMS, 12" suspension, 16' on center row mounting, max\min ceiling ratio of **21.0:1**

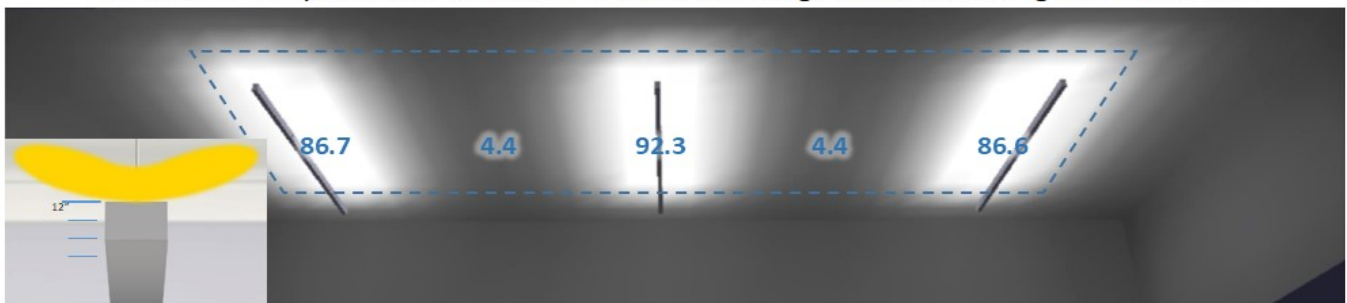

Renderings created by AGi32