

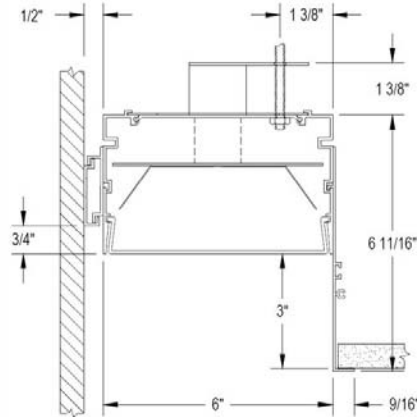

Click or scan QR code to view latest spec sheet

See Brochure

Revision Date: December 08, 2023
Gammlux Lighting Systems reserves the right to change details of fixture designs and construction at any time.



LED Lamping



Click photo to view product page
Page 1: Overview & Nomenclature
Pages 2-3: Specifications
Pages 4-11: Photometric Info / Downloads
Pages 12-14: Mounting Details
Page 16: Custom Programming
Pages 17-20: Length and GAMMALUX EZ-TELE™

Product Overview (for complete specifications, see pages 2 & 3) *****NEW***** See last page for **APPROVED CUT RELEASE**.

Quick Ship: Most product options are shippable within 2-3 weeks! **Check our Quick Ship Guide for details.**

Why specify Gammlux Perimeter Systems?

Let's start with the broadest array of apertures sizes; 1", 2", 3", 4", 5" & 6" along with your choice of regress depths. Also, note the shallow housing cross section heights. All of that with our new GAMMALUX EZ-TELE™ telescoping module for fast installation (U.S. PATENT No. 11,384,923, pg. 15) with Chicago Plenum compliance. The result? The GPD series is your versatile, affordable linear wall slot system. Gammlux understands quality of light, & what's important for "your design intent"!

Construction: I.C. rated. ARRA, RoHS, REACH and Prop 65 compliant. Extruded aluminum housing for superior fit and finish. Runs and patterns have a single item # and can be built to field dims. Up to 3" lens regress with continuous illumination in custom-length runs and patterns with illuminated corners.

Standard Nomenclature

Quick Ship Eligible
Most options 2-3 weeks*

<p>Manufacturer Gammlux</p> <p>Housing width 6"</p> <p>Distribution Direct</p> <p>Series Perimeter</p>	<p>Output S Standard Output H High Output C Custom Output see addendum page</p> <p>Color Temp. (nom) 27 2700K 40 4000K 30 3000K 50 5000K 35 3500K RGB/RGBW consult factory</p> <p>CRI** 8 for 80+ 9 for 90+</p> <p>Lamp LED</p>	<p>Driver ZTV10 0-10V Dim to 10% ZTV1 0-10V Dim to 1% For all options, see next page</p> <p>Length Option (length details page) N Nominal VIF Verify In Field do not use VIF with EZT</p> <p>Voltage 120V, 277V, 347V, UNIV (120-277V)</p> <p>LED/Housing Option Blank Run is non-telescoping. EZT Telescoping module allows nominal 6" field adjustability for fast installation. (see page 14)</p>	<p>Ceiling Interface and Regress</p> <table border="1" style="font-size: small;"> <tr> <td>GFR</td> <td>0 No regress</td> </tr> <tr> <td>Gyp or grid w/ .5" flange</td> <td>1 1" regress</td> </tr> <tr> <td>GMR</td> <td>2 2" regress</td> </tr> <tr> <td>Gyp w/ mud flange</td> <td>3 3" regress</td> </tr> </table> <p>Wall Interface A Adjustable wall bracket</p>	GFR	0 No regress	Gyp or grid w/ .5" flange	1 1" regress	GMR	2 2" regress	Gyp w/ mud flange	3 3" regress	<p>Paint Option A Antimicrobial Blank Standard</p> <p>Paint Finish H High Gloss SG Semi-Gloss</p> <p>Paint Colors W White see color chart for other colors CCM Custom Color Match</p>
GFR	0 No regress											
Gyp or grid w/ .5" flange	1 1" regress											
GMR	2 2" regress											
Gyp w/ mud flange	3 3" regress											
GPD6 - SL358EZT - UNIV - ZTV10 - 4'N - RECW/A/GFR3 - ASLMD - WSGA -												
<p>Mounting REC Recessed intra-wall (images, page 9) RECW*** Recessed wall-to-wall (images, pg. 10)</p> <p>Run or Pattern Specify total run length (i.e. 43' 5 1/8") For runs with EZ-TELE™, indicate designed run length. Factory drawings will show field adjustability + and -. For patterns, indicate pattern dimension (i.e. 4'X12'6"L, 3'3"x17'T, 2'X4'X, 6'X13'REC, 10'X10'SQ). Consult factory for complex or multi-plane patterns.</p> <p>Options BPE Battery Pack (4' section) DL UL Damp Label EMERG Emergency Ckt 2CKT Dual Circuiting SBO Sensor By Others# CP Chicago Plenum</p> <p>Shielding ASLMD Acrylic Satin Lens, Medium Diffuse ASLHD Acrylic Satin Lens, Heavy Diffuse</p>												

** 90+ CRI increases watts nom. 14.5%. *** Field dims. required if not using GAMMALUX EZ-TELE™. # Sensor by Others (consult factory).
*Some restrictions apply. **Check our Quick Ship Guide for details.**

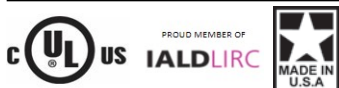

Specifications (continued on next page)

Electrical

Output: Standard (**S**) and high (**H**) options deliver a pre-set lumen package (see chart below). Custom-programmed output (**C**) is specified as LPF, WPF or % of High Output (see Custom Programmed Output page).

Static Driver: eldoLED **Optotronic*** programmable driver, wired for static operation (**DVR**).

0-10V Dimming: eldoLED **Optotronic*** programmable driver, wired for 0-10v control and dimming to 10% (**ZTV10**) or to 1% (**ZTV1**).

Step Dimming: Generic step dimming driver, two hot inputs for 100% and 50% output (**SD2**).

DALI Dimming: Generic DALI driver with two loose control wires exiting fixture at power feed location (**DALI**).

Lutron Dimming: **Hi-Lume** dim to 1% EcoSystem with Soft-On, Fade-to-Black (**LDE1**).

White Emitter: Nichia 757G emitters* binned within 3 MacAdam ellipses in Osram or Gammalux proprietary array. 90+ CRI option with extended lead time (CRI code **9**) results in nominal 14.5% drop in efficacy; increase calculated watts 14.5%.

Battery Pack: Bodine **BSL10T3*** (**BPE**). 4W max input, 10W initial output, delivers min. 27% of High Output value per 4' length.

LED System: 70% lumen output (L70) at max 85 degrees C calculated at >60k hours. Fixtures are shipped with anti-static gloves to minimize the risk of damage to LEDs during installation. [5 year limited warranty](#).

Sensors: Sensors are as specified, confirmed by Gammalux prior to factory quote. Examples are Enlighted [Micro Sensor](#), Lutron [Athena Wireles Node](#), Lutron [Vive](#), Wattstopper [FS-205](#).

Upgrade Capability: LED assemblies can be replaced in the future with the latest factory-provided and fully warranted components. On-board sensors, control interface devices and alternate LED components may be specified (consult factory). Fixtures bear UL & cUL Dry Location label. Damp Location label available (**DL**).

*Subject to availability; may be substituted by Gammalux. Components and specifications may be changed without notice.

LUMENS AND WATTS BY OUTPUT OPTION AND LED COLOR @ 80+ CRI*											
STANDARD OUTPUT LED						HIGH OUTPUT LED					
0" REGRESS & ASLMD 681.4 LPF		0" REGRESS & ASLHD 498.2 LPF				0" REGRESS & ASLMD 908.5 LPF		0" REGRESS & ASLHD 664.3 LPF			
1" REGRESS & ASLMD 637.9 LPF		1" REGRESS & ASLHD 481.5 LPF				1" REGRESS & ASLMD 850.6 LPF		1" REGRESS & ASLHD 642 LPF			
2" REGRESS & ASLMD 593.8 LPF		2" REGRESS & ASLHD 464.5 LPF				2" REGRESS & ASLMD 791.8 LPF		2" REGRESS & ASLHD 619.3 LPF			
3" REGRESS & ASLMD 549.7 LPF		3" REGRESS & ASLHD 447.5 LPF				3" REGRESS & ASLMD 732.9 LPF		3" REGRESS & ASLHD 596.6 LPF			
CCT	2700 K	3000 K	3500 K*	4000 K	5000 K	CCT	2700 K	3000 K	3500 K*	4000 K	5000 K
WATTS / FT.	6.3	5.9	5.8	5.7	5.4	WATTS / FT.	8.6	8.2	8	7.8	7.4
<small>* IES FILES WERE CREATED USING 3500 K DIODES @ 80+ CRI. WATTAGE IS MULTIPLIED BY 1.06 FOR 2700 K, 1.02 FOR 3000 K, .98 FOR 4000 K AND .93 FOR 5000 K DIODES TO MAINTAIN THE SAME DELIVERED LUMENS THROUGHOUT ALL COLOR TEMPERATURES. FOR 90+ CRI, INCREASE WATTAGE BY 14.5%. SEE ADDENDUM FOR CUSTOM PROGRAMMING.</small>											

Construction

Housing: I.C. rated. ARRA, RoHS, REACH and Prop 65 compliant. Extruded aluminum body 6" wide x nominal 3.6" high, 6063T5, 0.070" min thickness. Each housing is 12' max unless longer housings are pre-coordinated with the factory to reduce joints and installation labor. Fixtures are built per approved factory drawings and tested as a complete system at the factory. Continuous runs and [patterns](#) are ordered, built and shipped with a single item #. Fixtures ordered as individuals are not designed to be joined together in the field. **Chicago Plenum** compliant construction (option code **CP**) does not exclude GAMMALUX **EZ-TELE™** capability.

Joiner System: Automatic alignment, no loose parts, one tool to tighten factory installed bolts for hairline seam. No light leaks.

Lamping: Patterns are fully illuminated. Runs ordered as Verify In Field (Length Option **VIF**) will be built to the exact dimension shown on signature-approved shop drawings. Runs ordered in Nominal Length (Option **N**) may be factory-adjusted to accommodate standard mounting positions or grid centers. GAMMALUX **EZ-TELE™** (LED/Housing Option **EZT**) allows for up to 6" field adjustability above and below the ordered run length with complete illumination throughout (see page 15). Factory drawings will show all dimensions of mounting and power feed locations. GAMMALUX **EZ-TELE™** runs built to less than 5' require remote driver installation - consult factory.

Mounting: Shall be perimeter mounted to wall via Adjustable Wall Bracket (**A**) and recessed into a grid or hard ceiling with up to 3" regress. Power feed is accomplished through knockouts in housing. Fixtures can be ganged together mechanically and electrically in continuous rows. Fixtures surrounded by grid should be ordered in Nominal length (Length Option **N**).

Specifications (continued)

Optical

Reflectors: Shall be formed diffuse high reflectance aluminum.

Acrylic Satin Lens, Medium Diffuse: Snap-in. Shall be 100% DR acrylic (**ASLMD**).

Acrylic Satin Lens, Heavy Diffuse: Snap-in. Shall be 100% DR acrylic (**ASLHD**). See lens images on photometric pages.

Finish

High solids aliphatic two component polyurethane high (**H**) or semi-gloss (**SG**), avg. thickness of 2 mils. Antimicrobial paint option (code **A**).



Packing and Shipping

Fixtures built for continuous rows and patterns are given a specific location identifier, clearly identified on factory layout drawings, the fixture's ID Label, protective wrapping and on each end of fixture carton. Shipping pallets are built with 2" clearance, extending beyond the length and width of cartons, providing shipping protection.

Approx. weight of 4' module is 10 lbs. including carton. Weight of pallet and supplemental packing materials not factored in.

Instructions

Click [here](#) for written instructions and videos.

**Photometric Reports for
STANDARD OUTPUT FIXTURES**

0" REGRESS, ASLMD (MEDIUM DIFFUSE) AND 3500K LEDs @ 80+ CRI

IESNA: LM-63-2002
ISSUEDATE: 07/13/2016
TEST: 1265806, SO, 6", 57452, PREVALED
TESTLAB: UL VERIFICATION SVCS, INC.
MANUFAC: GAMMALUX LTG SYS
LUMCAT: GPD6SL358GFROASLMD
LAMPS: 192 WHITE LEDs

MAX. UGR (NO WALL) 24
EFFICACY (TOTAL): 97 LPW
DISTRIBUTION % UP: 0%
DISTRIBUTION % DN: 100% (565.1 LPF)
CIE CLASSIFICATION: DIRECT

LUMINOUS OPENING: RECTANGULAR
WIDTH: 6 in.
LENGTH: 48.5 in.

INPUT WATTS: 23.31 per 4'

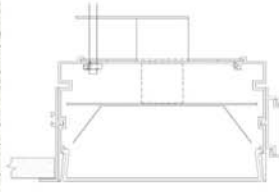

Acrylic Satin Lens,
Medium Diffuse
(ASLMD)

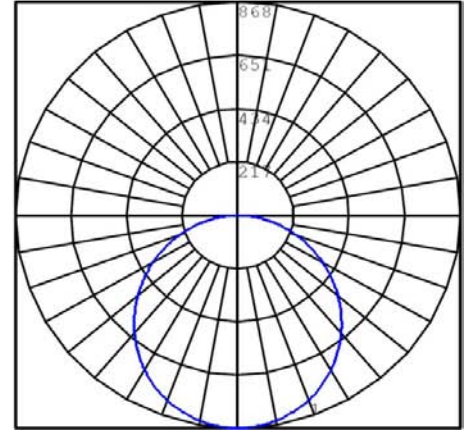

0" REGRESS, ASLHD (HEAVY DIFFUSE) AND 3500K LEDs @ 80+ CRI

IESNA: LM-63-2002
ISSUEDATE: 07/13/2016
TEST: 1265806, HD, SO, 6", 57452, PREVALED
TESTLAB: UL VERIFICATION SVCS, INC.
MANUFAC: GAMMALUX LTG SYS
LUMCAT: GPD6SL358GFROASLHD
LAMPS: 192 WHITE LEDs

MAX. UGR (NO WALL) 23.1
EFFICACY (TOTAL): 73.7 LPW
DISTRIBUTION % UP: 0%
DISTRIBUTION % DN: 100% (429.5 LPF)
CIE CLASSIFICATION: DIRECT

LUMINOUS OPENING: RECTANGULAR
WIDTH: 6 in.
LENGTH: 48.5 in.

INPUT WATTS: 23.31 per 4'

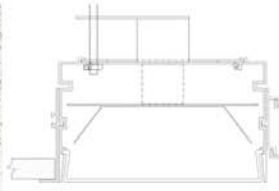

Acrylic Satin Lens,
Heavy Diffuse
(ASLHD)

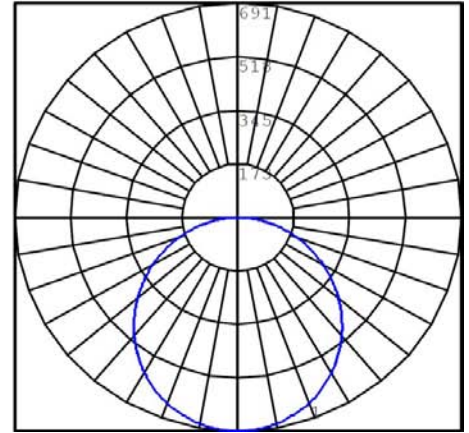

SEE NEXT PAGE FOR STANDARD OUTPUT FIXTURES WITH 1" REGRESS

**Photometric Reports for
STANDARD OUTPUT FIXTURES**

1" REGRESS, ASLMD (MEDIUM DIFFUSE) AND 3500K LEDs @ 80+ CRI

IESNA: LM-63-2002
ISSUEDATE: 8/14/2018
TEST: 13682237.03, SO, GFR1, PREVALED
TESTLAB: UL VERIFICATION SVCS, INC.
MANUFAC: GAMMALUX LTG SYS
LUMCAT: GPD6SL358GFR1ASLMD
LAMPS: 192 WHITE LEDs

MAX. UGR (NO WALL) 28.6
EFFICACY (TOTAL): 96.1 LPW
DISTRIBUTION % UP: 0%
DISTRIBUTION % DN: 100% (559.8 LPF)
CIE CLASSIFICATION: DIRECT

LUMINOUS OPENING: RECTANGULAR
WIDTH: 6 in.
LENGTH: 48.5 in.

INPUT WATTS: 23.31 per 4'

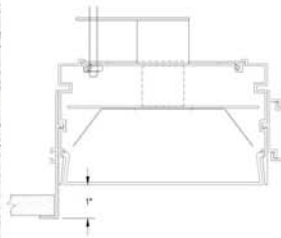

Acrylic Satin Lens,
Medium Diffuse
(ASLMD)

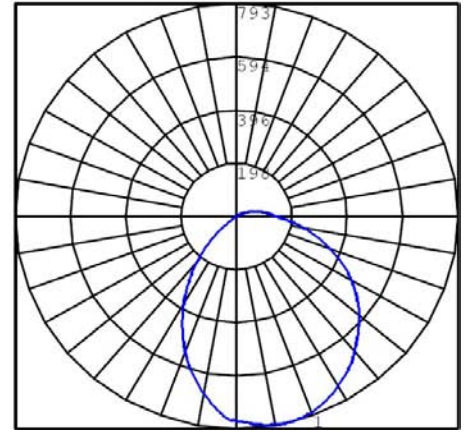

1" REGRESS, ASLHD (HEAVY DIFFUSE) AND 3500K LEDs @ 80+ CRI

IESNA: LM-63-2002
ISSUEDATE: 8/14/2018
TEST: 13682237.03, SO, HD, GFR1, PREVALED
TESTLAB: UL VERIFICATION SVCS, INC.
MANUFAC: GAMMALUX LTG SYS
LUMCAT: GPD6SL358GFR1ASLHD
LAMPS: 192 WHITE LEDs

MAX. UGR (NO WALL) 27.7
EFFICACY (TOTAL): 73 LPW
DISTRIBUTION % UP: 0%
DISTRIBUTION % DN: 100% (425.4 LPF)
CIE CLASSIFICATION: DIRECT

LUMINOUS OPENING: RECTANGULAR
WIDTH: 6 in.
LENGTH: 48.5 in.

INPUT WATTS: 23.31 per 4'

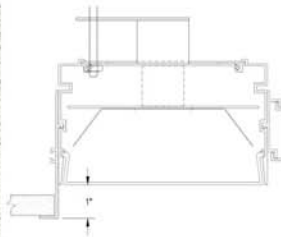

Acrylic Satin Lens,
Heavy Diffuse
(ASLHD)

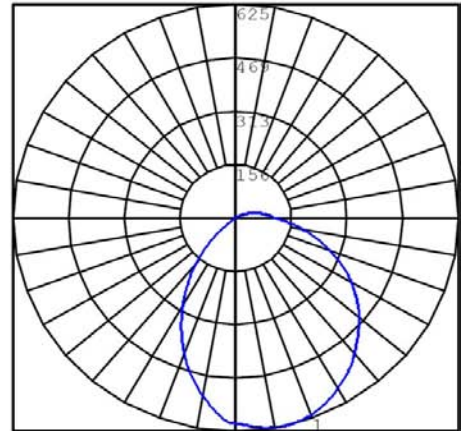

SEE NEXT PAGE FOR STANDARD OUTPUT FIXTURES WITH 2" REGRESS

**Photometric Reports for
STANDARD OUTPUT FIXTURES**

2" REGRESS, ASLMD (MEDIUM DIFFUSE) AND 3500K LEDs @ 80+ CRI

IESNA: LM-63-2002
ISSUEDATE: 8/14/2018
TEST: 13682237.03 MOD TO SO, PREVALED
TESTLAB: UL VERIFICATION SVCS, INC.
MANUFAC: GAMMALUX LTG SYS
LUMCAT: GPD6SL358GFR2ASLMD
LAMPS: 192 WHITE LEDs

MAX. UGR (NO WALL) 29.5
EFFICACY (TOTAL): 95.3 LPW
DISTRIBUTION % UP: 0%
DISTRIBUTION % DN: 100% (555.4 LPF)
CIE CLASSIFICATION: DIRECT

LUMINOUS OPENING: RECTANGULAR
WIDTH: 6 in.
LENGTH: 48.5 in.

INPUT WATTS: 23.31 per 4'

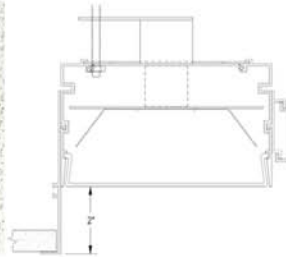

Acrylic Satin Lens,
Medium Diffuse
(ASLMD)

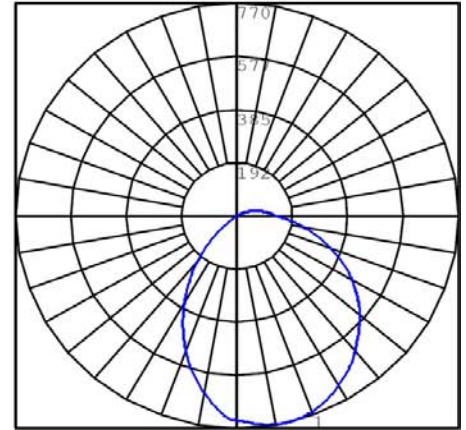

2" REGRESS, ASLHD (HEAVY DIFFUSE) AND 3500K LEDs @ 80+ CRI

IESNA: LM-63-2002
ISSUEDATE: 8/14/2018
TEST: 13682237.03 MOD SO, HD, PREVALED
TESTLAB: UL VERIFICATION SVCS, INC.
MANUFAC: GAMMALUX LTG SYS
LUMCAT: GPD6SL358GFR2ASLHD
LAMPS: 192 WHITE LEDs

MAX. UGR (NO WALL) 28.5
EFFICACY (TOTAL): 72.4 LPW
DISTRIBUTION % UP: 0%
DISTRIBUTION % DN: 100% (422.2 LPF)
CIE CLASSIFICATION: DIRECT

LUMINOUS OPENING: RECTANGULAR
WIDTH: 6 in.
LENGTH: 48.5 in.

INPUT WATTS: 23.31 per 4'

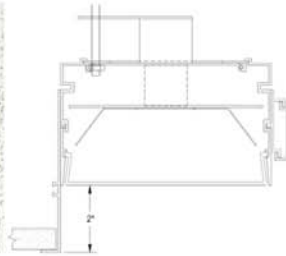

Acrylic Satin Lens,
Heavy Diffuse
(ASLHD)

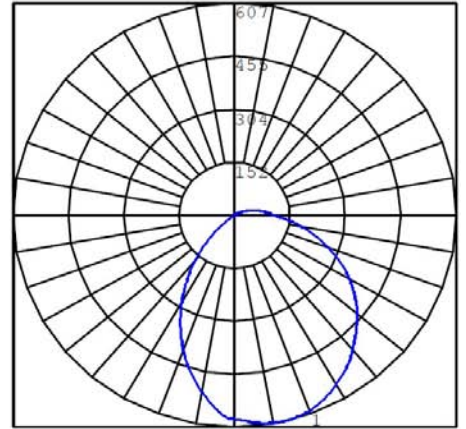

SEE NEXT PAGE FOR STANDARD OUTPUT FIXTURES WITH 3" REGRESS

**Photometric Reports for
STANDARD OUTPUT FIXTURES**

3" REGRESS, ASLMD (MEDIUM DIFFUSE) AND 3500K LEDs @ 80+ CRI

IESNA: LM-63-2002
ISSUEDATE: 01/26/2021
TEST: 13682237.06 MOD TO SO, PREVALED
TESTLAB: UL VERIFICATION SVCS, INC.
MANUFAC: GAMMALUX LTG SYS
LUMCAT: GPD6SL358GFR3ASLMD
LAMPS: 192 WHITE LEDs

MAX. UGR (NO WALL) 26.1
EFFICACY (TOTAL): 92.3 LPW
DISTRIBUTION % UP: 0%
DISTRIBUTION % DN: 100% (549.7 LPF)
CIE CLASSIFICATION: DIRECT

LUMINOUS OPENING: RECTANGULAR
WIDTH: 6 in.
LENGTH: 48 in.

INPUT WATTS: 23.31 per 4'

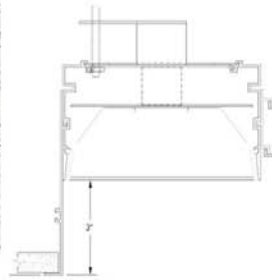

Acrylic Satin Lens,
Medium Diffuse
(ASLMD)

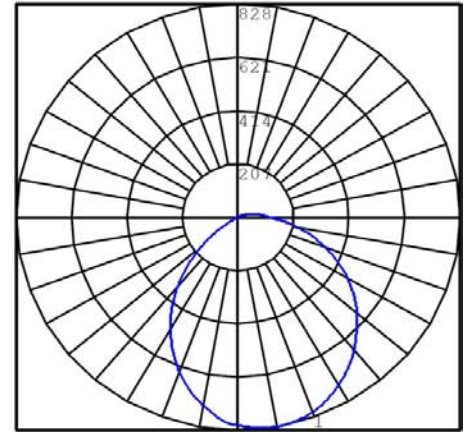

3" REGRESS, ASLHD (HEAVY DIFFUSE) AND 3500K LEDs @ 80+ CRI

IESNA: LM-63-2002
ISSUEDATE: 01/26/2021
TEST: 13682237.06 MOD SO, HD, PREVALED
TESTLAB: UL VERIFICATION SVCS, INC.
MANUFAC: GAMMALUX LTG SYS
LUMCAT: GPD6SL358GFR3ASLHD
LAMPS: 192 WHITE LEDs

MAX. UGR (NO WALL) 25.4
EFFICACY (TOTAL): 76.8 LPW
DISTRIBUTION % UP: 0%
DISTRIBUTION % DN: 100% (447.4 LPF)
CIE CLASSIFICATION: DIRECT

LUMINOUS OPENING: RECTANGULAR
WIDTH: 6 in.
LENGTH: 48 in.

INPUT WATTS: 23.31 per 4'



Acrylic Satin Lens,
Heavy Diffuse
(ASLHD)

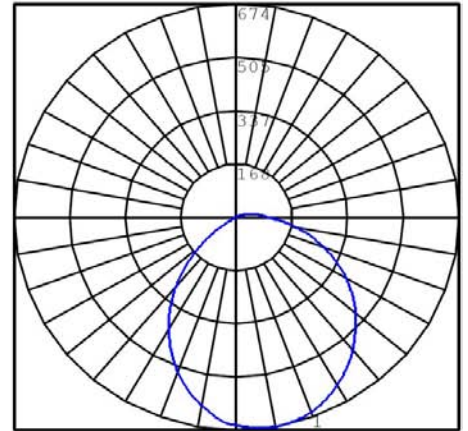

**Photometric Reports for
HIGH OUTPUT FIXTURES**

0" REGRESS, ASLMD (MEDIUM DIFFUSE) AND 3500K LEDs @ 80+ CRI

IESNA: LM-63-2002
ISSUEDATE: 07/13/2016
TEST: 1265806, 6", 57452, PREVALED
TESTLAB: UL VERIFICATION SVCS, INC.
MANUFAC: GAMMALUX LTG SYS
LUMCAT: GPD6HL358GFR0ASLMD
LAMPS: 192 WHITE LEDs

MAX. UGR (NO WALL) 25
EFFICACY (TOTAL): 93.8 LPW
DISTRIBUTION % UP: 0%
DISTRIBUTION % DN: 100% (753.4 LPF)
CIE CLASSIFICATION: DIRECT

LUMINOUS OPENING: RECTANGULAR
WIDTH: 6 in.
LENGTH: 48.5 in.

INPUT WATTS: 32.12 per 4'

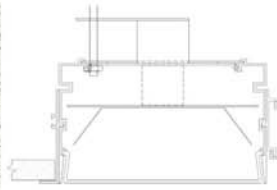

Acrylic Satin Lens,
Medium Diffuse
(ASLMD)

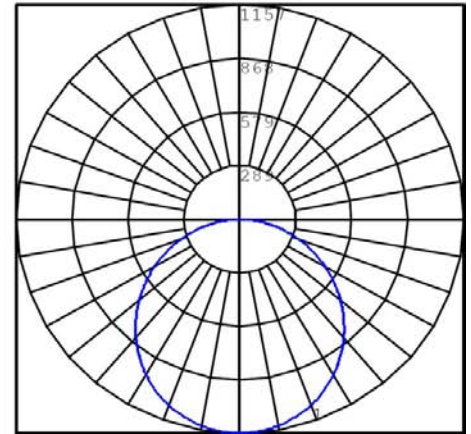

0" REGRESS, ASLHD (HEAVY DIFFUSE) AND 3500K LEDs @ 80+ CRI

IESNA: LM-63-2002
ISSUEDATE: 07/13/2016
TEST: 1265806, HD, 6", 57452, PREVALED
TESTLAB: UL VERIFICATION SVCS, INC.
MANUFAC: GAMMALUX LTG SYS
LUMCAT: GPD6HL358GFR0ASLHD
LAMPS: 192 WHITE LEDs

MAX. UGR (NO WALL) 24.1
EFFICACY (TOTAL): 71.3 LPW
DISTRIBUTION % UP: 0%
DISTRIBUTION % DN: 100% (572.6 LPF)
CIE CLASSIFICATION: DIRECT

LUMINOUS OPENING: RECTANGULAR
WIDTH: 6 in.
LENGTH: 48.5 in.

INPUT WATTS: 32.12 per 4'

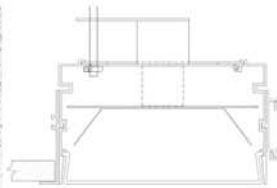

Acrylic Satin Lens,
Heavy Diffuse
(ASLHD)

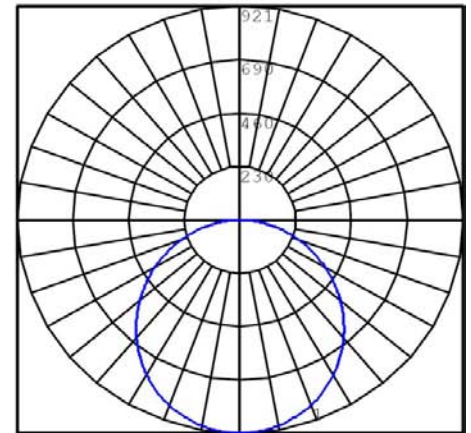

SEE NEXT PAGE FOR HIGH OUTPUT FIXTURES WITH 1" REGRESS

**Photometric Reports for
HIGH OUTPUT FIXTURES**

1" REGRESS, ASLMD (MEDIUM DIFFUSE) AND 3500K LEDs @ 80+ CRI

IESNA: LM-63-2002
ISSUEDATE: 8/14/2018
TEST: 13682237.03, GFR1, PREVALED
TESTLAB: UL VERIFICATION SVCS, INC.
MANUFAC: GAMMALUX LTG SYS
LUMCAT: GPD6HL358GFR1ASLMD
LAMPS: 192 WHITE LEDs

MAX. UGR (NO WALL) 29.6
EFFICACY (TOTAL): 92.9 LPW
DISTRIBUTION % UP: 0%
DISTRIBUTION % DN: 100% (746.3 LPF)
CIE CLASSIFICATION: DIRECT

LUMINOUS OPENING: RECTANGULAR
WIDTH: 6 in.
LENGTH: 48.5 in.

INPUT WATTS: 32.12 per 4'

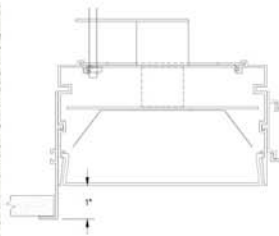

Acrylic Satin Lens,
Medium Diffuse
(ASLMD)

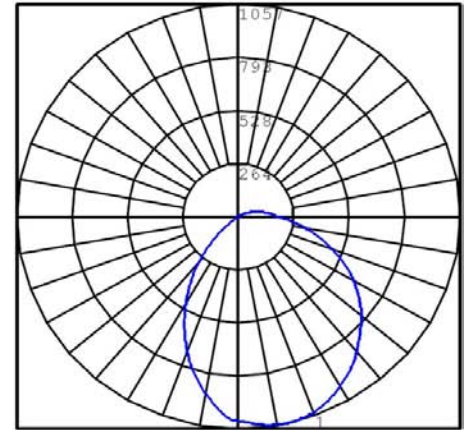

1" REGRESS, ASLHD (HEAVY DIFFUSE) AND 3500K LEDs @ 80+ CRI

IESNA: LM-63-2002
ISSUEDATE: 8/14/2018
TEST: 13682237.03 MOD HD, GFR1, PREVALED
TESTLAB: UL VERIFICATION SVCS, INC.
MANUFAC: GAMMALUX LTG SYS
LUMCAT: GPD6HL358GFR1ASLHD
LAMPS: 192 WHITE LEDs

MAX. UGR (NO WALL) 28.7
EFFICACY (TOTAL): 70.6 LPW
DISTRIBUTION % UP: 0%
DISTRIBUTION % DN: 100% (567.2 LPF)
CIE CLASSIFICATION: DIRECT

LUMINOUS OPENING: RECTANGULAR
WIDTH: 6 in.
LENGTH: 48.5 in.

INPUT WATTS: 32.12 per 4'

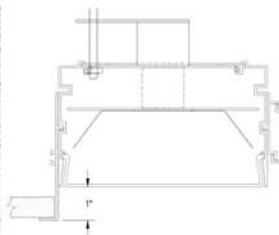

Acrylic Satin Lens,
Heavy Diffuse
(ASLHD)

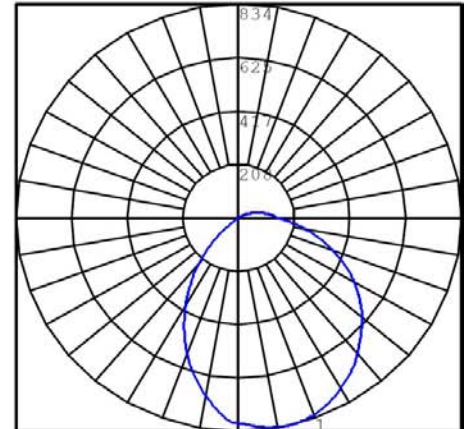

SEE NEXT PAGE FOR HIGH OUTPUT FIXTURES WITH 2" REGRESS

**Photometric Reports for
HIGH OUTPUT FIXTURES**

2" REGRESS, ASLMD (MEDIUM DIFFUSE) AND 3500K LEDs @ 80+ CRI

IESNA: LM-63-2002
ISSUEDATE: 8/14/2018
TEST: 13682237.03, PREVALED
TESTLAB: UL VERIFICATION SVCS, INC.
MANUFAC: GAMMALUX LTG SYS
LUMCAT: GPD6HL358GFR2ASLMD
LAMPS: 192 WHITE LEDs

MAX. UGR (NO WALL) 30.5
EFFICACY (TOTAL): 92.2 LPW
DISTRIBUTION % UP: 0%
DISTRIBUTION % DN: 100% (740.5 LPF)
CIE CLASSIFICATION: DIRECT

LUMINOUS OPENING: RECTANGULAR
WIDTH: 6 in.
LENGTH: 48.5 in.

INPUT WATTS: 32.12 per 4'

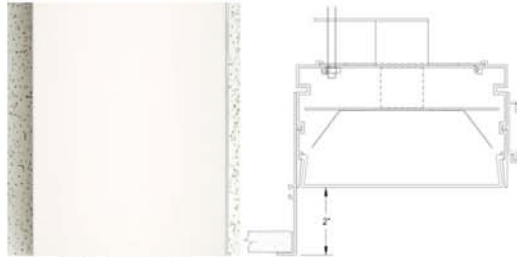

Acrylic Satin Lens,
Medium Diffuse
(ASLMD)

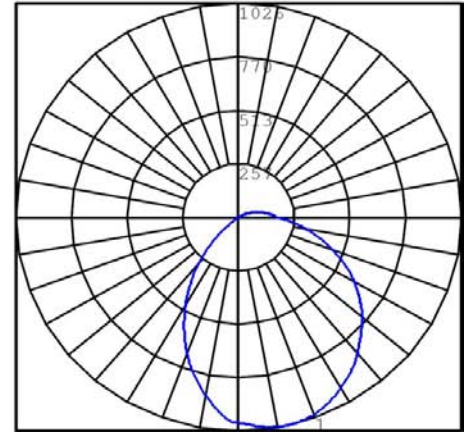

2" REGRESS, ASLHD (HEAVY DIFFUSE) AND 3500K LEDs @ 80+ CRI

IESNA: LM-63-2002
ISSUEDATE: 8/14/2018
TEST: 13682237.03, HD, PREVALED
TESTLAB: UL VERIFICATION SVCS, INC.
MANUFAC: GAMMALUX LTG SYS
LUMCAT: GPD6HL358GFR2ASLHD
LAMPS: 192 WHITE LEDs

MAX. UGR (NO WALL) 29.5
EFFICACY (TOTAL): 70.1 LPW
DISTRIBUTION % UP: 0%
DISTRIBUTION % DN: 100% (562.9 LPF)
CIE CLASSIFICATION: DIRECT

LUMINOUS OPENING: RECTANGULAR
WIDTH: 6 in.
LENGTH: 48.5 in.

INPUT WATTS: 32.12 per 4'

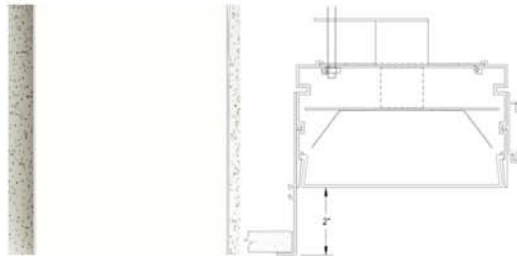

Acrylic Satin Lens,
Heavy Diffuse
(ASLHD)

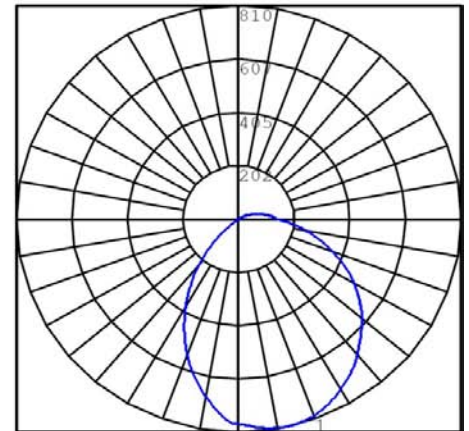

SEE NEXT PAGE FOR HIGH OUTPUT FIXTURES WITH 3" REGRESS

**Photometric Reports for
HIGH OUTPUT FIXTURES**

3" REGRESS, ASLMD (MEDIUM DIFFUSE) AND 3500K LEDs @ 80+ CRI

IESNA: LM-63-2002
ISSUEDATE: 01/26/2021
TEST: 13682237.06, PREVALED
TESTLAB: UL VERIFICATION SVCS, INC.
MANUFAC: GAMMALUX LTG SYS
LUMCAT: GPD6HL358GFR3ASLMD
LAMPS: 192 WHITE LEDs

MAX. UGR (NO WALL) 27.1
EFFICACY (TOTAL): 91.3 LPW
DISTRIBUTION % UP: 0%
DISTRIBUTION % DN: 100% (732.9 LPF)
CIE CLASSIFICATION: DIRECT

LUMINOUS OPENING: RECTANGULAR
WIDTH: 6 in.
LENGTH: 48 in.

INPUT WATTS: 32.12 per 4'



Acrylic Satin Lens,
Medium Diffuse
(ASLMD)

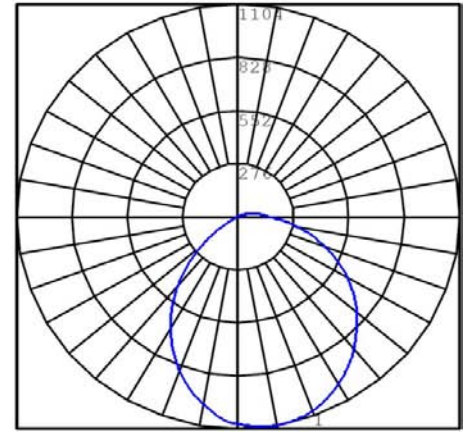

3" REGRESS, ASLHD (HEAVY DIFFUSE) AND 3500K LEDs @ 80+ CRI

IESNA: LM-63-2002
ISSUEDATE: 01/26/2021
TEST: 13682237.06 MOD TO HD, PREVALED
TESTLAB: UL VERIFICATION SVCS, INC.
MANUFAC: GAMMALUX LTG SYS
LUMCAT: GPD6HL358GFR3ASLHD
LAMPS: 192 WHITE LEDs

MAX. UGR (NO WALL) 26.4
EFFICACY (TOTAL): 74.3 LPW
DISTRIBUTION % UP: 0%
DISTRIBUTION % DN: 100% (596.6 LPF)
CIE CLASSIFICATION: DIRECT

LUMINOUS OPENING: RECTANGULAR
WIDTH: 6 in.
LENGTH: 48 in.

INPUT WATTS: 32.12 per 4'



Acrylic Satin Lens,
Heavy Diffuse
(ASLHD)

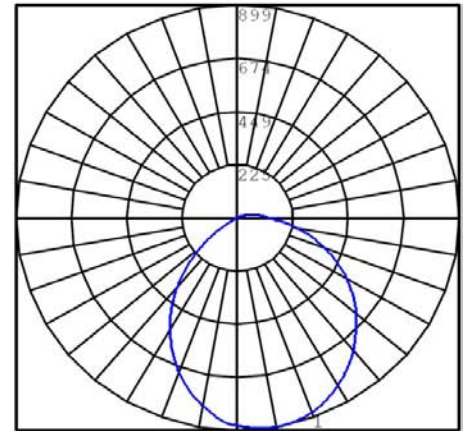

Mounting Details

Factory Drawings: Fully dimensioned factory drawings will be provided for approval or record. Click [here](#) for complete written instructions and videos.

Perimeter Mount: Flanged (REC/A/GFR3 shown)

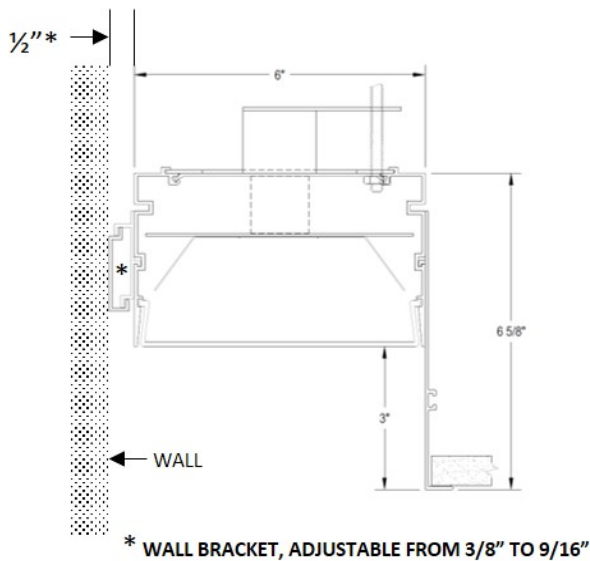

Installation Summary

1. Pre-install threaded rod and power at locations shown on Gammalux shop drawings.
2. Install wall bracket per shop drawings.
3. If using optional exterior rod support bracket, raise fixture into place and support on wall bracket, then apply nut on threaded rod and level fixture.
If NOT using optional exterior rod support bracket, remove LED array and backing plate from locations indicated inside fixture, raise fixture into place and support on wall bracket, then apply nut on threaded rod and level fixture. Trim threaded rod and reinstall LED backing plate and LED array.
4. Make electrical and control connections.
5. Join continuous runs and test fixtures.
6. Install ceiling.

Perimeter Mount: Mud-in (REC/A/GMR3 shown)

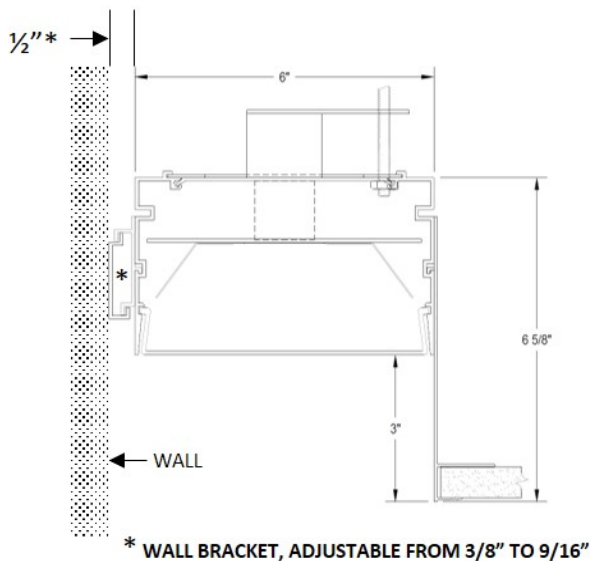

Installation Summary

1. Pre-install threaded rod and power at locations shown on Gammalux shop drawings.
2. Install wall bracket per shop drawings.
3. If using optional exterior rod support bracket, raise fixture into place and support on wall bracket, then apply nut on threaded rod and level fixture.
If NOT using optional exterior rod support bracket, remove LED array and backing plate from locations indicated inside fixture, raise fixture into place and support on wall bracket, then apply nut on threaded rod and level fixture. Trim threaded rod and reinstall LED backing plate and LED array.
4. Make electrical and control connections.
5. Join continuous runs and test fixtures.
6. Insert gyp between upper and lower flanges, secure to upper flange with self-tapping drywall screws.
7. Apply joint tape and joint compound on lower flange and finish per architectural instructions.

Gammalux Lighting Systems reserves the right to change the details of fixture design and construction at any time.

Mounting Details

Factory Drawings:

Mounting style from page 1: REC/A/GFR

Fixture is recessed above the ceiling line and IS NOT touching a side wall (**REC**). The fixture attaches to back wall via Gammalux-provided Wall Rail which is mounted above the ceiling line per approved shop drawings. The fixture bottom features a 1" flange (**GFR**) on three sides, allowing it to rest under the ceiling material.

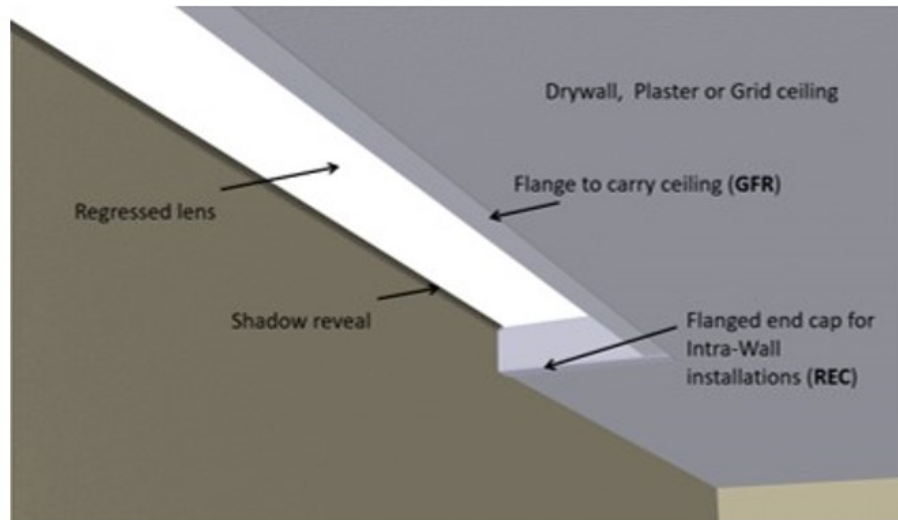

Mounting style from page 1: REC/A/GMR

Fixture is recessed above the ceiling line and IS NOT touching a side wall (**REC**). The fixture attaches to back wall via Gammalux-provided Wall Rail which is mounted above the ceiling line per approved shop drawings. The fixture bottom features a mud flange (**GMR**) on three sides, allowing it to be 'mudded' into the drywall or plaster ceiling.

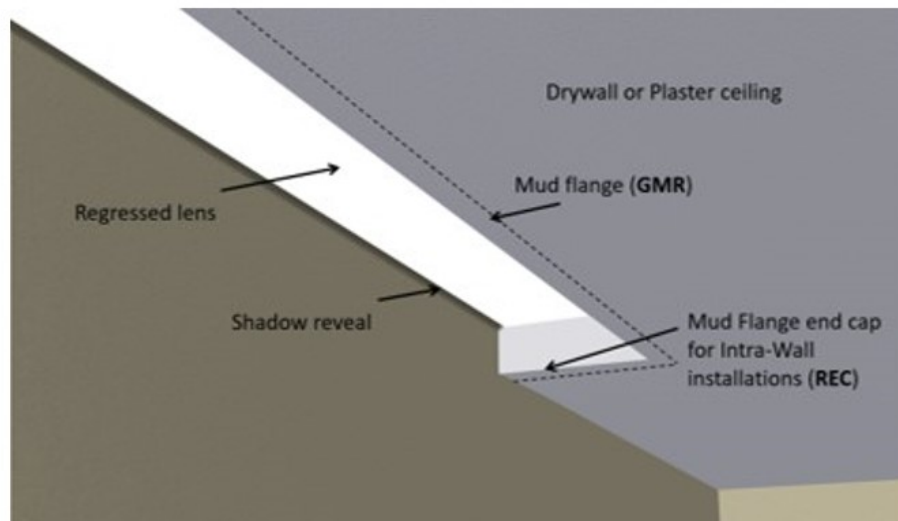

Gammalux Lighting Systems reserves the right to change the details of fixture design and construction at any time.

Mounting Details

Factory Drawings:

Mounting style from page 1: RECW/A/GFR

Fixture is recessed above the ceiling line and terminates at a side wall (**RECW**). The exposed portion of the side wall above the ceiling line should be finished to match the rest of the wall. The fixture attaches to back wall via Wall Rail which is mounted above the ceiling line per approved shop drawings. The fixture bottom features a 1" flange (**GFR**), allowing it to rest under the ceiling material.

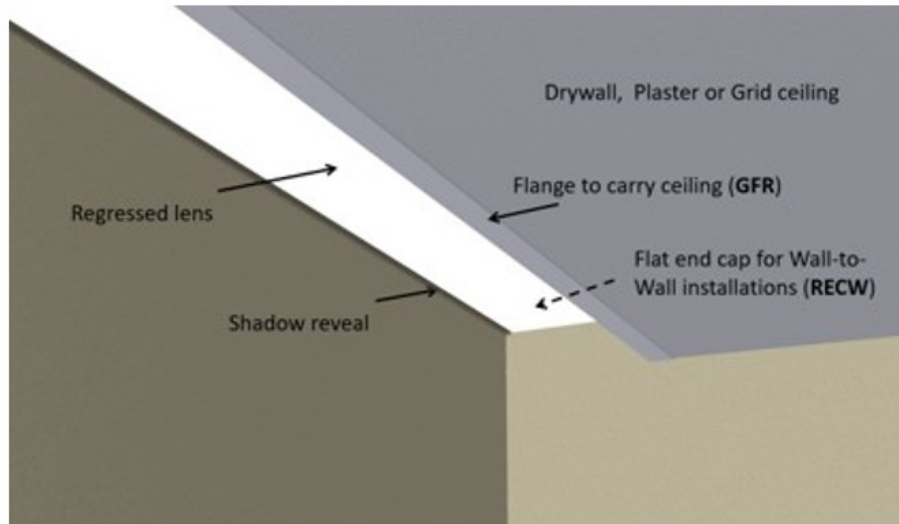

Mounting style from page 1: RECW/A/GMR

Fixture is recessed above the ceiling line and terminates at a side wall (**RECW**). The exposed portion of the side wall above the ceiling line should be finished to match the rest of the wall. The fixture attaches to back wall via Wall Rail which is mounted above the ceiling line per approved shop drawings. The fixture bottom features a mud flange (**GMR**), allowing it to be 'mudded' into the drywall or plaster ceiling.

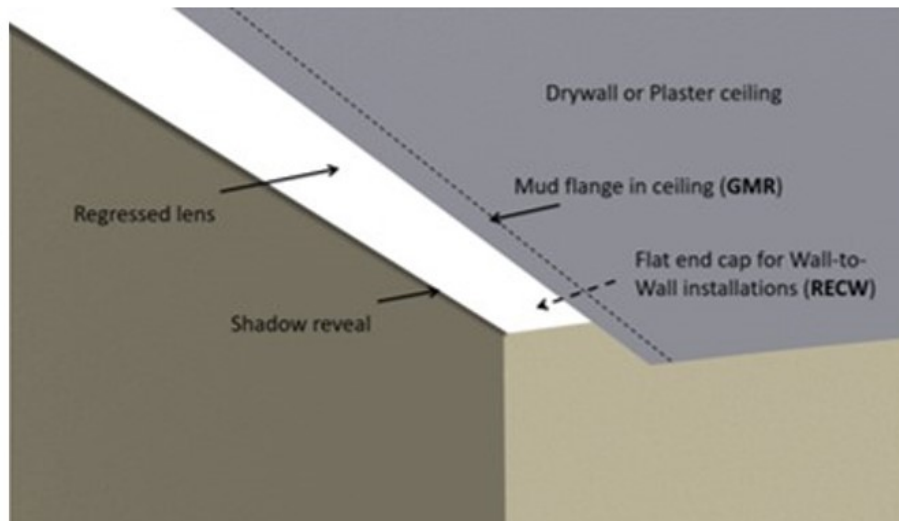

Gammalux Lighting Systems reserves the right to change the details of fixture design and construction at any time.

Custom Programmed Output

Custom Programmed Output can be specified to produce approximate Delivered Lumens per Foot, Percentage of High Output Value or Maximum Watts per Foot.

Delivered Lumens Per Foot

Gammalux deals only in delivered lumens per foot. When working to match or exceed a competitor product's Lumens Per Foot package, be sure you are looking at their Delivered (through the lens) lumens per foot, not their System (bare board) lumens per foot.

In the Gammalux item #, use **C** as the Output designator and add a fixture description stating the required Lumens Per Foot value (ie: if you need 600 lumens per foot delivered by the fixture, the line note would read "Program = 600 LPF").

Percentage of High Output Value

If the required delivered lumens per foot are not known, run lighting calculations using our High Output IES file and identify the percentage of increase or decrease required to produce the correct lighting in the space.

In the Gammalux item #, use **C** as the Output designator and add a fixture description stating the required percentage of decrease from our High Output value (ie: for 60% of our High Output value, the line note would read "Program = 60% of High Output").

Maximum Watts Per Foot

In the Gammalux item #, use **C** as the Output designator and add a fixture description stating the required Maximum Watts per Foot (ie: if you need the fixtures capped at a maximum of 7 watts per foot, the line note would read "Program = 7 WPF").

For all three methods, custom programming capability is currently 25-200% of our High Output value. For requirements outside of this range, consult factory.

Length Details

GAMMALUX EZ-TELE™ (LED/Housing option EZT)

This patented option is recommended when exact run lengths cannot be determined prior to product release or when flexibility is required. Additional manufacturing costs apply.

Factory drawings will be provided showing the run at the ordered length with field adjustability of up to 6" in either direction.

- GPD3 through GPD6: Minimum run length is 3', driver is integral.
- GPD1 and GPD2: Minimum run with integral driver is 5'. Minimum with remote driver is 3'.
 - If remote driver is needed, add "/R" after driver code (ex. ZTV10/R)

Contact us at Gammalux to discuss your project and let us help you determine the best way to specify and order your fixtures for a beautiful installation that meets *your design intent*.

Nominal Length (Length option N)

This option is recommended when GAMMALUX EZ-TELE™ is used or when meeting an exact dimension is not required.

Verify in Field (Length option VIF)

This option is recommended when GAMMALUX EZ-TELE™ is not used, but fixtures must still be built to an exact dimension for patterns, wall-to-wall installations or to match an architectural feature. Field verification is required prior to release to production.

GAMMALUX EZ-TELE™

Illuminated Corners with Custom-angle capability

Extruded aluminum housings for pristine alignment and fit

Up to 3" Lens Regress

Mud flange or cover flange for gyp or grid

GPD

- Six Aperture Sizes
- Competitive project pricing

GAMMALUX EZ-TELE™ FOR SIMPLIFIED PERIMETER WALL SLOT INSTALLATIONS*** =

***U.S. PATENT No. 11,384,923

- GPD IS DESIGNED FOR ACCELERATED CONSTRUCTION SCHEDULES
- JOURNEYMAN PRIMARY INSTALLATION & APPRENTICE FINAL TRIM OUT
- **FAST INSTALL**
- **LESS JOURNEYMAN LABOR REQUIRED**
- **CLEAN DESIGN**

"Specifying Gammalux perimeter lighting systems is essential for problem-free installations!"

Ordering Guide

Nominal Length (with EZT) or Verify In Field

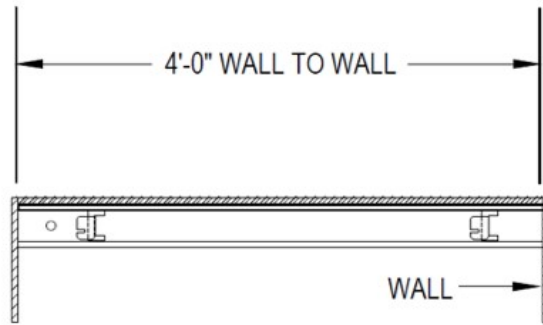
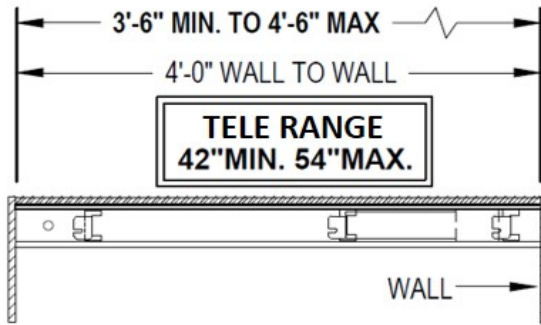

With GAMMALUX *EZ-TELE™*, the run or fixture has 6" of adjustability above and below the ordered (example 4') dimension. If the final dimension is within the fixture's adjustability, no field dimension is required.

If GAMMALUX *EZ-TELE™* is not selected, the run or fixture is built to the exact dimension provided and will have no field adjustability. The exact fixture dimension must be the signature approved (Verify In Field) to allow Release to Production.

Fixtures or runs ordered without GAMMALUX *EZ-TELE™* and in Nominal length will have no field adjustability and may be built slightly shorter or longer than the ordered length to accommodate standard components.

Intra-Wall (REC) or Wall-To-Wall (RECW)

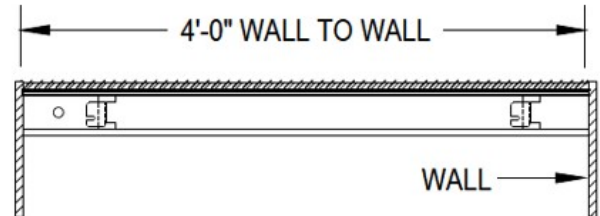
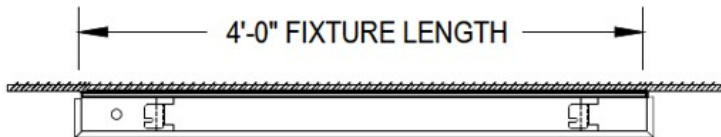

Neither end touches an adjacent wall. End caps have the same ceiling trim as the front of the fixture.

Each end touches an adjacent wall. End caps do not have a ceiling trim and terminate at the bottom of the fixture housing (see mounting detail illustrations).

RECW Variations

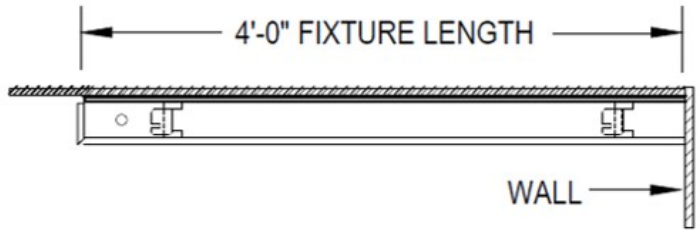
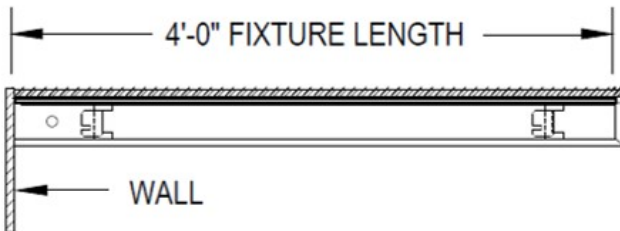

RECWL = only the left end of the fixture touches an adjacent wall. The other end will have the same ceiling trim as the front of the fixture.

RECWR = only the right end of the fixture touches an adjacent wall. The other end will have the same ceiling trim as the front of the fixture.

Approved Cut Release option

If offered for Approved Cut Release in the Gammalux factory quote, the product in the accompanying purchase order is authorized by the GC to be released to production without the need for factory drawings for approval.

I confirm that:

- all ordering options are clearly noted (highlighted, boxed, written in, etc.) on page 1 of this fixture cut sheet
- quoted leadtime begins upon Gammalux's confirmation that the P.O. and marked cut sheet match their quote.
- the order will be released to production and a "record only" drawing will be provided prior to product shipment
- changes after Gammalux's release to production will result in a minimum 25% change fee which increases as production progresses.

General Contractor _____

GC's authorized Signature (or stamp below) _____

Signatory's printed name _____