

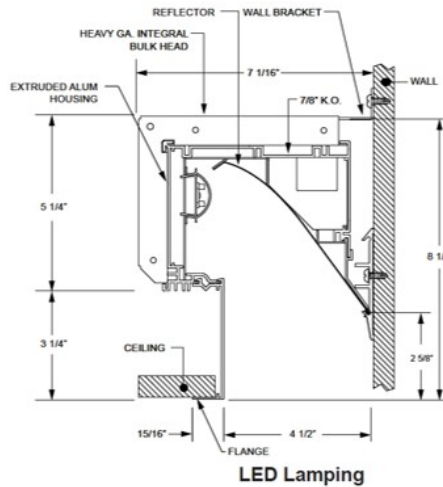

Click or scan QR code to view latest spec sheet



LED Lamping



Click photo to view product page
Page 1: Overview & Nomenclature
Pages 2-3: Specifications
Pages 4-5: Photometric Info / Downloads
Page 6: Mounting Details
Pages 8-11: Perimeter Series Options
Pages 12-13: Custom Programming

Revision Date: November 08, 2023
Gammalux Lighting Systems reserves the right to change details of fixture designs and construction at any time.

Product Overview (for complete specifications, see pages 2 & 3) *****NEW***** See last page for **APPROVED CUT RELEASE**.

Quick Ship: Most product options are shippable within 2-3 weeks! Check our **Quick Ship Guide** for details.

Construction: I.C. rated. ARRA, RoHS, REACH and Prop 65 compliant. Extruded aluminum housing for superior fit and finish. Runs and patterns have a single item # and can be built to field dims.

Unbroken Illumination: Continuous illumination in custom-length runs and patterns with illuminated corners.

Electrical: LED components by major manufacturers, may be upgraded in the field to increase energy efficiency. Fixtures can be fitted with specialty LED and control components (consult factory). Standard Output, High Output and Custom Output options available.

Optical: Reflectors are formed to provide asymmetric distribution.

Standard Nomenclature

Quick Ship Eligible
Most options 2-3 weeks

Manufacturer Gammalux	Output S Standard Output H High Output C Custom Output (see addendum page)	Driver ZTV10 0-10V Dim to 10% ZTV1 0-10V Dim to 1% For all options, see next page	Ceiling Interface GFR Gyp or grid w/ .5" cover flange GMR Gyp w/ mud flange	Paint Colors W White (See color chart for other colors) CCM Custom Color Match	Paint Finish H High Gloss SG Semi-Gloss
Aperture (nom) 4"	CRI** 8 for 80+ 9 for 90+	Voltage 120V, 277V, UNIV	Length Option N Nominal S Specific	Wall Interface PR Plaster Rail WF Wall Flange AT Adjustment Trim	
GPRA4N	SL358T	UNIV	ZTV10	4'N	RECW/PR/GMR
Lamp Barrier None	LED Arrangement Blank Run is built to field dimensions T Run includes optional telescoping end for field adjustment (pg 5)	Mounting REC Recessed intra-wall RECW*** Recessed wall-to-wall	Run or Pattern Specify total run length (i.e. 43' 5 1/8") For illuminated patterns, follow overall length or dimensions with L, T, X, U, RECT or SQ (i.e. 43' 5 1/8" RECT or 10' X 10' SQ). If overall length or dims are unknown, use TBD and follow with L, T, X, U, RECT or SQ (i.e. TBD RECT or TBD SQ). Consult factory for complex or multi-plane patterns.	Options BPE Battery Pack (4' section) DL UL Damp Label EMERG Emergency Ckt 2CKT Dual Circuiting SBO Sensor By Others#	
Distribution Ambient	Color Temp. (nom) 27 2700K 30 3000K 35 3500K 40 4000K 50 5000K RGB & RGBW, consult factory			Shielding OP Open DC Dust Cover, Clear	
Optic Location Regressed					WSG
Series Perimeter					

** 90+ CRI increases watts nom. 14.5%. # Sensor by Others (consult factory). *** Field dims. required.

Specifications (continued on next page)

Electrical

Output: Standard (S) and high (H) options deliver a pre-set lumen package (see chart below). Custom-programmed output (C) is specified as LPF, WPF or % of High Output (see Custom Programmed Output page).

Static Driver: eldoLED [Optotronic](#)* programmable driver, wired for static operation (DVR).

0-10V Dimming: eldoLED [Optotronic](#)* programmable driver, wired for 0-10v control and dimming to 10% (ZTV10) or to 1% (ZTV1).

Step Dimming: Generic step dimming driver, two hot inputs for 100% and 50% output (SD2).

DALI Dimming: Generic DALI driver with two loose control wires exiting fixture at power feed location (DALI).

Lutron Dimming: [Hi-Lume](#) dim to 1% EcoSystem with Soft-On, Fade-to-Black (LDE1).

White Emitter: Nichia 757G emitters* binned within 3 MacAdam ellipses in Osram or Gammalux proprietary array. 90+ CRI option with extended lead time (CRI code 9) results in nominal 14.5% drop in efficacy; increase calculated watts 14.5%.

Battery Pack: Bodine [BSL10T3](#)* (BPE). 4W max input, 10W initial output, delivers min. 27% of High Output value per 4' length.

LED System: 70% lumen output (L70) at max 85 degrees C calculated at >60k hours. Fixtures are shipped with anti-static gloves to minimize the risk of damage to LEDs during installation. [5 year limited warranty](#).

Sensors: Sensors are as specified, confirmed by Gammalux prior to factory quote. Examples are Enlighted [Micro Sensor](#), Lutron [Athena Wireles Node](#), Lutron [Vive](#), Wattstopper [FS-205](#).

Upgrade Capability: LED assemblies can be replaced in the future with the latest factory-provided and fully warranted components. On-board sensors, control interface devices and alternate LED components may be specified (consult factory). Fixtures bear UL & cUL Dry Location label. Damp Location label available (DL).

*Subject to availability; may be substituted by Gammalux. Components and specifications may be changed without notice.

LUMENS AND WATTS BY OUTPUT OPTION AND LED COLOR @ 80+ CRI*											
STANDARD OUTPUT LED						HIGH OUTPUT LED					
OPEN APERTURE (OP)						OPEN APERTURE (OP)					
DELIVERS: 556.1 LPF						DELIVERS: 737.7 LPF					
CCT	2700 K	3000 K	3500 K*	4000 K	5000 K	CCT	2700 K	3000 K	3500 K*	4000 K	5000 K
WATTS / FT.	6.3	5.9	5.8	5.7	5.4	WATTS / FT.	8.6	8.2	8	7.8	7.4
*IES FILES WERE CREATED USING 3500K DIODES @80+ CRI. WATTAGE IS MULTIPLIED BY 1.08 FOR 2700K, 1.02 FOR 3000K, .98 FOR 4000K AND .93 FOR 5000K DIODES TO MAINTAIN THE SAME DELIVERED LUMENS THROUGHOUT ALL COLOR TEMPERATURES. FOR 90+ CRI, INCREASE WATTAGE BY 14.5%. SEE ADDENDUM FOR CUSTOM PROGRAMMING.											

Construction

Housing: I.C. rated. ARRA, RoHS, REACH and Prop 65 compliant. Extruded aluminum body components and trim, 6063T5, 0.090" minimum thickness. Each housing is 8' max unless longer housings are pre-coordinated with the factory to reduce joints and installation labor. Fixtures are built per approved factory drawings and tested as a complete system at the factory. Continuous runs and [patterns](#) are ordered, built and shipped with a single item #. Fixtures ordered as individuals are not designed to be joined together in the field.

Joiner System: Automatic alignment, no loose parts, factory-supplied bolts are used to join fixture bulkheads in continuous runs. No light leaks.

Lamping: Patterns are fully illuminated. Runs ordered in Specific Length (Length Option S) will be built to the exact dimension shown on signature-approved shop drawings. Runs ordered in Nominal Length (Option N) may be factory-adjusted to accomodate standard mounting positions or grid centers. Factory drawings will show all dimensions of mounting and power feed locations. Fixtures built to less than 4' may require remote driver installation - consult factory.

Mounting: Shall be perimeter mounted to wall via Plaster Rail (PR), Wall Flange (WF) or Adjustment Trim (AT) and recessed into a ceiling system before the ceiling is finished.

Specifications (continued)

Optical

Reflectors: Shall be asymmetric formed diffuse white painted aluminum.

Finish

Acid etched or clear anodized housing electrostatically sprayed with high solids aliphatic two component polyurethane high (**H**) or semi-gloss (**SG**) to an avg. thickness of 2 mils. Custom finish, consult factory. Wood Finishes, back page.



Packing and Shipping

Fixtures built for continuous rows and patterns are given a specific location identifier, clearly identified on factory layout drawings, the fixture's ID Label, protective wrapping and on each end of fixture carton. Shipping pallets are built with 2" clearance, extending beyond the length and width of cartons, providing shipping protection.

Approx. weight of 4' module is 21 lbs. including carton. Weight of pallet and supplemental packing materials not factored in.

Photometric Reports for
STANDARD OUTPUT FIXTURES

FIXTURE USES OPEN OPTIC AND 3500K LEDs @ 80+ CRI

IESNA: LM-63-2002
ISSUEDATE: 10/31/2014
TEST: 1 MOD TO 2014 COMPONENTS, 57452
TESTLAB: UL VERIFICATION SVCS, INC.
MANUFAC: GAMMALUX LTG SYS
LUMCAT: GPRA4N1SL3580P
LAMPS: 144 WHITE LEDs

EFFICACY (TOTAL): 102.17 LPW
DISTRIBUTION % UP: 0%
DISTRIBUTION % DN: 100% (555.3 LPF)
CIE CLASSIFICATION: DIRECT

LUMINOUS OPENING: RECTANGULAR
WIDTH: 4 in.
LENGTH: 48 in.
HEIGHT: .52 ft
INPUT WATTS: 21.74 per 4'

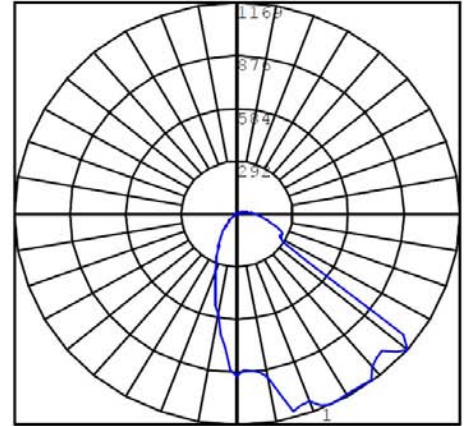
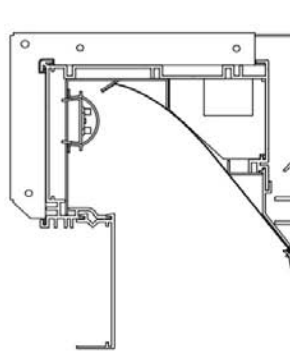

**Photometric Reports for
HIGH OUTPUT FIXTURES**

FIXTURE USES OPEN OPTIC AND 3500K LEDs @ 80+ CRI

IESNA: LM-63-2002
ISSUEDATE: 10/31/2014
TEST: 1 MOD TO 2014 COMPONENTS, 57452
TESTLAB: UL VERIFICATION SVCS, INC.
MANUFAC: GAMMALUX LTG SYS
LUMCAT: GPRA4N1HL3580P
LAMPS: 144 WHITE LEDs

EFFICACY (TOTAL): 96.49 LPW
DISTRIBUTION % UP: 0%
DISTRIBUTION % DN: 100% (737.9 LPF)
CIE CLASSIFICATION: DIRECT

LUMINOUS OPENING: RECTANGULAR
WIDTH: 4 in.
LENGTH: 48 in.
HEIGHT: .52 ft
INPUT WATTS: 30.59 per 4'

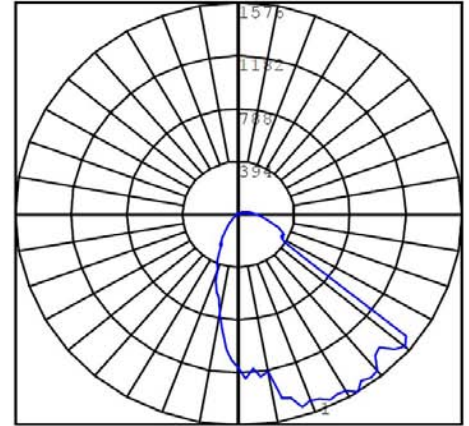
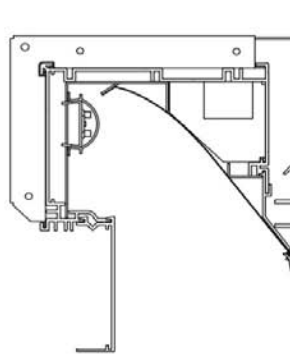

Mounting Details

Factory Drawings: Fully dimensioned factory drawings will be provided upon receipt of purchase order.

A The Ambient illumination optic is designed to bounce light off the top of the wall, back out into occupied space. The reflector material is white high reflectance, low gloss painted. Reflectors are pre-installed in 4' increments. For the best ambient illumination effect, use no lamp barrier in the fixture.

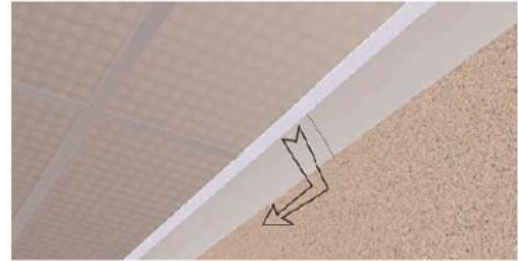

G The Grazing illumination optic is designed to drive light directly down through the fixture aperture. The reflector material is high reflectance, semi specular aluminum. Reflectors are pre-installed in 4' increments. When Grazing illumination is being used on a flat wall where no shadows are desired, Gammalux recommends a level 5 wall finish. The Grazing illumination optic will highlight all inconsistencies in the wall surface.

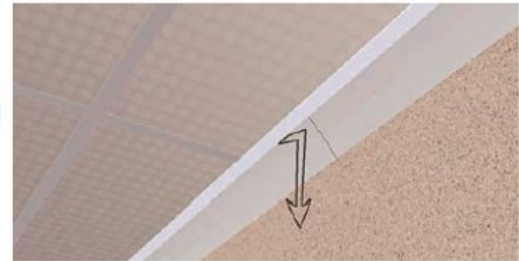

Gammalux Lighting Systems reserves the right to change the details of fixture design and construction at any time.

Run Length

Perimeter Series Mounting Styles

Mounting style from page 1: RECW/PR/GMR

Fixture is recessed above the ceiling line and against a side wall (**RECW**). The exposed portion of the side wall above the ceiling line should be finished to match the rest of the wall. The Plaster Rail (**PR**) is positioned with mud ribs facing down, allowing it to be 'mudded' into the face of the back wall. The fixture bottom features a mud flange (**GMR**), allowing it to be 'mudded' into the drywall or plaster ceiling. Exact field dimensions are required.

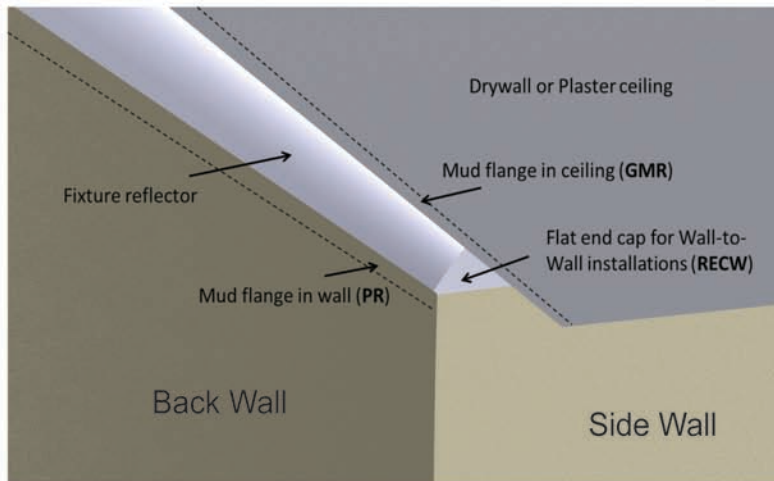

- PLASTER RAIL IS INSTALLED ONTO WALL BEFORE THE WALL IS FINISHED.
- PLASTER OR JOINT COMPOUND IS BLENDED DOWN THE WALL, EMBEDDING THE BOTTOM OF THE PLASTER RAIL INTO THE WALL.
- WALLS ARE FINISHED PER ARCHITECTURAL INSTRUCTIONS (SIDEWALL SHOULD BE FINISHED 4" ABOVE THE CEILING LINE AND 6" FROM THE BACK WALL).
- FIXTURE IS INSTALLED AND SUSPENDED FROM ABOVE.
- CEILING IS INSTALLED, FIXTURE BOTTOM FLANGE IS MUDDED OVER.
- FIXTURE IS MASKED AND CEILING IS FINISHED PER ARCHITECTURAL INSTRUCTIONS.

Perimeter Series Mounting Styles

Mounting style from page 1: RECW/PR/GFW

Fixture is recessed above the ceiling line and against a side wall (**RECW**). The exposed portion of the side wall above the ceiling line a telescoping end fixture may be required, resulting should be finished to match the rest of the wall. The Plaster Rail (**PR**) is positioned with mud ribs facing down, allowing it to be 'mudded' into the face of the back wall. The fixture bottom features a 1" flange (**GFW**), allowing it to rest under the ceiling material. Exact field dimensions are required.

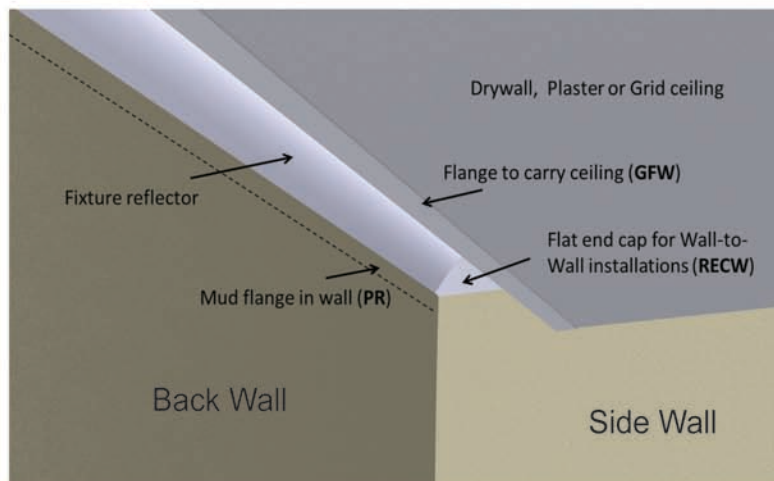

- PLASTER RAIL IS INSTALLED ONTO WALL BEFORE THE WALL IS FINISHED.
- PLASTER OR JOINT COMPOUND IS BLENDED DOWN THE WALL, EMBEDDING THE BOTTOM OF THE PLASTER RAIL INTO THE WALL.
- WALLS ARE FINISHED PER ARCHITECTURAL INSTRUCTIONS (SIDEWALL SHOULD BE FINISHED 4" ABOVE THE CEILING LINE AND 6" FROM THE BACK WALL).
- FIXTURE IS INSTALLED AND SUSPENDED FROM ABOVE.
- CEILING IS INSTALLED, FIXTURE BOTTOM FLANGE RESTS UNDER CEILING MATERIAL.
- FIXTURE IS MASKED AND CEILING IS FINISHED PER ARCHITECTURAL INSTRUCTIONS.

Mounting2_perimeter.jpg

Perimeter Series Mounting Styles

Mounting style from page 1: REC/WF/GMR

Fixture is recessed above the ceiling line and IS NOT touching a side wall (**REC**). The Wall Flange (**WF**) is positioned with mud ribs facing up and not used. The flange is visible on the back wall. The fixture's bottom trim and end caps feature a mud flange (**GMR**), allowing them to be 'mudded' into the drywall or plaster ceiling.

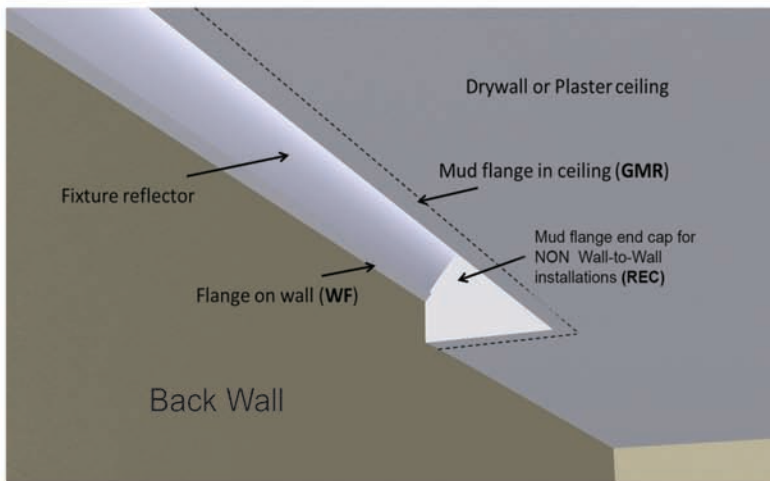

- WALLS ARE FINISHED PER ARCHITECTURAL INSTRUCTIONS.
- PLASTER RAIL IS INSTALLED ONTO WALL AFTER THE WALL IS FINISHED. MUD RIBS ARE FACING UP AND ARE NOT USED, PLASTER RAIL'S FLANGE IS VISIBLE ON THE BACK WALL.
- FIXTURE IS INSTALLED AND SUSPENDED FROM ABOVE.
- CEILING IS INSTALLED, FIXTURE'S BOTTOM FLANGE IS MUDDED OVER.
- FIXTURE IS MASKED AND CEILING IS FINISHED PER ARCHITECTURAL INSTRUCTIONS.

Perimeter Series Mounting Styles

Mounting style from page 1: REC/WF/GFW

Fixture is recessed above the ceiling line and IS NOT touching a side wall (**REC**). The Wall Flange (**WF**) is positioned with mud ribs facing up and not used. The plaster rail flange is visible on the back wall. The fixture's bottom trim and end caps feature a 1" flange (**GFW**), allowing them to rest under the ceiling material.

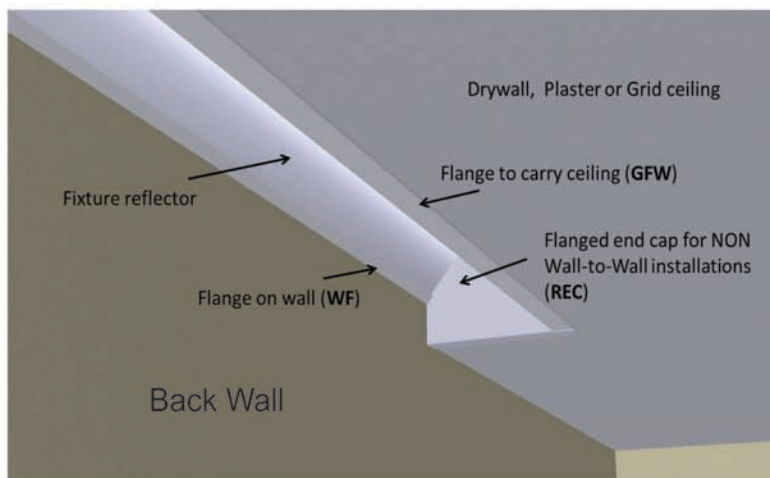

- WALLS ARE FINISHED PER ARCHITECTURAL INSTRUCTIONS. (SIDE WALL SHOULD BE FINISHED 4" ABOVE THE CEILING LINE AND 6" FROM THE BACK WALL).
- PLASTER RAIL IS INSTALLED ONTO WALL AFTER THE WALL IS FINISHED. MUD RIBS ARE FACING UP AND ARE NOT USED, PLASTER RAIL'S FLANGE IS VISIBLE ON THE BACK WALL.
- FIXTURE IS INSTALLED AND SUSPENDED FROM ABOVE.
- CEILING IS INSTALLED, FIXTURE'S BOTTOM FLANGE IS MUDDED OVER.
- FIXTURE IS MASKED AND CEILING IS FINISHED PER ARCHITECTURAL INSTRUCTIONS.

Perimeter Series Options

Perimeter Series Mounting Styles

Mounting style from page 1: REC/PR/GMR

Fixture is recessed above the ceiling line and IS NOT touching a side wall (**REC**). The Plaster Rail (**PR**) is positioned with mud ribs facing down, allowing it to be 'mudded' into the face of the back wall. The fixture bottom features a mud flange (**GMR**), allowing it to be 'mudded' into the drywall or plaster ceiling.

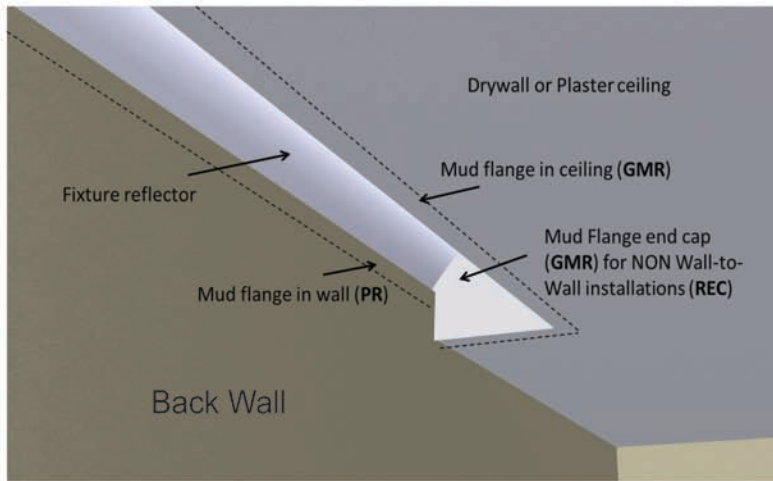

- PLASTER RAIL IS INSTALLED ONTO WALL BEFORE THE WALL IS FINISHED.
- FIXTURE IS ATTACHED TO PLASTER RAIL AND SUSPENDED FROM ABOVE.
- CEILING IS INSTALLED, FIXTURE IS MASKED.
- PLASTER OR JOINT COMPOUND IS BLENDED DOWN THE WALL, EMBEDDING THE BOTTOM OF THE PLASTER RAIL INTO THE WALL.
- CEILING MUD FLANGE IS COVERED BY PLASTER OR JOINT COMPOUND.
- WALLS AND CEILING ARE FINISHED PER ARCHITECTURAL INSTRUCTIONS

Perimeter Series Mounting Styles

Mounting style from page 1: REC/PR/GFW

Fixture is recessed above the ceiling line and IS NOT touching a side wall (**REC**). The Plaster Rail (**PR**) is positioned with mud ribs facing down, allowing it to be 'mudded' into the face of the back wall. The fixture bottom features a 1" flange (**GFW**), allowing it to rest under the ceiling material.

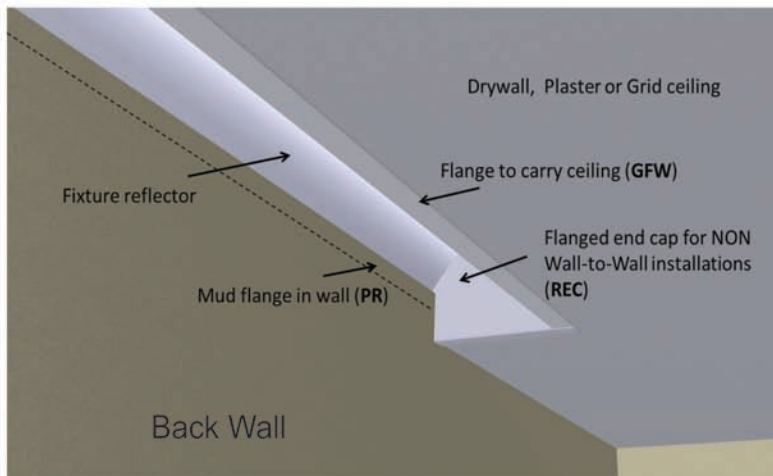

- PLASTER RAIL IS INSTALLED ONTO WALL BEFORE THE WALL IS FINISHED.
- FIXTURE IS ATTACHED TO PLASTER RAIL AND SUSPENDED FROM ABOVE.
- CEILING IS INSTALLED, FIXTURE IS MASKED.
- PLASTER OR JOINT COMPOUND IS BLENDED DOWN THE WALL, EMBEDDING THE BOTTOM OF THE PLASTER RAIL INTO THE WALL.
- WALLS AND CEILING ARE FINISHED PER ARCHITECTURAL INSTRUCTIONS.

Wall_interface1_perimeter.jpg

Wall Interface

WF The Wall Flange is made of the same material as the Plaster Rail. In applications where the flange is NOT to be mudded into the wall, the mud ribs should be facing up and not used.

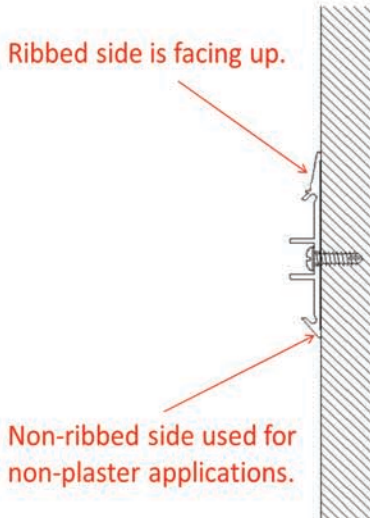

1) Wall Flange is installed with mud ribs facing up.

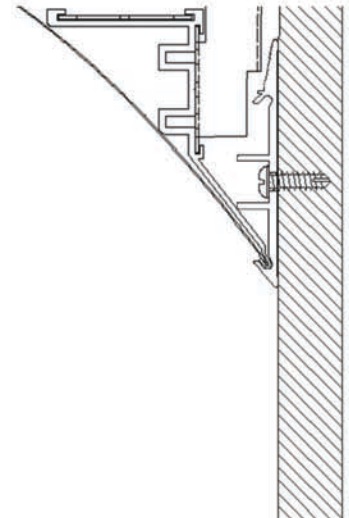

2) Fixture's reflector assembly is nested into groove in Wall Flange. Flange is visible on the wall.

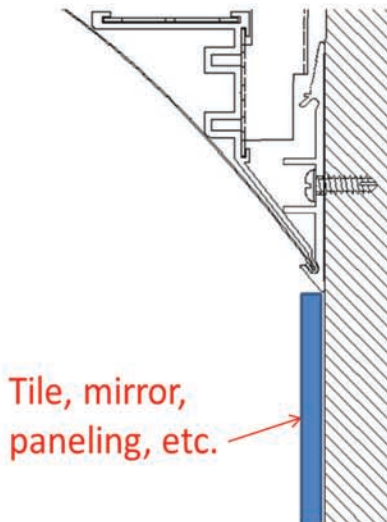

3) If required, materials can be added to wall and butted against the bottom of the Wall Flange. A bead of caulking or other filler material can be used to hide small gaps.

Custom Programmed Output

Custom Programmed Output can be specified to produce approximate Delivered Lumens per Foot, Percentage of High Output Value or Maximum Watts per Foot.

Delivered Lumens Per Foot

Gammalux deals only in delivered lumens per foot. When working to match or exceed a competitor product's Lumens Per Foot package, be sure you are looking at their Delivered (through the lens) lumens per foot, not their System (bare board) lumens per foot.

In the Gammalux item #, use **C** as the Output designator and add a fixture description stating the required Lumens Per Foot value (ie: if you need 600 lumens per foot delivered by the fixture, the line note would read "Program = 600 LPF").

Percentage of High Output Value

If the required delivered lumens per foot are not known, run lighting calculations using our High Output IES file and identify the percentage of increase or decrease required to produce the correct lighting in the space.

In the Gammalux item #, use **C** as the Output designator and add a fixture description stating the required percentage of decrease from our High Output value (ie: for 60% of our High Output value, the line note would read "Program = 60% of High Output").

Maximum Watts Per Foot

In the Gammalux item #, use **C** as the Output designator and add a fixture description stating the required Maximum Watts per Foot (ie: if you need the fixtures capped at a maximum of 7 watts per foot, the line note would read "Program = 7 WPF").

For all three methods, custom programming capability is currently 25-200% of our High Output value. For requirements outside of this range, consult factory.

Approved Cut Release option

If offered for Approved Cut Release in the Gammalux factory quote, the product in the accompanying purchase order is authorized by the GC to be released to production without the need for factory drawings for approval.

I confirm that:

- all ordering options are clearly noted (highlighted, boxed, written in, etc.) on page 1 of this fixture cut sheet
- quoted leadtime begins upon Gammalux's confirmation that the P.O. and marked cut sheet match their quote.
- the order will be released to production and a "record only" drawing will be provided prior to product shipment
- changes after Gammalux's release to production will result in a minimum 25% change fee which increases as production progresses.

General Contractor _____

GC's authorized Signature (or stamp below) _____

Signatory's printed name _____