

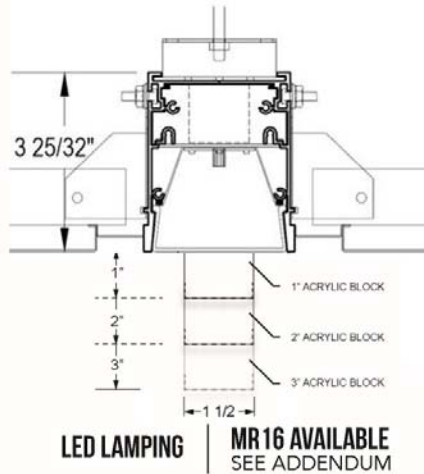

Click or scan QR code to view latest spec sheet



Revision Date: November 08, 2023
Gammalux Lighting Systems reserves the right to change details of fixture designs and construction at any time.



Click photo to view product page
Page 1: Overview & Nomenclature
Pages 2-3: Specifications
Pages 4-5: Photometric Info / Downloads
Page 6: Mounting Details
Pages 8-10: Images & Fascia Removal
Pages 11-13: Custom Programming

Product Overview (for complete specifications, see pages 2 & 3) *****NEW***** See last page for **APPROVED CUT RELEASE**.

Integration: GAMMALUX GX3D34RC2BX4 is approved for use in the following CertainTeed Architectural ceilings: Box 4, Deep Box 4, Multi-Box. GAMMALUX factory shop submittal drawings will be provided for each lighting fixture order. Fixture end cap includes field-removable flange for interface with cut panel in line with fixture.

Construction: I.C. rated. ARRA, RoHS, REACH and Prop 65 compliant. Runs can be built to field dims.

Illumination: Backlit acrylic block allows no visibility of LEDs, fasteners or fastener shadows. Approximate 2" separation of blocks in continuous runs. See installation images.

Electrical: LED components by major manufacturers, may be upgraded in the field to increase energy efficiency. Fixtures can be fitted with specialty LED and control components (consult factory). Standard Output, High Output and Custom Output options available.

Standard Nomenclature

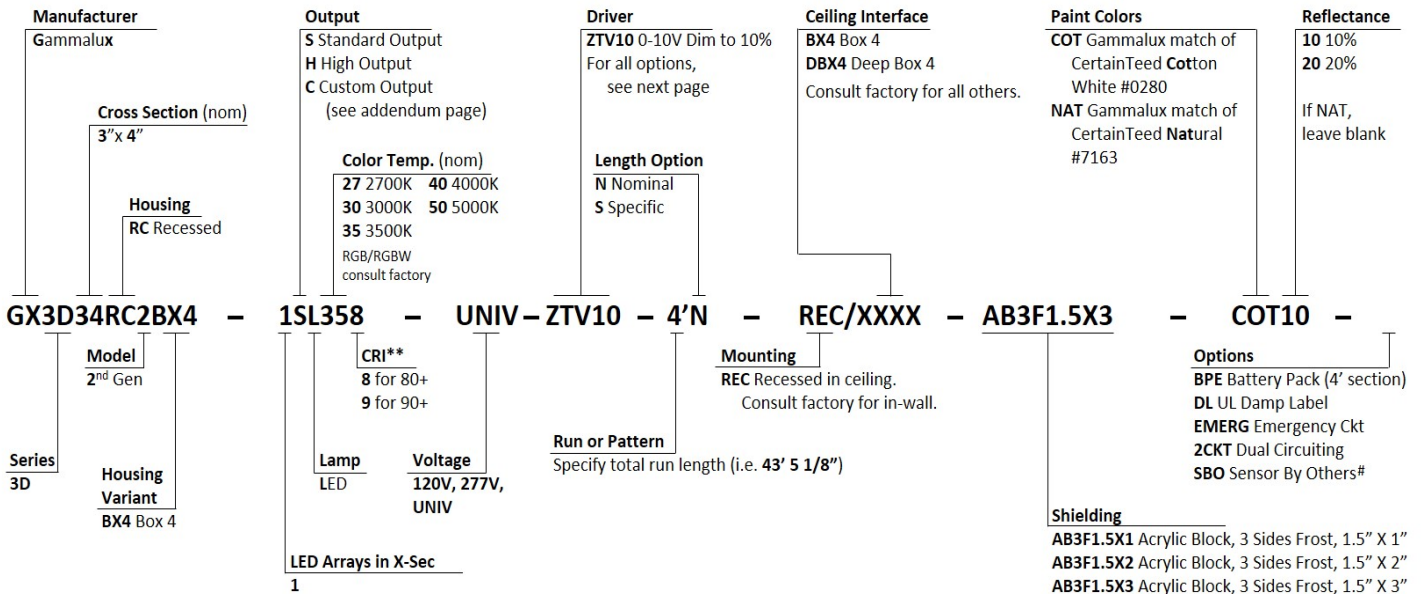

** 90+ CRI increases watts nom. 14.5%. # Sensor by Others (consult factory).

Specifications (continued on next page)

Electrical

Output: Standard (S) and high (H) options deliver a pre-set lumen package (see chart below). Custom-programmed output (C) is specified as LPF, WPF or % of High Output (see Custom Programmed Output page).

Static Driver: eldoLED [Optotronic](#)* programmable driver, wired for static operation (DVR).

0-10V Dimming: eldoLED [Optotronic](#)* programmable driver, wired for 0-10v control and dimming to 10% (ZTV10) or to 1% (ZTV1).

Step Dimming: Generic step dimming driver, two hot inputs for 100% and 50% output (SD2).

DALI Dimming: Generic DALI driver with two loose control wires exiting fixture at power feed location (DALI).

Lutron Dimming: [Hi-Lume](#) dim to 1% EcoSystem with Soft-On, Fade-to-Black (LDE1).

White Emitter: Nichia 757G emitters* binned within 3 MacAdam ellipses in Osram or Gammalux proprietary array. 90+ CRI option with extended lead time (CRI code 9) results in nominal 14.5% drop in efficacy; increase calculated watts 14.5%.

Battery Pack: Bodine [BSL10T3](#)* (BPE). 4W max input, 10W initial output, delivers min. 27% of High Output value per 4' length.

LED System: 70% lumen output (L70) at max 85 degrees C calculated at >60k hours. Fixtures are shipped with anti-static gloves to minimize the risk of damage to LEDs during installation. [5 year limited warranty](#).

Sensors: Sensors are as specified, confirmed by Gammalux prior to factory quote. Examples are Enlighted [Micro Sensor](#), Lutron [Athena Wireles Node](#), Lutron [Vive](#), Wattstopper [FS-205](#).

Upgrade Capability: LED assemblies can be replaced in the future with the latest factory-provided and fully warranted components. On-board sensors, control interface devices and alternate LED components may be specified (consult factory). Fixtures bear UL & cUL Dry Location label. Damp Location label available (DL).

*Subject to availability; may be substituted by Gammalux. Components and specifications may be changed without notice.

LUMENS AND WATTS BY OUTPUT OPTION AND LED COLOR @ 80+ CRI*											
STANDARD OUTPUT LED						HIGH OUTPUT LED					
AB3F1.5X1		DELIVERS: 509.7 LPF				AB3F1.5X1		DELIVERS: 679.6 LPF			
AB3F1.5X2		DELIVERS: 528.6 LPF				AB3F1.5X2		DELIVERS: 704.6 LPF			
AB3F1.5X3		DELIVERS: 520 LPF				AB3F1.5X3		DELIVERS: 693.4 LPF			
CCT	2700 K	3000 K	3500 K*	4000 K	5000 K	CCT	2700 K	3000 K	3500 K*	4000 K	5000 K
WATTS / FT.	6.3	5.9	5.8	5.7	5.4	WATTS / FT.	8.6	8.2	8	7.8	7.4
<small>*IES FILES WERE CREATED USING 3500K DIODES @80+ CRI. WATTAGE IS MULTIPLIED BY 1.08 FOR 2700K, 1.02 FOR 3000K, .98 FOR 4000K AND .93 FOR 5000K DIODES TO MAINTAIN THE SAME DELIVERED LUMENS THROUGHOUT ALL COLOR TEMPERATURES. FOR 90+ CRI, INCREASE WATTAGE BY 14.5%. SEE ADDENDUM FOR CUSTOM PROGRAMMING.</small>											

Construction

Housing: ARRA, RoHS, REACH and Prop 65 compliant. Extruded aluminum body 3.00" wide x 3.62" high, 6063T5, 0.070" min thickness. Individually mounted housing is 4' max. Fixtures are built per approved factory drawings and tested at the factory prior to shipping. Continuous runs and [patterns](#) are ordered, built and shipped with a single item #. Fixtures ordered as individuals are not designed to be joined together in the field.

Lamping: LED lamping fully illuminates acrylic blocks. Acrylic blocks are nominal 46" and separated approximately 2" in continuous runs. See installation images. Consult factory for custom length blocks and housings.

Mounting: Recessed into a Box 4 (REC/BX4) or Deep Box 4 (REC/DBX4) ceiling system by CertainTeed Architectural. Fixture end cap includes field-removable flange for interface with cut panel inline with fixture.

Specifications (continued)

Optical

Shielding: Acrylic block is frosted on ends and bottom, clear on sides. 1.5" wide x 1", 2" or 3" exposed height. No LEDs, fasteners or fastener shadows visible at any angle. Blocks are separated approximately 2" in continuous runs. See installation images.

Finish

Acid etched or clear anodized housing electrostatically sprayed with high solids aliphatic two component polyurethane high (**H**) or semi-gloss (**SG**) to an avg. thickness of 2 mils. Custom finish, consult factory. Wood Finishes, back page.



Packing and Shipping

Fixtures built for continuous rows and patterns are given a specific location identifier, clearly identified on factory layout drawings, the fixture's ID Label, protective wrapping and on each end of fixture carton. Shipping pallets are built with 2" clearance, extending beyond the length and width of cartons, providing shipping protection.

Approx. weight of 4' module is 46 lbs. including carton. Weight of pallet and supplemental packing materials not factored in.

Special Information

Due to the weight and standard joining methods of fixtures, housing length is 4' max.

For fascia plate removal, see supplemental information, page 8.

**Photometric Reports for
STANDARD OUTPUT FIXTURES**

FIXTURE USES 1" TALL ACRYLIC BLOCK (3 SIDES FROSTED) AND 3500K LEDS @ 80 CRI

IESNA: LM 79-2008
ISSUEDATE: 12/1/2016
TEST: 11534284.01 MOD TO SO
TESTLAB: UL Verification Services Inc.
MANUFAC: GAMMALUX LIGHTING SYSTEMS
LUMCAT: GB34RC2-1SOLED35-4'AB3F1.5X1-WS
LAMPS: WHITE LED ARRAY

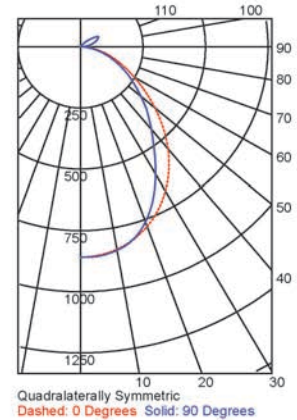
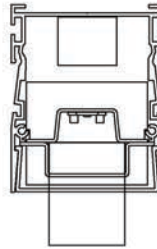

EFFICACY (Total): 80.9 LPW
DISTRIBUTION % UP: 6.4%
DISTRIBUTION % DOWN: 93.6%
CIE CLASSIFICATION: DIRECT

LUMINOUS OPENING: RECTANGULAR
Width: 0.13 (Feet)
Length: 3.83
Height: 0.08
INPUT WATTS: 25.2



FIXTURE USES 2" TALL ACRYLIC BLOCK (3 SIDES FROSTED) AND 3500K LEDS @ 80 CRI

IESNA: LM 79-2008
ISSUEDATE: 12/1/2016
TEST: 11534284.06 MOD TO SO
TESTLAB: UL Verification Services Inc.
MANUFAC: GAMMALUX LIGHTING SYSTEMS
LUMCAT: GB34RC2-1SOLED35-4'AB3F1.5X2-WS
LAMPS: WHITE LED ARRAY

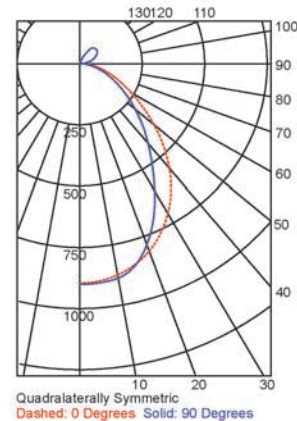
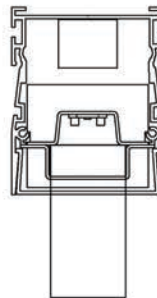

EFFICACY (Total): 83.9 LPW
DISTRIBUTION % UP: 10.7%
DISTRIBUTION % DOWN: 89.3%
CIE CLASSIFICATION: DIRECT

LUMINOUS OPENING: RECTANGULAR
Width: 0.13 (Feet)
Length: 3.83
Height: 0.08
INPUT WATTS: 25.2



FIXTURE USES 3" TALL ACRYLIC BLOCK (3 SIDES FROSTED) AND 3500K LEDS @ 80 CRI

IESNA: LM 79-2008
ISSUEDATE: 12/1/2016
TEST: 11534284.06 MOD TO SO
TESTLAB: UL Verification Services Inc.
MANUFAC: GAMMALUX LIGHTING SYSTEMS
LUMCAT: GB34RC2-1SOLED35-4'AB3F1.5X3-WS
LAMPS: WHITE LED ARRAY

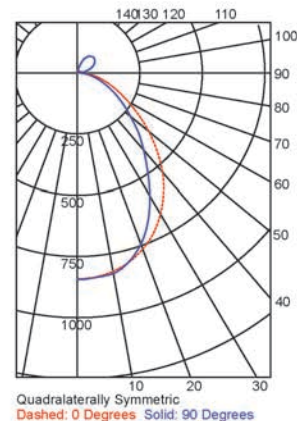
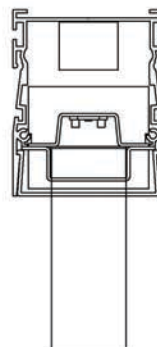

EFFICACY (Total): 82.5 LPW
DISTRIBUTION % UP: 12.9%
DISTRIBUTION % DOWN: 87.1%
CIE CLASSIFICATION: DIRECT

LUMINOUS OPENING: RECTANGULAR
Width: 0.13 (Feet)
Length: 3.83
Height: 0.25
INPUT WATTS: 25.2



**Photometric Reports for
HIGH OUTPUT FIXTURES**

FIXTURE USES 1" TALL ACRYLIC BLOCK (3 SIDES FROSTED) AND 3500K LEDS @ 80 CRI

IESNA: LM 79-2008
ISSUEDATE: 12/1/2016
TEST: 11534284.01
TESTLAB: UL Verification Services Inc.
MANUFAC: GAMMALUX LIGHTING SYSTEMS
LUMCAT: GB34RC2-1HOLED35-4*AB3F1.5X1-WS
LAMPS: WHITE LED ARRAY

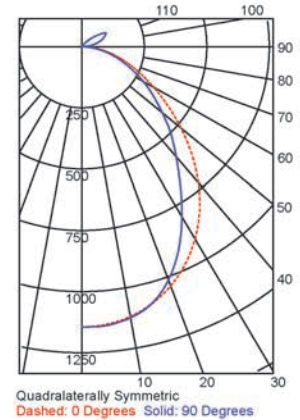
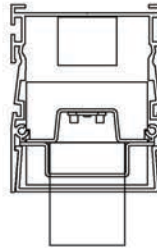

EFFICACY (Total): 76.8 LPW
DISTRIBUTION % UP: 6.4%
DISTRIBUTION % DOWN: 93.6%
CIE CLASSIFICATION: DIRECT

LUMINOUS OPENING: RECTANGULAR
Width: 0.13 (Feet)
Length: 3.83
Height: 0.08
INPUT WATTS: 35.4



FIXTURE USES 2" TALL ACRYLIC BLOCK (3 SIDES FROSTED) AND 3500K LEDS @ 80 CRI

IESNA: LM 79-2008
ISSUEDATE: 12/1/2016
TEST: 11534284.06
TESTLAB: UL Verification Services Inc.
MANUFAC: GAMMALUX LIGHTING SYSTEMS
LUMCAT: GB34RC2-1HOLED35-4*AB3F1.5X2-WS
LAMPS: WHITE LED ARRAY

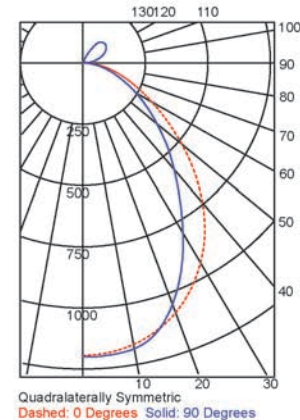
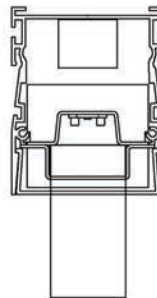

EFFICACY (Total): 79.2 LPW
DISTRIBUTION % UP: 10.7%
DISTRIBUTION % DOWN: 89.3%
CIE CLASSIFICATION: DIRECT

LUMINOUS OPENING: RECTANGULAR
Width: 0.13 (Feet)
Length: 3.83
Height: 0.08
INPUT WATTS: 35.6



FIXTURE USES 3" TALL ACRYLIC BLOCK (3 SIDES FROSTED) AND 3500K LEDS @ 80 CRI

IESNA: LM 79-2008
ISSUEDATE: 12/1/2016
TEST: 11534284.06
TESTLAB: UL Verification Services Inc.
MANUFAC: GAMMALUX LIGHTING SYSTEMS
LUMCAT: GB34RC2-1HOLED35-4*AB3F1.5X3-WS
LAMPS: WHITE LED ARRAY

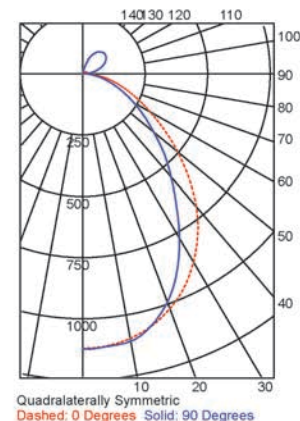
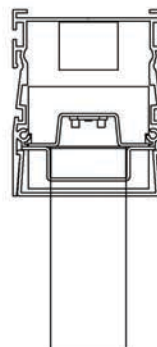

EFFICACY (Total): 78.1 LPW
DISTRIBUTION % UP: 12.9%
DISTRIBUTION % DOWN: 87.1%
CIE CLASSIFICATION: DIRECT

LUMINOUS OPENING: RECTANGULAR
Width: 0.13 (Feet)
Length: 3.83
Height: 0.25
INPUT WATTS: 35.5



Mounting Details

Factory Drawings: Fully dimensioned factory drawings will be provided upon receipt of purchase order.

Box 4 Ceiling:

Specify **BX4** code in catalog #

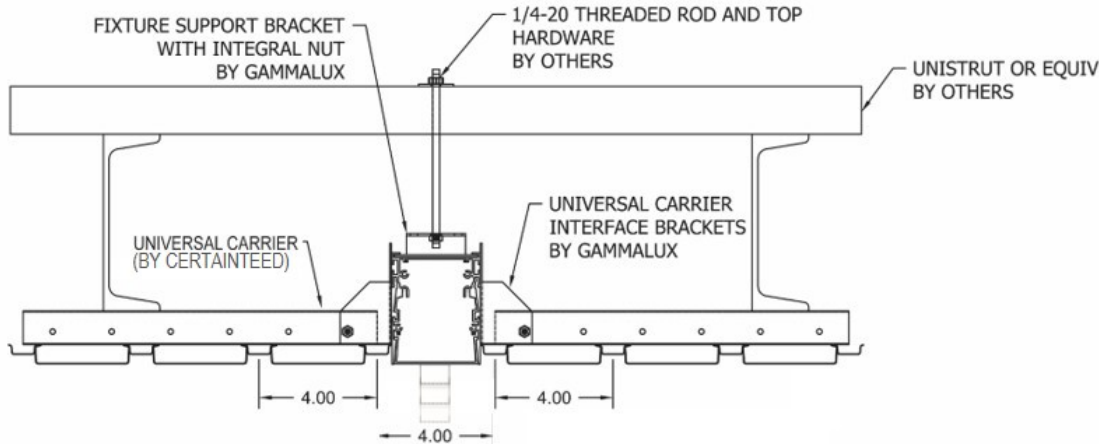

Deep Box 4 Ceiling:

Specify **DBX4** code in catalog #

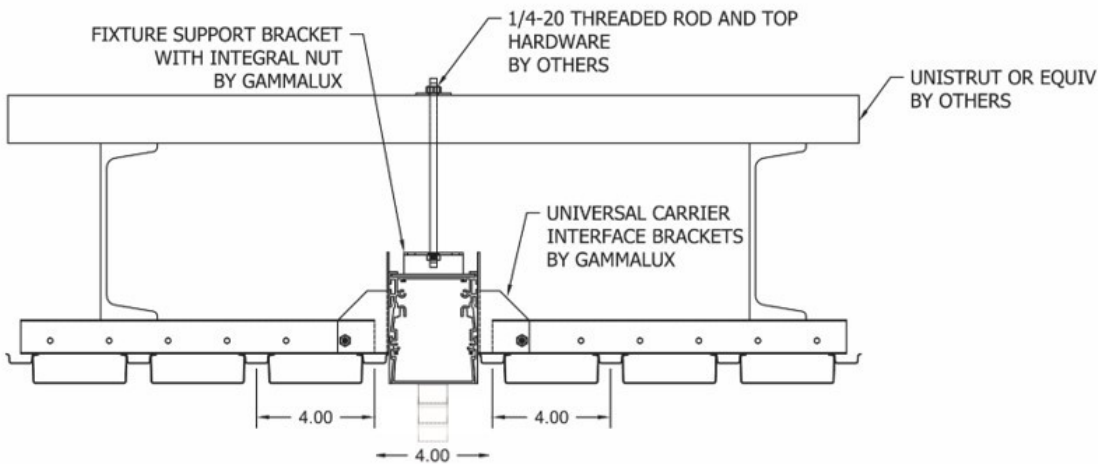

Mounting bracket is field adjustable to accommodate Box 4 or Deep 4

Gammalux Lighting Systems reserves the right to change the details of fixture design and construction at any time.

Product Images



SIDE VIEW



BOTTOM VIEW

1" ACRYLIC BLOCK



SIDE VIEW



BOTTOM VIEW

2" ACRYLIC BLOCK



SIDE VIEW



BOTTOM VIEW

3" ACRYLIC BLOCK

Sample Installations

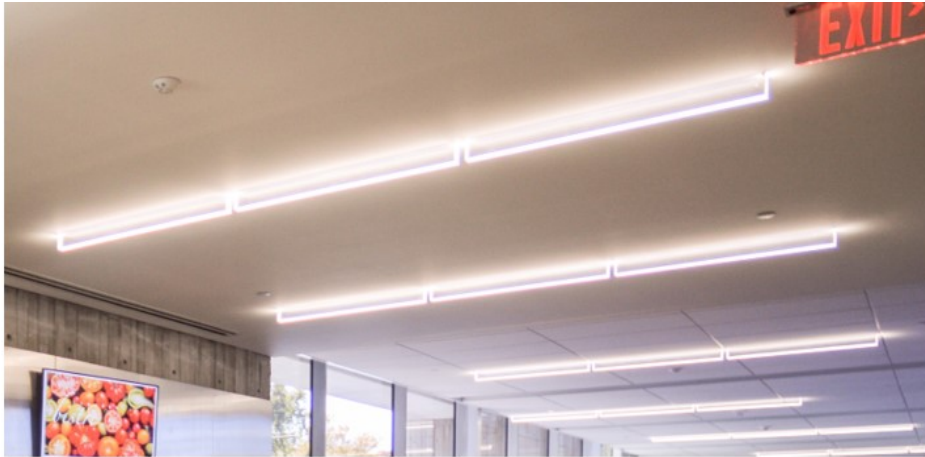

Continuous run of 3-sides frosted



Individual 3-sides frosted

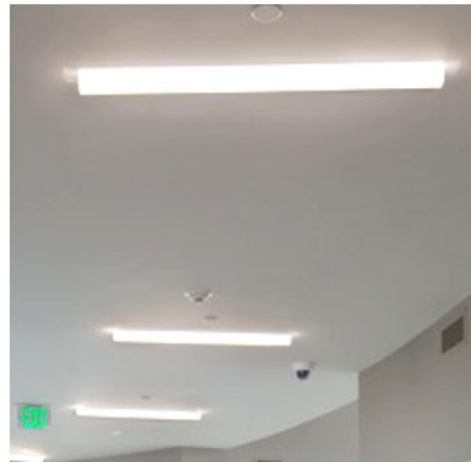

Individual 5-sides frosted

Fascia Plate Removal

Fascia Plate Removal

Step 1

Insert thin metal between fascia plate and housing side. Wrap metal in tape to avoid damaging the housing finish.



Step 2

Pry fascia plate out of housing.



Step 1

Lift fascia plate as evenly as possible.
Repeat at other end.



Custom Programmed Output

Custom Programmed Output can be specified to produce approximate Delivered Lumens per Foot, Percentage of High Output Value or Maximum Watts per Foot.

Delivered Lumens Per Foot

Gammalux deals only in delivered lumens per foot. When working to match or exceed a competitor product's Lumens Per Foot package, be sure you are looking at their Delivered (through the lens) lumens per foot, not their System (bare board) lumens per foot.

In the Gammalux item #, use **C** as the Output designator and add a fixture description stating the required Lumens Per Foot value (ie: if you need 600 lumens per foot delivered by the fixture, the line note would read "Program = 600 LPF").

Percentage of High Output Value

If the required delivered lumens per foot are not known, run lighting calculations using our High Output IES file and identify the percentage of increase or decrease required to produce the correct lighting in the space.

In the Gammalux item #, use **C** as the Output designator and add a fixture description stating the required percentage of decrease from our High Output value (ie: for 60% of our High Output value, the line note would read "Program = 60% of High Output").

Maximum Watts Per Foot

In the Gammalux item #, use **C** as the Output designator and add a fixture description stating the required Maximum Watts per Foot (ie: if you need the fixtures capped at a maximum of 7 watts per foot, the line note would read "Program = 7 WPF").

For all three methods, custom programming capability is currently 25-200% of our High Output value. For requirements outside of this range, consult factory.

Wood Finishes

Fixture housings are powder coated with a base finish, baked, then wrapped in a film with the decorative grain pattern. Baking the housing again allows the grain to become embedded into the powder coated finish. This is not a decal or veneer. Additional lead time and cost increases apply. Consult factory for pricing. Swatches are 3" x 4".



FINISH CODE: KPI



FINISH CODE: MED



FINISH CODE: HCH

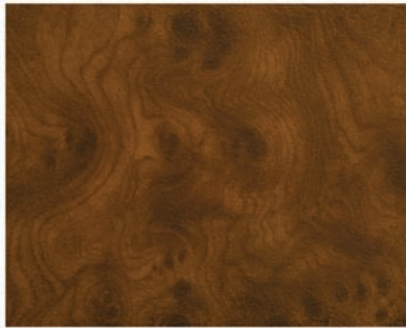

FINISH CODE: WAL



FINISH CODE: AOK



FINISH CODE: FWG

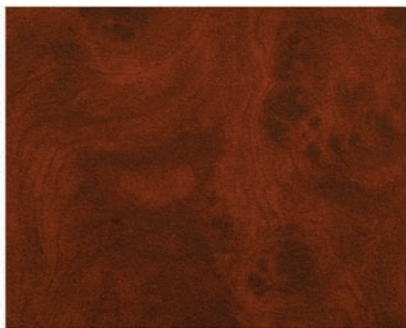

FINISH CODE: MH1

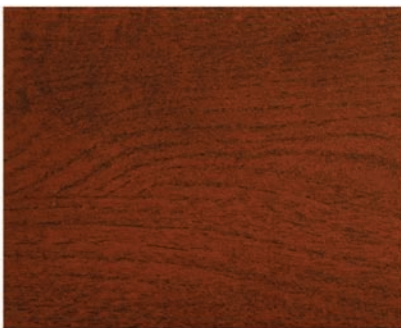

FINISH CODE: MH2

DUE TO VARIANCES IN MONITORS AND PRINTERS, ACTUAL FINISHES MAY APPEAR DIFFERENT FROM SWATCHES.

Approved Cut Release option

If offered for Approved Cut Release in the Gammalux factory quote, the product in the accompanying purchase order is authorized by the GC to be released to production without the need for factory drawings for approval.

I confirm that:

- all ordering options are clearly noted (highlighted, boxed, written in, etc.) on page 1 of this fixture cut sheet
- quoted leadtime begins upon Gammalux's confirmation that the P.O. and marked cut sheet match their quote.
- the order will be released to production and a "record only" drawing will be provided prior to product shipment
- changes after Gammalux's release to production will result in a minimum 25% change fee which increases as production progresses.

General Contractor _____

GC's authorized Signature (or stamp below) _____

Signatory's printed name _____