

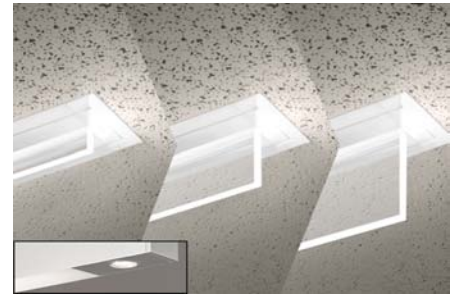

Click or scan QR code to view latest spec sheet

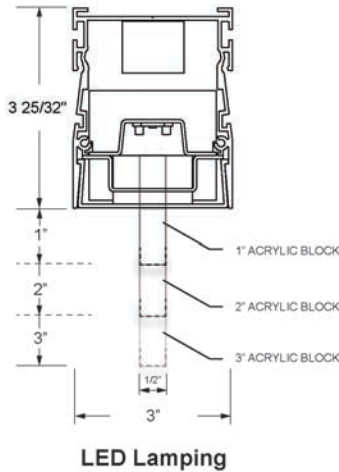

Click photo to view product page  
Page 1: Overview & Nomenclature  
Pages 2-3: Specifications  
Pages 4-5: Photometric Info / Downloads  
Page 6: Mounting Details  
Pages 8-10: Images & Fascia Removal  
Pages 11-13: Custom Programming

Revision Date: November 08, 2023  
Gammalux Lighting Systems reserves the right to change details of fixture designs and construction at any time.

**Product Overview** (for complete specifications, see pages 2 & 3) \*\*\*\*\*NEW\*\*\*\*\* See last page for **APPROVED CUT RELEASE**.  
**Construction:** ARRA, RoHS, REACH and Prop 65 compliant. Extruded aluminum housing is 4' max length and individual mount only. No exposed fasteners.

**Illumination:** Primarily direct illumination. Acrylic blocks fully illuminated, no LEDs visible at any angle.

**Electrical:** LED components by major manufacturers, may be upgraded in the field to increase energy efficiency. Fixtures can be fitted with specialty LED and control components (consult factory). Standard Output, High Output and Custom Output options available.

**Optical:** .5" wide by 1", 2" or 3" exposed acrylic block with no LED images and no fastener shadows. Approximate 2" separation of blocks in continuous runs. See installation images.

## Standard Nomenclature

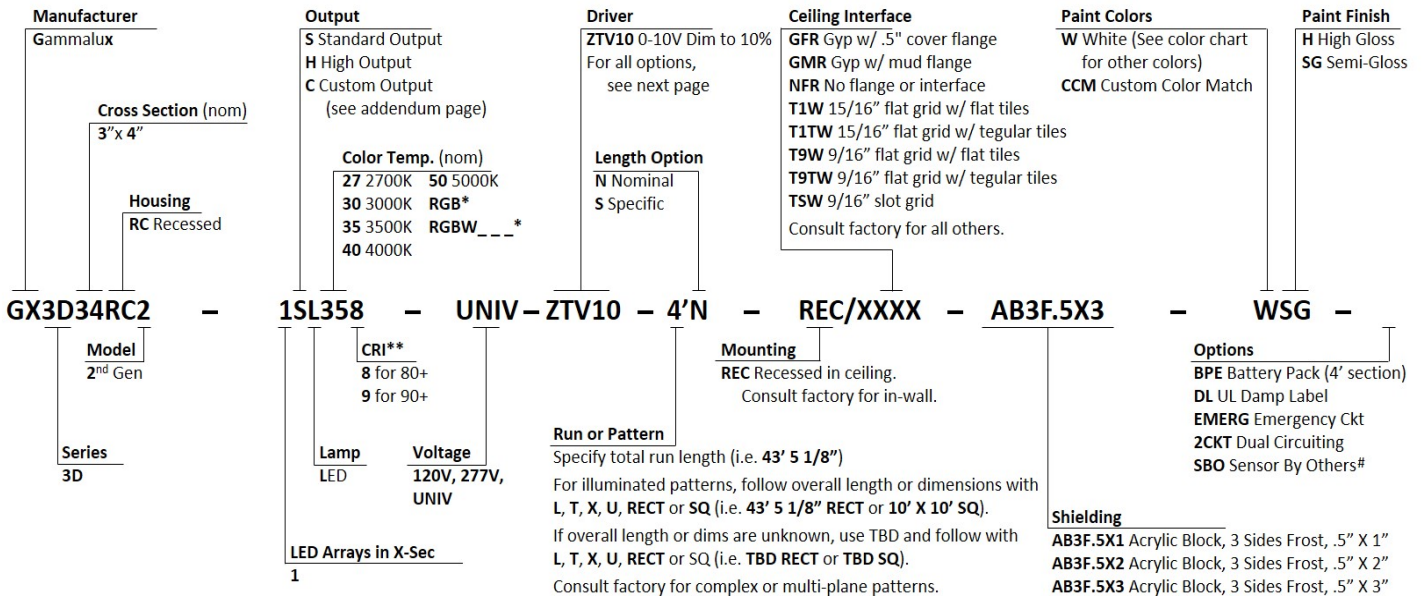

\*\* 90+ CRI increases watts nom. 14.5%. # Sensor by Others (consult factory).

## Specifications (continued on next page)

### Electrical

**Output:** Standard (S) and high (H) options deliver a pre-set lumen package (see chart below). Custom-programmed output (C) is specified as LPF, WPF or % of High Output (see Custom Programmed Output page).

**Static Driver:** eldoLED [Optotronic\\*](#) programmable driver, wired for static operation (DVR).

**0-10V Dimming:** eldoLED [Optotronic\\*](#) programmable driver, wired for 0-10v control and dimming to 10% (ZTV10) or to 1% (ZTV1).

**Step Dimming:** Generic step dimming driver, two hot inputs for 100% and 50% output (SD2).

**DALI Dimming:** Generic DALI driver with two loose control wires exiting fixture at power feed location (DALI).

**Lutron Dimming:** [Hi-Lume](#) dim to 1% EcoSystem with Soft-On, Fade-to-Black (LDE1).

**White Emitter:** Nichia 757G emitters\* binned within 3 MacAdam ellipses in Osram or Gammalux proprietary array. 90+ CRI option with extended lead time (CRI code 9) results in nominal 14.5% drop in efficacy; increase calculated watts 14.5%.

**Battery Pack:** Bodine [BSL10T3\\*](#) (BPE). 4W max input, 10W initial output, delivers min. 27% of High Output value per 4' length.

**LED System:** 70% lumen output (L70) at max 85 degrees C calculated at >60k hours. Fixtures are shipped with anti-static gloves to minimize the risk of damage to LEDs during installation. [5 year limited warranty](#).

**Sensors:** Sensors are as specified, confirmed by Gammalux prior to factory quote. Examples are Enlighted [Micro Sensor](#), Lutron [Athena Wireles Node](#), Lutron [Vive](#), Wattstopper [FS-205](#).

**Upgrade Capability:** LED assemblies can be replaced in the future with the latest factory-provided and fully warranted components. On-board sensors, control interface devices and alternate LED components may be specified (consult factory). Fixtures bear UL & cUL Dry Location label. Damp Location label available (DL).

\*Subject to availability; may be substituted by Gammalux. Components and specifications may be changed without notice.

LUMENS AND WATTS BY OUTPUT OPTION AND LED COLOR @ 80+ CRI*											
STANDARD OUTPUT LED						HIGH OUTPUT LED					
AB3F.5X1		DELIVERS: <b>472.6 LPF</b>				AB3F.5X1		DELIVERS: <b>543.7 LPF</b>			
AB3F.5X2		DELIVERS: <b>422.8 LPF</b>				AB3F.5X2		DELIVERS: <b>563.8 LPF</b>			
AB3F.5X3		DELIVERS: <b>416 LPF</b>				AB3F.5X3		DELIVERS: <b>554.6 LPF</b>			
CCT	2700 K	3000 K	3500 K*	4000 K	5000 K	CCT	2700 K	3000 K	3500 K*	4000 K	5000 K
WATTS / FT.	6.3	5.9	5.8	5.7	5.4	WATTS / FT.	8.6	8.2	8	7.8	7.4
<small>*IES FILES WERE CREATED USING 3500K DIODES @80+ CRI. WATTAGE IS MULTIPLIED BY 1.08 FOR 2700K, 1.02 FOR 3000K, .98 FOR 4000K AND .93 FOR 5000K DIODES TO MAINTAIN THE SAME DELIVERED LUMENS THROUGHOUT ALL COLOR TEMPERATURES. FOR 90+ CRI, INCREASE WATTAGE BY 14.5%. SEE ADDENDUM FOR CUSTOM PROGRAMMING.</small>											

### Construction

**Housing:** ARRA, RoHS, REACH and Prop 65 compliant. Extruded aluminum body 3.00" wide x 3.62" high, 6063T5, 0.070" min thickness. Individually mounted housing is 4' max. Fixtures are built per approved factory drawings and tested at the factory prior to shipping. Continuous runs and [patterns](#) are ordered, built and shipped with a single item #. Fixtures ordered as individuals are not designed to be joined together in the field.

**Lamping:** LED lamping fully illuminates acrylic blocks. Acrylic blocks are nominal 46" and separated approximately 2" in continuous runs. See installation images. Consult factory for custom length blocks and housings.

**Mounting:** Recessed into a ceiling system (REC). Fixtures surrounded by grid should be ordered in Nominal length (Length Option N) and can be installed from below. Consult factory for in-wall installation. Mud flange (GMR) includes integral expansion gap to allow for heat expansion with no pressure on surrounding plaster. GMR FIXTURE MUST BE INSTALLED PRIOR TO GYP.

## Specifications (continued)

### Optical

**Shielding:** Acrylic block is frosted on ends and bottom, clear on sides. .5" wide x 1", 2" or 3" exposed height. No LEDs, fasteners or fastener shadows visible at any angle. Blocks are separated approximately 2" in continuous runs. See installation images.

### Finish

Acid etched or clear anodized housing electrostatically sprayed with high solids aliphatic two component polyurethane high (**H**) or semi-gloss (**SG**) to an avg. thickness of 2 mils. Custom finish, consult factory. Wood Finishes, back page.



### Packing and Shipping

Fixtures built for continuous rows and patterns are given a specific location identifier, clearly identified on factory layout drawings, the fixture's ID Label, protective wrapping and on each end of fixture carton. Shipping pallets are built with 2" clearance, extending beyond the length and width of cartons, providing shipping protection.

Approx. weight of 4' module is 46 lbs. including carton. Weight of pallet and supplemental packing materials not factored in.

### Special Information

Due to the weight and standard joining methods of fixtures, housing length is 4' max.

For fascia plate removal, see supplemental information, page 8.

**Photometric Reports for  
STANDARD OUTPUT FIXTURES**

**FIXTURE USES 1" TALL ACRYLIC BLOCK (3 SIDES FROSTED) AND 3500K LEDS @ 80 CRI**

IESNA: LM 79-2008  
ISSUEDATE: 12/1/2016  
TEST: 11534284.01 MOD TO SO  
TESTLAB: UL Verification Services Inc.  
MANUFAC: GAMMALUX LIGHTING SYSTEMS  
LUMCAT: GB34RC2-1SOLED35-4'AB3F.5X1-WSG  
LAMPS: WHITE LED ARRAY

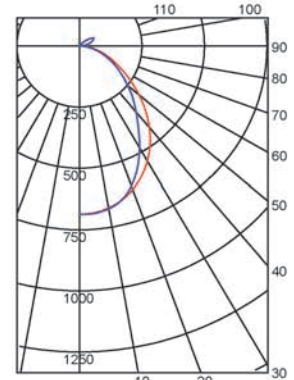
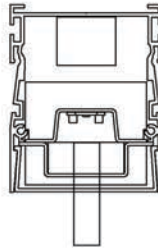

EFFICACY (Total): 64.7 LPW  
DISTRIBUTION % UP: 6.4%  
DISTRIBUTION % DOWN: 93.6%  
CIE CLASSIFICATION: DIRECT

LUMINOUS OPENING: RECTANGULAR  
Width: 0.13 (Feet)  
Length: 3.83  
Height: 0.08  
INPUT WATTS: 25.2



Quadrilaterally Symmetric  
Dashed: 0 Degrees Solid: 90 Degrees

**FIXTURE USES 2" TALL ACRYLIC BLOCK (3 SIDES FROSTED) AND 3500K LEDS @ 80 CRI**

IESNA: LM 79-2008  
ISSUEDATE: 12/1/2016  
TEST: 11534284.06 MOD TO SO  
TESTLAB: UL Verification Services Inc.  
MANUFAC: GAMMALUX LIGHTING SYSTEMS  
LUMCAT: GB34RC2-1SOLED35-4'AB3F.5X2-WSG  
LAMPS: WHITE LED ARRAY

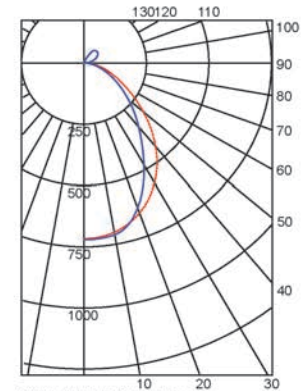
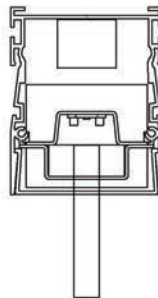

EFFICACY (Total): 67.1 LPW  
DISTRIBUTION % UP: 10.7%  
DISTRIBUTION % DOWN: 89.3%  
CIE CLASSIFICATION: DIRECT

LUMINOUS OPENING: RECTANGULAR  
Width: 0.13 (Feet)  
Length: 3.83  
Height: 0.08  
INPUT WATTS: 25.2



Quadrilaterally Symmetric  
Dashed: 0 Degrees Solid: 90 Degrees

**FIXTURE USES 3" TALL ACRYLIC BLOCK (3 SIDES FROSTED) AND 3500K LEDS @ 80 CRI**

IESNA: LM 79-2008  
ISSUEDATE: 12/1/2016  
TEST: 11534284.06 MOD TO SO  
TESTLAB: UL Verification Services Inc.  
MANUFAC: GAMMALUX LIGHTING SYSTEMS  
LUMCAT: GB34RC2-1SOLED35-4'AB3F.5X3-WSG  
LAMPS: WHITE LED ARRAY

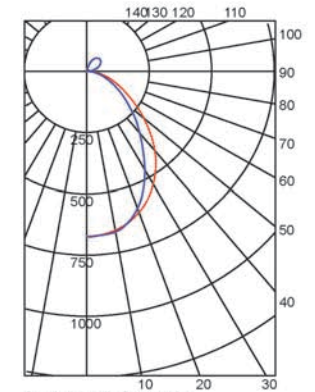
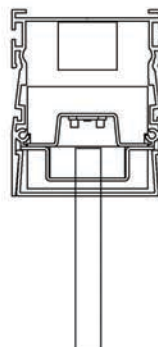

EFFICACY (Total): 66.0 LPW  
DISTRIBUTION % UP: 12.9%  
DISTRIBUTION % DOWN: 87.1%  
CIE CLASSIFICATION: DIRECT

LUMINOUS OPENING: RECTANGULAR  
Width: 0.13 (Feet)  
Length: 3.83  
Height: 0.25  
INPUT WATTS: 25.2



Quadrilaterally Symmetric  
Dashed: 0 Degrees Solid: 90 Degrees

**Photometric Reports for  
HIGH OUTPUT FIXTURES**

**FIXTURE USES 1" TALL ACRYLIC BLOCK (3 SIDES FROSTED) AND 3500K LEDS @ 80 CRI**

IESNA: LM 79-2008  
ISSUEDATE: 12/1/2016  
TEST: 11534284.01  
TESTLAB: UL Verification Services Inc.  
MANUFAC: GAMMALUX LIGHTING SYSTEMS  
LUMCAT: GB34RC2-1HOLED35-4'AB3F.5X1-WSG  
LAMPS: WHITE LED ARRAY

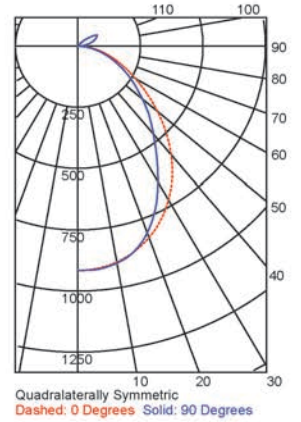
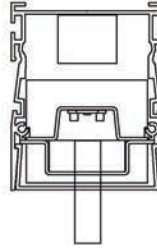

EFFICACY (Total): 61.4 LPW  
DISTRIBUTION % UP: 6.4%  
DISTRIBUTION % DOWN: 93.6%  
CIE CLASSIFICATION: DIRECT

LUMINOUS OPENING: RECTANGULAR  
Width: 0.13 (Feet)  
Length: 3.83  
Height: 0.08  
INPUT WATTS: 35.4



**FIXTURE USES 2" TALL ACRYLIC BLOCK (3 SIDES FROSTED) AND 3500K LEDS @ 80 CRI**

IESNA: LM 79-2008  
ISSUEDATE: 12/1/2016  
TEST: 11534284.06  
TESTLAB: UL Verification Services Inc.  
MANUFAC: GAMMALUX LIGHTING SYSTEMS  
LUMCAT: GB3RC2-1HOLED35-4'AB3F.5X2-WSG  
LAMPS: WHITE LED ARRAY

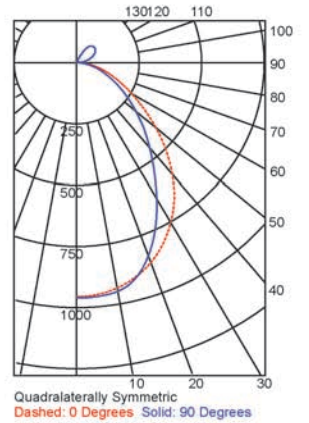
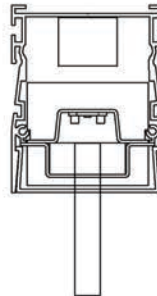

EFFICACY (Total): 63.3 LPW  
DISTRIBUTION % UP: 10.7%  
DISTRIBUTION % DOWN: 89.3%  
CIE CLASSIFICATION: DIRECT

LUMINOUS OPENING: RECTANGULAR  
Width: 0.13 (Feet)  
Length: 3.83  
Height: 0.08  
INPUT WATTS: 35.6



**FIXTURE USES 3" TALL ACRYLIC BLOCK (3 SIDES FROSTED) AND 3500K LEDS @ 80 CRI**

IESNA: LM 79-2008  
ISSUEDATE: 12/1/2016  
TEST: 11534284.06  
TESTLAB: UL Verification Services Inc.  
MANUFAC: GAMMALUX LIGHTING SYSTEMS  
LUMCAT: GB34RC2-1HOLED35-4'AB3F1.5X3-WSC  
LAMPS: WHITE LED ARRAY

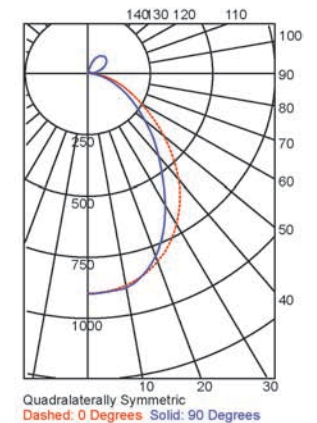
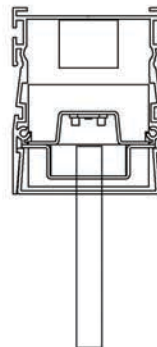

EFFICACY (Total): 62.5 LPW  
DISTRIBUTION % UP: 12.9%  
DISTRIBUTION % DOWN: 87.1%  
CIE CLASSIFICATION: DIRECT

LUMINOUS OPENING: RECTANGULAR  
Width: 0.13 (Feet)  
Length: 3.83  
Height: 0.25  
INPUT WATTS: 35.5



## Mounting Details

**Factory Drawings:** Fully dimensioned factory drawings will be provided upon receipt of purchase order.

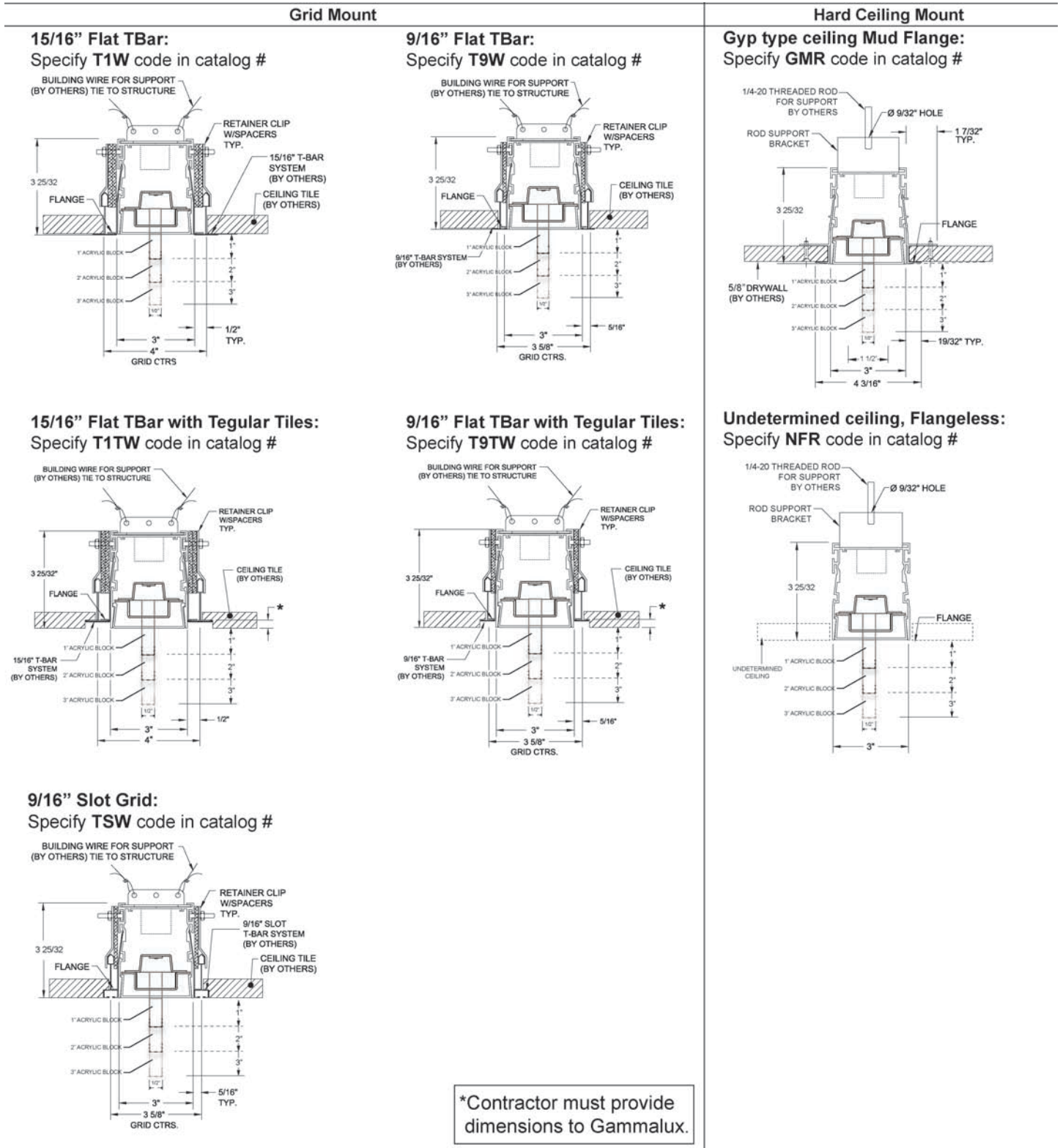

Gammalux Lighting Systems reserves the right to change the details of fixture design and construction at any time.

**Product Images**



SIDE VIEW



BOTTOM VIEW

**1" ACRYLIC BLOCK**



SIDE VIEW



BOTTOM VIEW

**2" ACRYLIC BLOCK**



SIDE VIEW



BOTTOM VIEW

**3" ACRYLIC BLOCK**

## Sample Installations



Continuous run of 3-sides frosted



Individual 3-sides frosted

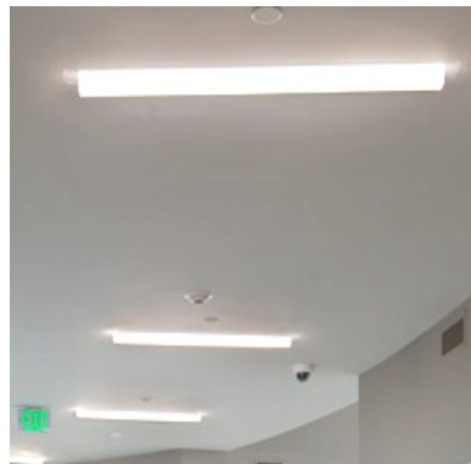

Individual 5-sides frosted



## Fascia Plate Removal

### Fascia Plate Removal

#### Step 1

Insert thin metal between fascia plate and housing side. Wrap metal in tape to avoid damaging the housing finish.



#### Step 2

Pry fascia plate out of housing.



#### Step 1

Lift fascia plate as evenly as possible.  
Repeat at other end.



---

## Custom Programmed Output

---

**Custom Programmed Output** can be specified to produce approximate Delivered Lumens per Foot, Percentage of High Output Value or Maximum Watts per Foot.

### Delivered Lumens Per Foot

Gammalux deals only in delivered lumens per foot. When working to match or exceed a competitor product's Lumens Per Foot package, be sure you are looking at their Delivered (through the lens) lumens per foot, not their System (bare board) lumens per foot.

In the Gammalux item #, use **C** as the Output designator and add a fixture description stating the required Lumens Per Foot value (ie: if you need 600 lumens per foot delivered by the fixture, the line note would read "Program = 600 LPF").

### Percentage of High Output Value

If the required delivered lumens per foot are not known, run lighting calculations using our High Output IES file and identify the percentage of increase or decrease required to produce the correct lighting in the space.

In the Gammalux item #, use **C** as the Output designator and add a fixture description stating the required percentage of decrease from our High Output value (ie: for 60% of our High Output value, the line note would read "Program = 60% of High Output").

### Maximum Watts Per Foot

In the Gammalux item #, use **C** as the Output designator and add a fixture description stating the required Maximum Watts per Foot (ie: if you need the fixtures capped at a maximum of 7 watts per foot, the line note would read "Program = 7 WPF").

For all three methods, custom programming capability is currently 25-200% of our High Output value. For requirements outside of this range, consult factory.

## Wood Finishes

Fixture housings are powder coated with a base finish, baked, then wrapped in a film with the decorative grain pattern. Baking the housing again allows the grain to become embedded into the powder coated finish. This is not a decal or veneer. Additional lead time and cost increases apply. Consult factory for pricing. Swatches are 3" x 4".



FINISH CODE: KPI



FINISH CODE: MED



FINISH CODE: HCH

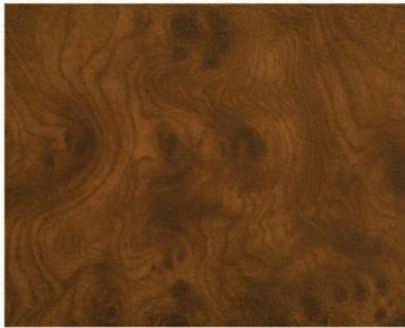

FINISH CODE: WAL



FINISH CODE: AOK



FINISH CODE: FWG

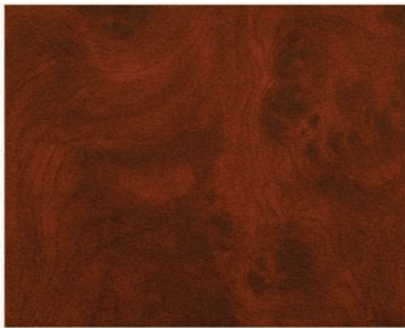

FINISH CODE: MH1



FINISH CODE: MH2

**DUE TO VARIANCES IN MONITORS AND PRINTERS, ACTUAL FINISHES MAY APPEAR DIFFERENT FROM SWATCHES.**

---

### Approved Cut Release option

---

If offered for Approved Cut Release in the Gammalux factory quote, the product in the accompanying purchase order is authorized by the GC to be released to production without the need for factory drawings for approval.

I confirm that:

- all ordering options are clearly noted (highlighted, boxed, written in, etc.) on page 1 of this fixture cut sheet
- quoted leadtime begins upon Gammalux's confirmation that the P.O. and marked cut sheet match their quote.
- the order will be released to production and a "record only" drawing will be provided prior to product shipment
- changes after Gammalux's release to production will result in a minimum 25% change fee which increases as production progresses.

General Contractor \_\_\_\_\_

GC's authorized Signature (or stamp below) \_\_\_\_\_

Signatory's printed name \_\_\_\_\_