

LED WATTAGE CHART

	16L	32L	48L	64L
700 milliamps	36w (4385-4720 Lumens)	71w (8770-9439 Lumens)	104w (13154-14159 Lumens)	136w (17539-18897 Lumens)
1050 milliamps	56w (6022-6482 Lumens)	106w (11797-12698 Lumens)	156w (17360-18686 Lumens)	205w (22627-24355 Lumens)

Form

- Elegant Rectilinear Extruded Aluminum Housing
- Corrosion Resistant Stainless Steel External Hardware
- Sleek, Low Profile Housing
- Spec Grade Performance
- Engineered For Optimum Thermal Management
- Anchor Base Plate For Easy Installation
- 8 Architectural Finishes Standard, RAL Colors Available

Function

- Micro Optics IES Distributions T2, T3, T4, T5
- 0-10V Dimming Drivers THD @ Max Load < 15%
- Power factor @ Max Load < 0.95
- 2700K, 3000K, 3500K, 4000K, Or 5000K
- 16L to 48L LED Configuration
- 36-205 Watts (Single Head Wattage)
- CRI 70, 80, or 90
- Extruded Aluminum Heat Sink
- 5 Mils Powder Coat
- Aluminum Pole .250 Wall

Reliability

- Silicone Micro Optics
- 5 Year Standard Warranty
- IP67 Optics
- Reduces Energy Consumption And Costs Up To 65%
- Dark Sky Approved







Project Name:

Type:

TRC-5 ORDERING GUIDE

*Ordering information for Pole & Fixture

Cat#	Light Dist.	No. of LEDs	Milliamps	Kelvin Temp	Volts
Trac 5 (TRC-5)	Type 2 (T2)	16 (16L)	700 (7)	2700K, 70 CRI (27K7) ⑤	120-277 (UNV)
	Type 3 (T3)	32 (32L)	1050 (1)	2700K, 80 CRI (27K8) ① ⑤	340-480 (HV)
	Type 4 (T4)	48 (48L)		3000K, 70 CRI (30K7) ⑤	
	Type 5 (T5)	64 (64L)		3000K, 80 CRI (30K8) ① ⑤	
				3500K, 80 CRI (35K8)	
			4000K, 70 CRI (40K7)		
			4000K, 80 CRI (40K8) ①		
			5000K, 70 CRI (50K7)		
			5000K, 80 CRI (50K8) ①		

Config.	Color	Options	Pole Height
Single (SGL) 	Bronze Textured (BRZ)	Nema 7-Pin Receptacle (PE7) ②	20' (20)
Double (D-180) 	White Textured (WHT)	Photocell (PC) ②	22' (22)
MPF Triple (TRI) ② 	Smooth White Gloss (SWT)	FSP-211 with Motion Sensor (FSP-20) ②	24' (24)
MPF Quad (QD) ② 	Silver Textured (SVR)	9'-20" Heights (FSP-40) ②	26' (26) ③
MPF (MPF) ② 	Black Textured (BLK)	21'-40' Heights	No Pole (NO)
	Smooth Black Gloss (SBK)	Marine Grade Finish (MGF)	Aluminum Pole .250 Wall Comes With 12" Anchor Base 1" Thick, 1" Anchor Bolts
	Graphite Textured (GPH)	House Side Shield (HSS)	
	Grey (GRY)	Rotated Optic Left (ROL)	
	Custom (CS)	Rotated Optic Right (ROR)	
		No Options (NO)	

Notes:

- ① Consult Factory For Lead Time. Consult Factory For 90 CRI Requests.
- ② MPF Mid Pole Fixture. Consult Factory
- ③ Only Available When Ordering NLS Pole
- ④ Universal Voltage 120-277
- ⑤ 3000k or warmer must be selected to meet International Dark-Sky Association certification.
- ⑥ Consult Factory for 26' or above requests.

ELECTRICAL

- 120-277 Volts (UNV) or 347-480 Volts (HV)
- 0-10V dimming driver
- Driver power factor at maximum load is $\geq .95$, THD maximum load is 15%
- LED Drivers Ambient Temp. Min is -40°C and Ambient Temp. Max ranges from 50°C to 55°C and, in some cases, even higher. Consult the factory for revalidation by providing the fixture catalog string before quoting and specifying it.
- All drivers, controls, and sensors housed in enclosed compartment
- CRI 70, 80, or 90
- Color temperatures: 2700K, 3000K, 3500K, 4000K, 5000K
- Surge Protection: 20KA supplied as standard.

OPTIONS

- NEMA 7-Pin Receptacle (PE7). Only available when ordering NLS pole.
- PHOTO CELL (PC)
- DIMMING CONTROL (FSP-20) (FSP-40)
- MARINE GRADE FINISH (MGF)—A multi-step process creating protective finishing coat against harsh environments. Chemically washed in a 5 stage cleaning system. Pre-baked, Powder coated 3-5 mils of Zinc Rich Super Durable Polyester Primer. Oven Baked. Finished Powder Coating of Super Durable Polyester Powder Coat 3-5 mil thickness.
- SHIELD (HSS)—House Side Shield is designed for full property line cut-off.
- ROTATED OPTICS (ROL) (ROR)

CONTROL OPTIONS

FSP-211 with Motion Sensor (FSP-XX)—Passive infrared (PIR) sensor providing multi-level control based on motion/daylight contribution.

- All control parameters adjustable via wireless configuration remote storing and transmitting sensor profiles.
- FSP-20 mounting heights 9-20 feet
- FSP-40 mounting heights 21-40 feet.
- Includes 5 dimming event cycles, 0-10V dimming with motion sensing, re-programmable in the field.
- Motion sensor mounted to access cover
- FSIR-100 commissioning remote is required to change sensor settings. Please contact factory for ordering.

• NEMA 7-PIN RECEPTACLE (PE7)—An ANSI C136.41-2013 receptacle provides electrical and mechanical interconnection between photo control cell and luminaire. Dimming receptacle available two or four dimming contacts supports 0-10 VDC dimming methods or Digital Addressable Lighting Interface (DALI), providing reliable power interconnect.

CONSTRUCTION

- Extruded Aluminum
- Internal cooling fins
- Corrosion resistant external hardware
- One-piece silicone gasket ensures water tight seal for electronics compartment
- Two-piece silicone Micro Optic system ensures IP67 seal around each PCB

FINISH

- 3-5 mils electrostatic powder coat.
- NLS Lighting standard high-quality finishes prevent corrosion and protects against extreme environmental conditions

WARRANTY

Five-year limited warranty for drivers and LEDs.

OPTICS

Silicone optics high thermal stability and light output provide higher powered LEDs with minimized lumen depreciation. UV stability with scratch resistance increases exterior application durability. Silicone optics do not yellow, crack or brittle over time

LISTINGS

- Certified to UL 1598
- UL 8750
- CSA C22.2 No. 250.0
- IP65/ IP67 Rated
- IK10 Rated

DIMENSIONS

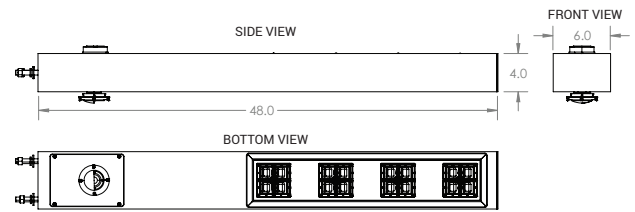

HOUSE SIDE SHIELD

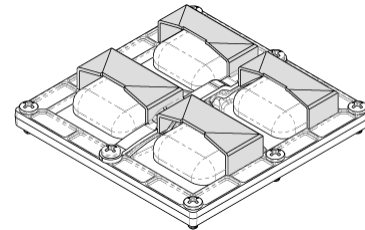

FSP-211

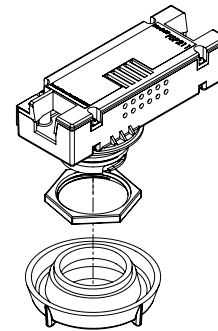

Motion Sensor Placement

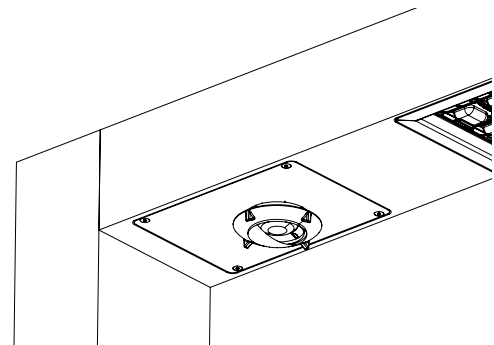

The information and specifications on this document are subject to change without any notification. All values are design, nominal, typical or prorated values when measured under internal and external laboratory conditions.

NLS
LIGHTING

701 Kingshill Place, Carson, CA 90746
P: (310) 341-2037

nslighting.com

IES DISTRIBUTIONS

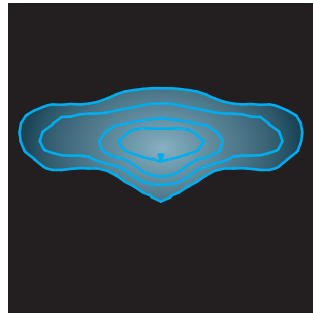
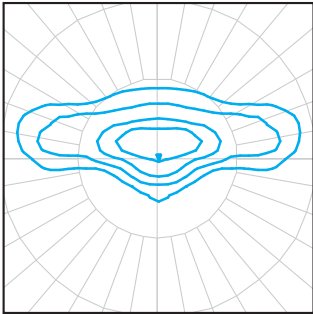

T2 Optic

The Type II distribution is used for narrow pathways and trails, narrow entrances of shopping centers, parking lots and office complex's.

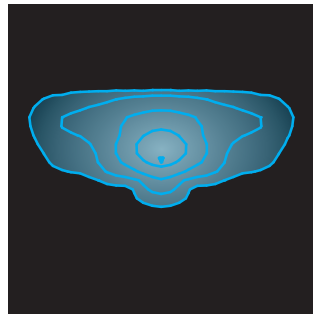
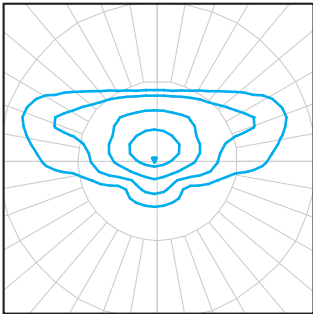

T3 Optic

The type III distribution is meant for roadway lighting, general parking areas and other areas where a larger area of lighting is required. Type III lighting needs to be placed to the side of the area, allowing the light to project outward and fill the area. This produces a filling light flow.

Type III light distributions have a preferred lateral width of 40 degrees. This distribution is intended for luminaires mounted at or near the side of medium width roadways or areas, where the width of the roadway or area does not exceed 2.75 times the mounting height.

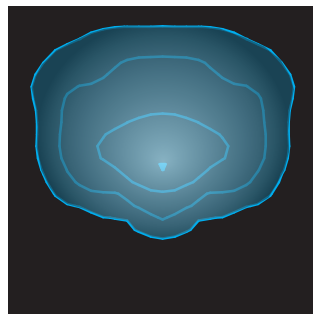
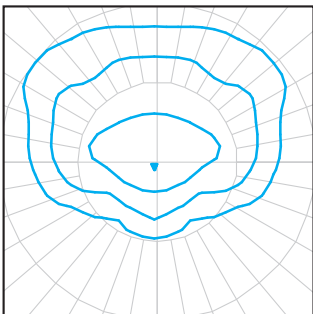

T4 Optic

The type IV distribution produces a semicircular light meant for mounting on the sides of buildings and walls. It's best for illuminating the perimeter of parking areas and businesses. The intensity of the Type IV lighting has the same intensity at angles from 90 degrees to 270 degrees.

Type IV light distributions have a preferred lateral width of 60 degrees. This distribution is intended for side-of-road mounting and is generally used on wide roadways where the roadway width does not exceed 3.7 times the mounting height.

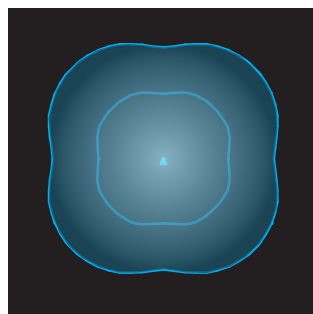
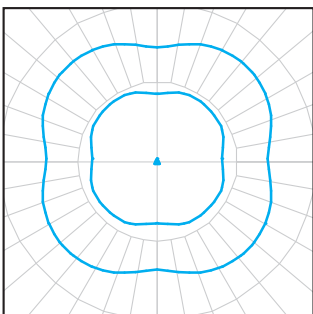

T5 Optic - Symmetrical

Type V produces a symmetrical distribution that has the same intensity at all angles. This distribution has a uniform symmetry of candlepower that is essentially the same at all lateral angles. It is meant for large, commercial parking lot lighting as well as areas where sufficient, evenly distributed light is necessary

SILICONE OPTICS

NLS Lighting Silicone Micro Optical System technology takes quality and performance to the highest level. Vandal resistant, superior clarity—Micro Optics have become the best and lasting solution in the industry.

BENEFITS

- Produces superior 96% clarity
- Heat resistant to 150° C, 50% higher than acrylic
- Ecologically friendly—no glare
- Vandal-resistant
- Does not brittle, crack, or yellow over time

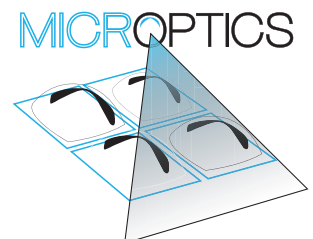

OPTICAL CONFIGURATIONS

Rotatable Optics (ROR) Rotated Right, (ROL) Rotated Left options available. Optics field and factory rotatable.



TRAC 5 LUMEN CHART

PART NUMBER	T2	LM/W	BUG	T3	LM/W	BUG	T4	LM/W	BUG	T5	LM/W	BUG	WATTS
TRC-5-16L-7-30K7	4,385	122	B1-U0-G1	4,409	122	B1-U0-G1	4,409	122	B1-U0-G1	4,495	125	B3-U0-G1	36
TRC-5-16L-7-40K7	4,604	128	B1-U0-G1	4,630	129	B1-U0-G1	4,630	129	B1-U0-G1	4,720	131	B3-U0-G1	36
TRC-5-16L-7-50K7	4,604	128	B1-U0-G1	4,630	129	B1-U0-G1	4,630	129	B1-U0-G1	4,720	131	B3-U0-G1	36
TRC-5-16L-1-30K7	6,022	108	B1-U0-G1	6,056	108	B1-U0-G1	6,056	108	B1-U0-G1	6,174	110	B3-U0-G1	56
TRC-5-16L-1-40K7	6,323	113	B1-U0-G1	6,359	114	B1-U0-G1	6,359	114	B1-U0-G1	6,482	116	B3-U0-G1	56
TRC-5-16L-1-50K7	6,323	113	B1-U0-G1	6,359	114	B1-U0-G1	6,359	114	B1-U0-G2	6,482	116	B3-U0-G1	56
TRC-5-32L-7-30K7	8,770	124	B2-U0-G2	8,819	124	B2-U0-G2	8,819	124	B2-U0-G2	8,990	127	B3-U0-G2	71
TRC-5-32L-7-40K7	9,208	130	B2-U0-G2	9,259	130	B2-U0-G2	9,259	130	B2-U0-G2	9,439	133	B3-U0-G2	71
TRC-5-32L-7-50K7	9,208	130	B2-U0-G2	9,259	130	B2-U0-G2	9,259	130	B2-U0-G2	9,439	133	B3-U0-G2	71
TRC-5-32L-1-30K7	11,797	111	B2-U0-G2	11,863	112	B2-U0-G2	11,863	112	B2-U0-G2	12,094	114	B4-U0-G2	106
TRC-5-32L-1-40K7	12,387	117	B2-U0-G2	12,456	118	B2-U0-G2	12,456	118	B2-U0-G2	12,698	120	B4-U0-G2	106
TRC-5-32L-1-50K7	12,387	117	B2-U0-G2	12,456	118	B2-U0-G2	12,456	118	B2-U0-G2	12,698	120	B4-U0-G2	106
TRC-5-48L-7-30K7	13,154	126	B2-U0-G2	13,228	127	B3-U0-G3	13,228	127	B3-U0-G3	13,485	130	B4-U0-G2	104
TRC-5-48L-7-40K7	13,812	133	B2-U0-G2	13,889	134	B3-U0-G3	13,889	134	B3-U0-G3	14,159	136	B4-U0-G2	104
TRC-5-48L-7-50K7	13,812	133	B2-U0-G2	13,889	134	B3-U0-G3	13,889	134	B3-U0-G3	14,159	136	B4-U0-G2	104
TRC-5-48L-1-30K7	17,360	111	B3-U0-G3	17,457	112	B3-U0-G3	17,457	112	B3-U0-G3	17,796	114	B4-U0-G2	156
TRC-5-48L-1-40K7	18,228	117	B3-U0-G3	18,330	117	B3-U0-G3	18,330	117	B3-U0-G3	18,686	120	B4-U0-G2	156
TRC-5-48L-1-50K7	18,228	117	B3-U0-G3	18,330	117	B3-U0-G3	18,330	117	B3-U0-G3	18,686	120	B4-U0-G2	156
TRC-5-64L-7-30K7	17,539	129	B3-U0-G3	17,637	130	B3-U0-G3	17,637	130	B3-U0-G3	17,980	132	B4-U0-G2	136
TRC-5-64L-7-40K7	18,416	135	B3-U0-G3	18,519	136	B3-U0-G3	18,519	136	B3-U0-G3	18,879	139	B4-U0-G2	136
TRC-5-64L-7-50K7	18,416	135	B3-U0-G3	18,519	136	B3-U0-G3	18,519	136	B3-U0-G3	18,879	139	B4-U0-G2	136
TRC-5-64L-1-30K7	22,627	110	B3-U0-G3	22,753	111	B3-U0-G3	22,753	111	B3-U0-G3	23,195	113	B5-U0-G3	205
TRC-5-64L-1-40K7	23,758	116	B3-U0-G3	23,891	117	B3-U0-G3	23,891	117	B3-U0-G3	24,355	119	B5-U0-G3	205
TRC-5-64L-1-50K7	23,758	116	B3-U0-G3	23,891	117	B3-U0-G3	23,891	117	B3-U0-G3	24,355	119	B5-U0-G3	205

3000k or warmer must be selected to meet International Dark-Sky Association certification.

TRAC 5 LUMEN CHART HSS

PART NUMBER	T2 HSS	LM/W	BUG	T3 HSS	LM/W	BUG	T4 HSS	LM/W	BUG	WATTS
TRC-5-16L-7-30K7	3,227	90	B1-U0-G1	3,120	87	B0-U0-G1	3,018	84	B0-U0-G1	36
TRC-5-16L-7-40K7	3,389	94	B1-U0-G1	3,276	91	B0-U0-G1	3,169	88	B0-U0-G1	36
TRC-5-16L-7-50K7	3,389	94	B1-U0-G1	3,276	91	B0-U0-G1	3,169	88	B0-U0-G1	36
TRC-5-16L-1-30K7	4,433	79	B1-U0-G1	4,285	77	B0-U0-G1	4,145	74	B1-U0-G1	56
TRC-5-16L-1-40K7	4,654	83	B1-U0-G1	4,499	80	B1-U0-G1	4,353	78	B1-U0-G1	56
TRC-5-16L-1-50K7	4,654	83	B1-U0-G1	4,499	80	B1-U0-G1	4,353	78	B1-U0-G1	56
TRC-5-32L-7-30K7	6,454	91	B1-U0-G1	6,239	88	B1-U0-G2	6,036	85	B1-U0-G2	71
TRC-5-32L-7-40K7	6,777	95	B1-U0-G2	6,551	92	B1-U0-G2	6,338	89	B1-U0-G2	71
TRC-5-32L-7-50K7	6,777	95	B1-U0-G2	6,551	92	B1-U0-G2	6,338	89	B1-U0-G2	71
TRC-5-32L-1-30K7	8,683	82	B1-U0-G2	8,394	79	B1-U0-G2	8,120	77	B1-U0-G2	106
TRC-5-32L-1-40K7	9,117	86	B1-U0-G2	8,813	83	B1-U0-G2	8,526	80	B1-U0-G2	106
TRC-5-32L-1-50K7	9,117	86	B1-U0-G2	8,813	83	B1-U0-G2	8,526	80	B1-U0-G2	106
TRC-5-48L-7-30K7	9,682	93	B1-U0-G2	9,359	90	B1-U0-G2	9,054	87	B1-U0-G2	104
TRC-5-48L-7-40K7	10,166	98	B1-U0-G2	9,827	94	B1-U0-G2	9,507	91	B1-U0-G2	104
TRC-5-48L-7-50K7	10,166	98	B1-U0-G2	9,827	94	B1-U0-G2	9,507	91	B1-U0-G2	104
TRC-5-48L-1-30K7	12,777	82	B1-U0-G2	12,352	79	B1-U0-G2	11,949	77	B1-U0-G2	156
TRC-5-48L-1-40K7	13,416	86	B1-U0-G2	12,969	83	B1-U0-G2	12,547	80	B1-U0-G2	156
TRC-5-48L-1-50K7	13,416	86	B1-U0-G2	12,969	83	B1-U0-G2	12,547	80	B1-U0-G2	156
TRC-5-64L-7-30K7	12,909	95	B1-U0-G2	12,479	92	B1-U0-G2	12,073	89	B1-U0-G2	136
TRC-5-64L-7-40K7	13,554	100	B2-U0-G2	13,103	96	B1-U0-G2	12,676	93	B1-U0-G2	136
TRC-5-64L-7-50K7	13,554	100	B2-U0-G2	13,103	96	B1-U0-G2	12,676	93	B1-U0-G2	136
TRC-5-64L-1-30K7	16,653	81	B2-U0-G2	16,099	79	B1-U0-G2	15,575	76	B1-U0-G3	205
TRC-5-64L-1-40K7	17,486	85	B2-U0-G2	16,904	82	B1-U0-G3	16,353	80	B1-U0-G3	205
TRC-5-64L-1-50K7	17,486	85	B2-U0-G2	16,904	82	B1-U0-G3	16,353	80	B1-U0-G3	205

MODEL	WIDTH	DEPTH	LENGTH	WEIGHT	EPA	SGL	DBL
TRAC - 5	6"	4"	48"	33		1.6	3.2

Lumen Maintenance Data							
Ambient Temperature	Drive Current	L90 Hours*	L70 Hours**	30,000 Hours*	50,000 Hours*	60,000 Hours*	100,000 Hours**
25°C	Up to 700mA	58,000	173,000	95.7%	91.6%	89.6%	82.1%
	1050mA	48,000	143,000	94.3%	89.5%	87.2%	78.5%
*Reported extrapolations per IESNA TM-21				**Projected extrapolations per IESNA TM-21			



701 Kingshill Place, Carson, CA 90746
P: (310) 341-2037

nslighting.com

TRAC POLE RECTANGULAR ALUMINUM POLE

SHAFT

Rectangular Aluminum Pole (RAP) shaft (.250 Wall) is 6061 T6 Extruded Aluminum, 4 X 6 inch to provide a seamless transition into the Trac fixture. Poles have ground lug welded inside hand-hole opposite side of the pole extrusion. Pole Extrusion is conjoined to Anchor Base by welding internal and external to pole shaft. For custom configuration consult Factory.

ANCHOR BOLTS

All anchor bolts are fully hot dipped galvanized and come with two galvanized nuts and washers per bolt. Anchor bolts are not included for Custom Bolt Circle. Anchor Bolts are "J" style, with a 4" hook at the end for added strength. 1" Anchor Bolts are 1" diameter x 36" long with a 4" long "J" hook.

ANCHOR BASE

Base plates are machined from 6061 Aluminum, 12" square, 1" thick with 1" anchor bolts.

HAND HOLE COVER AND POLE CAP

All poles come with removable machined aluminum pole cap. All poles caps are powder coated to match the pole. All base covers are made of aluminum and powder coated to match the pole. Hand Hole is constructed of 3"x 5" rectangular aluminum tubing which is welded to pole shaft for added strength. Hand Hole covers are provided with internal bridge support and also powder coated to match pole finish.

FINISH

All poles have minimum 3 to 5 mils powder coat finish. All poles are sandblasted prior to powder coat application.

RECTANGULAR ALUMINUM POLE DETAIL

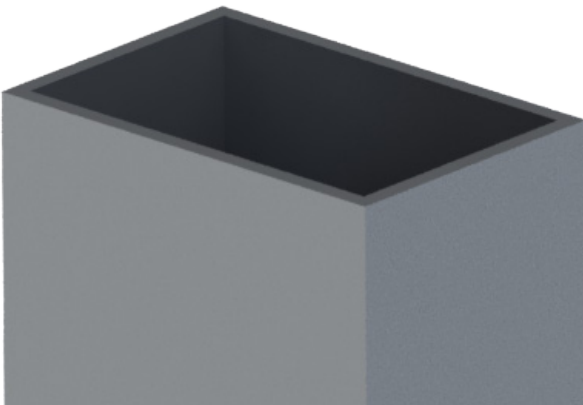

- *Anchor Bolts are NOT included with Custom Bolt Circle.
- *Do NOT pour concrete referencing this drawing. Consult Factory.
- *Must Specify 4-Bolt Pattern.

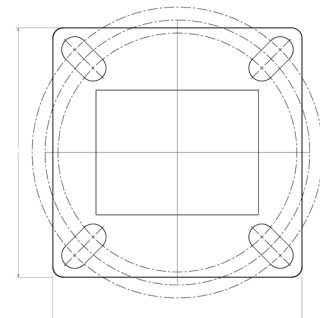
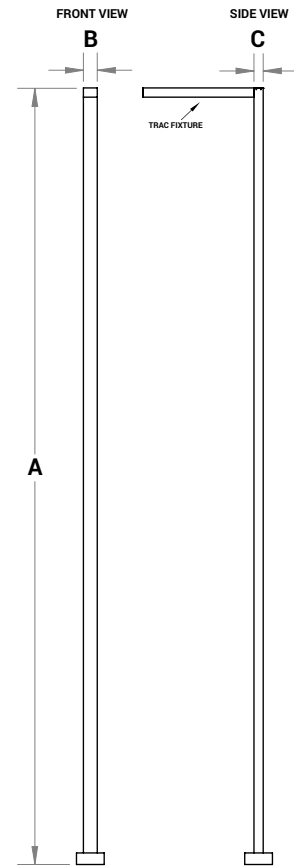

12" Base

*Consult Factory for Bolt Circle Template

DIMENSION	RAP
A	20-24 ft. or Custom Height
B	6 in.
C	4 in.