

# VERTICAL SOLAR PV POLES

---

USOL-20001  
2x100w

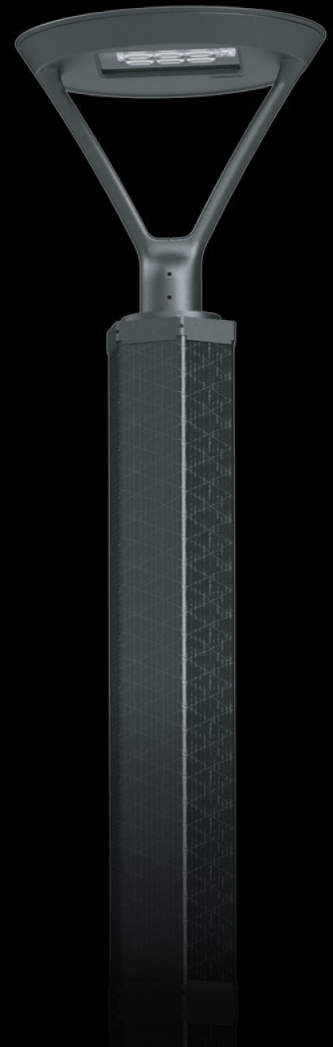
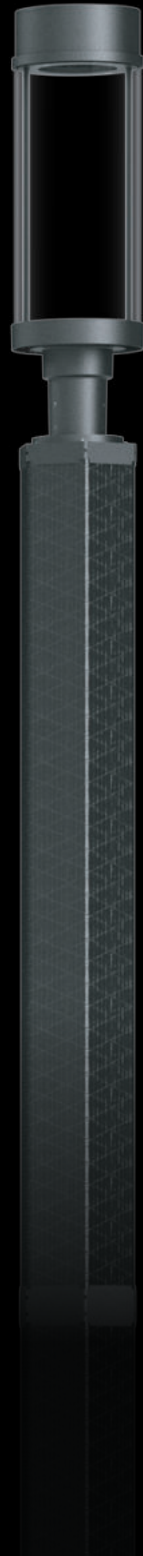
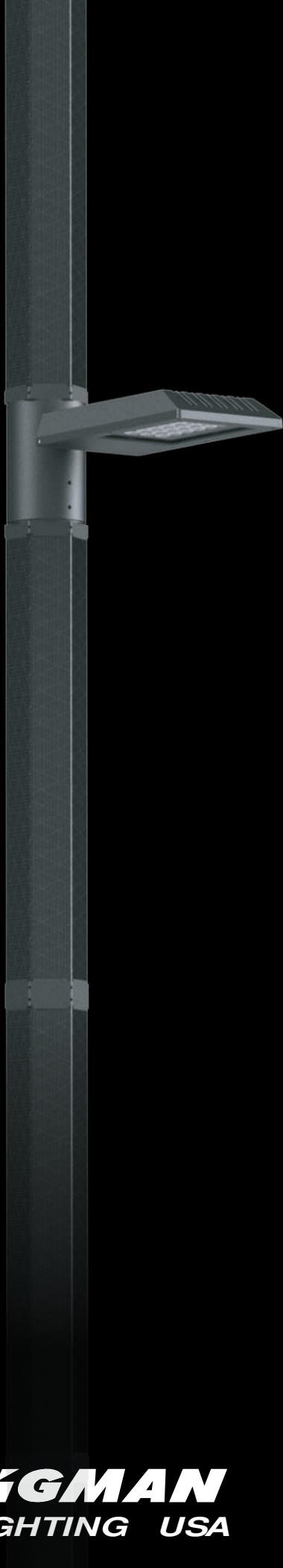

**LIGMAN**  
LIGHTING USA

### Powder coated galvanized steel light column clad with hexagonal vertical solar PV panels

#### Pole & luminaire features

- Solar modules consist of monocrystalline high-efficiency photovoltaic cells
- Lithium Iron Phosphate (LiFePO4) battery
- Dimming range 0-100%
- Different dimming scenarios are available: Step dimming, Dusk to dawn, Five-stage night mode, Custom hours
- Optional integrated temperature & motion sensors
- Remote solar charger programmer can be ordered as an accessory

Product code	System	Solar module power	Battery 12V 16.5Ah	20w Luminaire		30w Luminaire		40w Luminaire		60w Luminaire		80w Luminaire	
				Luminaires operating 100%	Standard dimming	Luminaires operating 100%	Standard dimming	Luminaires operating 100%	Standard dimming	Luminaires operating 100%	Standard dimming		
Estimated run time for luminaire from fully charged batteries													
SOL-20001	12Vdc	2X100 W	2X16.5Ah	8.7 Hr.	12.6Hr.	-	-	3.8 Hr.	5.4 Hr.	-	-	-	-

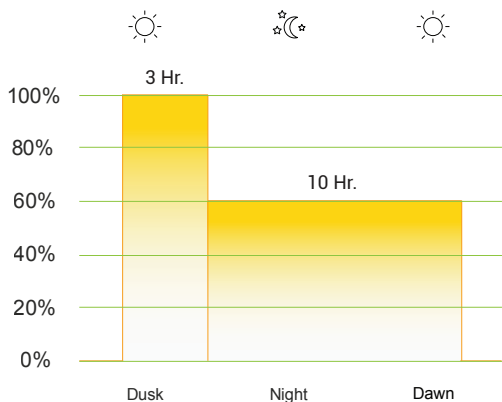

Solar module power	2x100 W
Battery	12V 2x16.5Ah
Pole Diameter	Ø8.5"
Luminaires operating 100 %	20 W (8-9 hours) 40 W (3-4 hours)
Tenon	2.99"
Steel Pole Wall Thickness	.15"
Height	14.2'
Assembled Weight	301 lbs

Time & dimming settings are set with the remote solar charger programmer

Standard: 2 stage step-dimming, occupancy dimming and sensor.

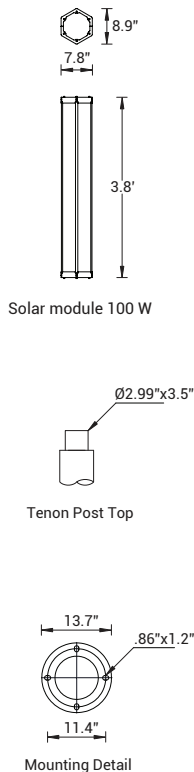
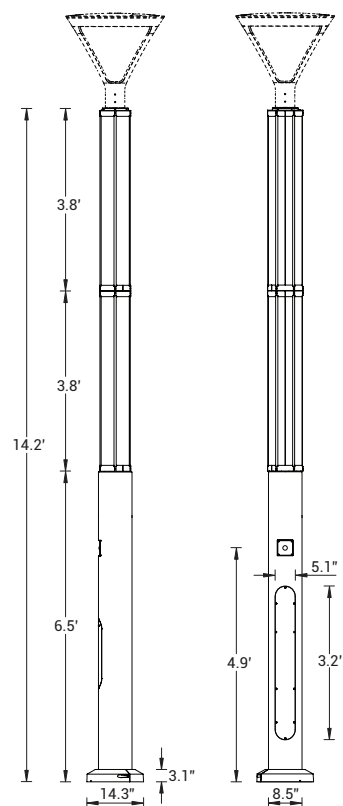

#### Luminaire options using 20w or 40w LEDs

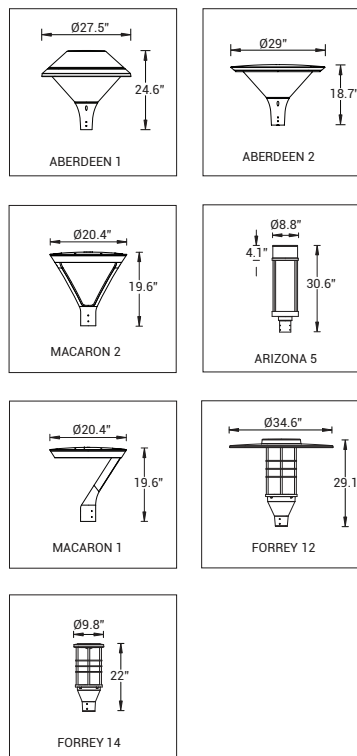

Seamless vertical solar PV module integration

Seamless vertical integration is a clean efficient method to integrate solar photovoltaic technology into column lighting systems. Using this method, large flat solar panels are not fixed on top of the lighting column or system, but instead are placed around the lighting pole itself. This seamlessly integrates the technology aesthetically without compromising the efficiency, adding value to both designers and end users.

Vertical integration is more wind-resistant, reducing wind-loads and minimising the need for more expensive pole foundations. It also provides a reduced maintenance burden with the reduction of dirt build up on the photovoltaic surfaces requiring both less frequent and easier cleaning. The vertical wrap-around panels receive light more evenly and efficiently from the sun and sky during the course of daylight hours, even in darker climates and seasons.



360° Full day charging

6 slim solar sections are fixed tightly onto a hexagon frame which ensures 50% of solar panel will face sunshine at any time of the day no onsite orientation is needed.



Modular installation

The cylindrical solar PV module is based on a modular design concept for easy installation and maintenance.



Patented design

The cylindrical solar PV module is designed based on advanced concepts and manufactured to high standards. PCT pre-registration was processed in 180 countries to protect keymarkets.



Design aesthetics

The module system is the real answer to design aesthetics, providing a compact and fully integrated green energy solution to the pole.

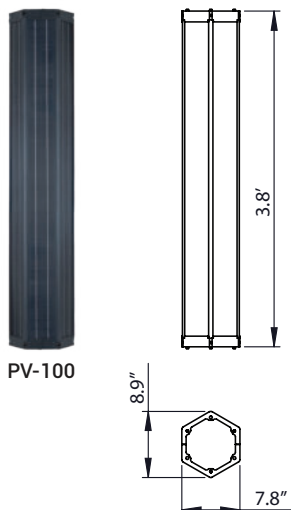

PV-100

Hidden compartment for batteries

The pole is supplied with a compartment and shelving to facilitate the installation of batteries and controller.

To simplify installation and maintenance the controller and batteries are installed in the base section of the pole and are hidden with a flush-mounted cover that follows the contour of the pole and secured with tamper-proof screws.

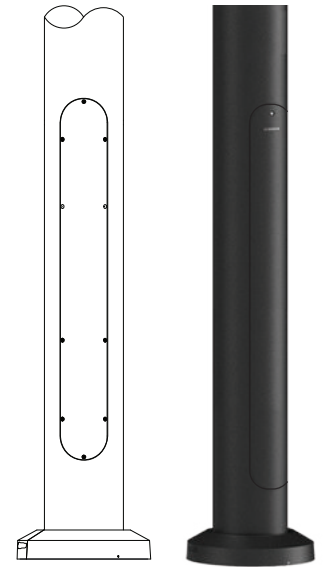

Strong wind resistance

The cylindrical design reduces the wind load area and each module is directly fastened to the pole by 12 screws for better wind resistance. Ideal for very windy regions.



Anti snow covering

Cylindrical solar PV modules are mounted vertically, preventing build up of snow and dirt. This ensures that enough power can be generated even in very snowy climates.



Easy to clean

Less dust will fall on the surface than on a regular solar panel. Maintenance workers can clean it easily standing on the ground with an extending low-pressure hose brush or spray cleaner. This results in higher work efficiency and reduced maintenance cost.

Model number	PV-100	
Maximum power	100 W	
Maximum power voltage	18V	36V
Maximum power current	5.56A	2.78A
Cell type	Mono - Crystalline	
Material	Aluminum + Tempered glass	
International protection standard rate	IP65	
Solar cell efficiency	>20.5%	
Operating temperature	-40°C ~ +80°C	
Rated life-time	>20 years	
Weight	38.5 lbs	
Warranty:		
Solar array & Ligman manufactured product	5 Years	
Charge Controller	3 Years	
Battery (Made in USA)	2000 Cycles. 5 year back-to-back manufacturer warranty	

### Lithium Iron phosphate (LiFePO4) battery

- Using lithium iron phosphate cell technology, superior safety
- Thousands of cycles, 100% DOD, under normal conditions.
- Built-in automatic protection for over-charge, over discharge, over current and over temperature.
- Free of maintenance
- Internal cell balancing
- Lighter weight: About 40% ~ 50% of the weight of a comparable lead acid battery
- Wider temperature range: -20°F ~ 120°F



### General specifications

Size	7.12" x 3.03" x 6.57"
Weight	6.4lbs
Voltage & Capacity	12 V 23 Ah 276 Wh
Storage Capacity	23 Ampere Hours
Terminals	F12 Terminals. Bolt Size - M5
Lifespan/Lifecycles	Up to 80% capacity for 2,000 cycles in recommended conditions.
Operating Temperature	-20°F min, +120°F max environmental operating temps. Avoid below 32°F
Discharge	24 A max continuous 60 A max 10-second pulse 9.0 V max discharge 11.0 V max recommended discharge
Charge	15 A max
Safe & Reliable	Includes active BMS protection circuit that handles cell balancing, low voltage cutoff, high voltage cutoff, short circuit protection and temperature protection for increased performance and longer life.

### Test performance of LiFe PO4 batteries

Different depth of discharge (DOD) discharge cycle life curve @ 25° C (77° F)

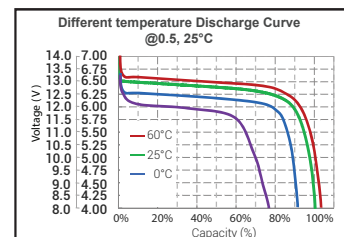
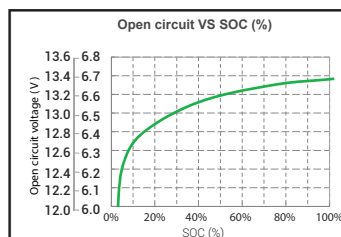
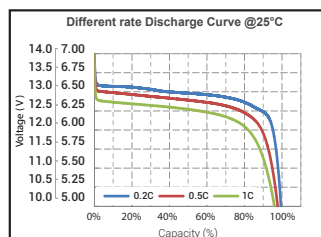
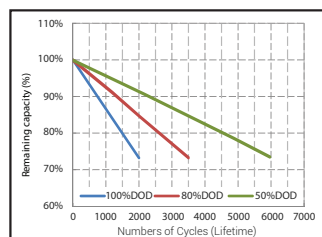

Solar charge controller

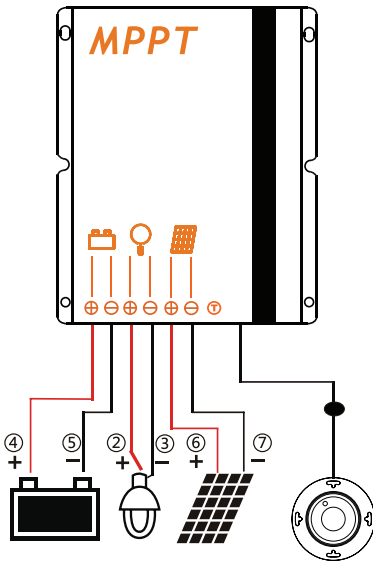

Innovative max power point tracking (MPPT) technology, tracking efficiency >99%



Full digital technology, high charge conversion efficiency up to 97%



Full digital technology, high discharge conversion efficiency up to 96%



Precision constant current control supports from 50mA up to 100mA



5 timed dimming stages can be programmed from 0% to 100% dimming levels



Remote control operation



Dimming levels adapt to low voltage battery conditions



Automatic recognition of system voltage



Motion detection option adapting dimming levels based on pedestrian needs



External temperature sensor



IP67, Strong and durable aluminum housing



Full automatic electronic protection

Remote solar charger programmer

LIGMAN provides programmable charge controllers that can be set for any desired setting for dusk to dawn pole operation. With timers and/or sensor overrides as required.

Some typical algorithm examples are shown below:

Standard setting type:

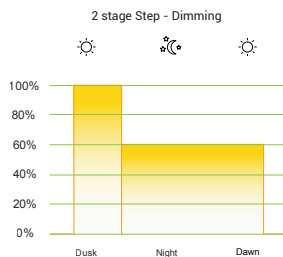

Effective programming distance - Up to 26'

A92291

Custom setting type option:

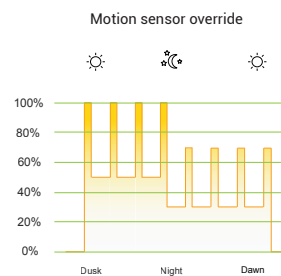
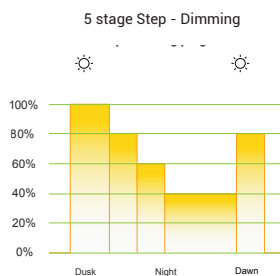
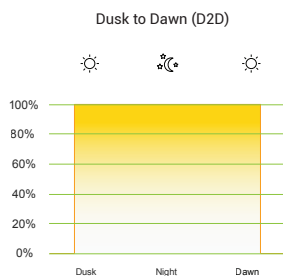

### Motion sensor detection area

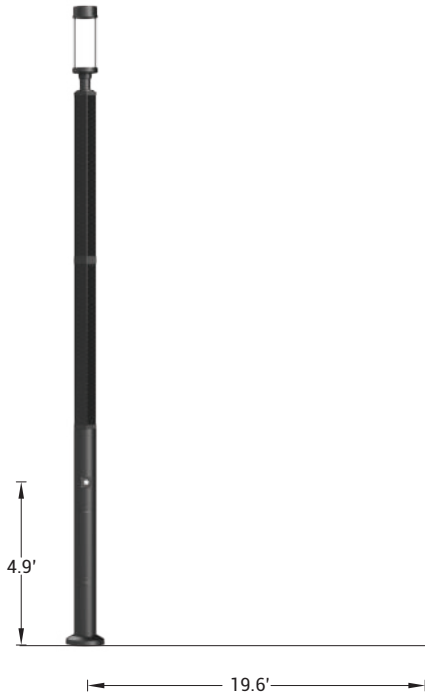

This product can be provided with an occupancy sensor so that in the event of the fixture being in a dim mode, the luminaire can be programmed to go to full brightness for a period of time if movement is detected.

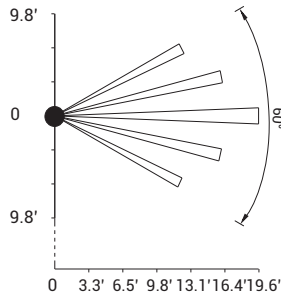

Sensor: Adjustable sensor  
 Time: 10 sec. - 150 sec.  
 Sensitivity 60°

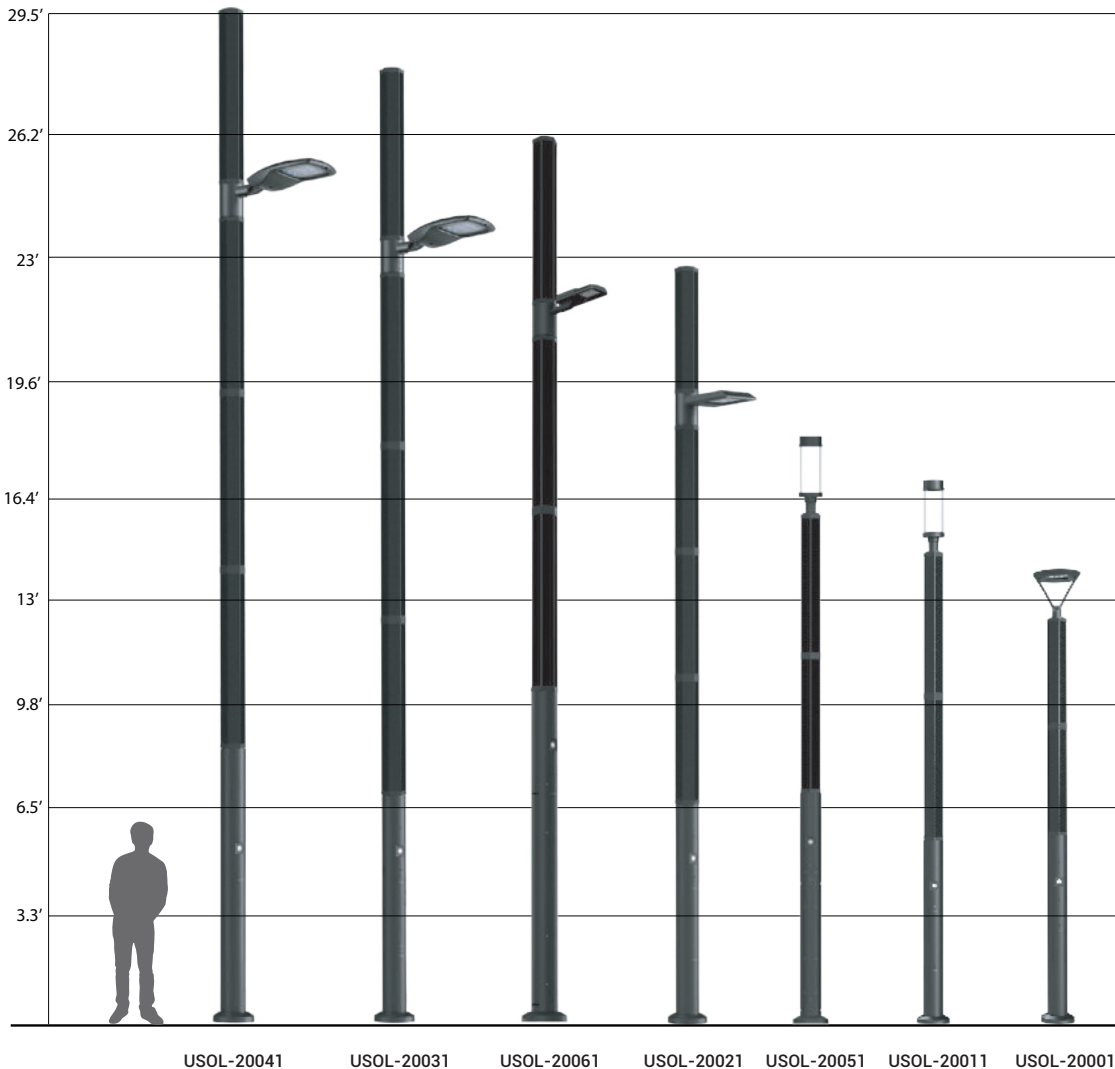

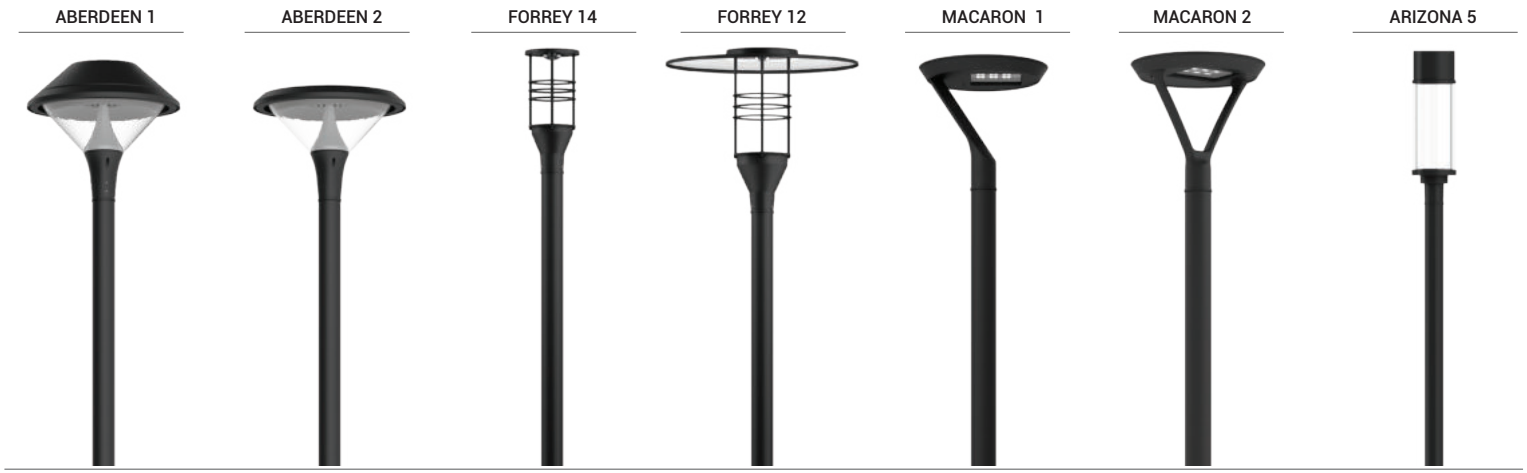

	Product code	Lamp	Wattage	Lumen	EEC	Weight	Beam			Color Temp
							T2	T3	T4	

Post top luminaires										
ABERDEEN 1	UABA-20001-SO-20	24 LED	20 W	2738 lm	A++	25.3 lb	142°x59°	142°x72°	102°x63°	W 27   30   40
	UABA-20001-SO-40	24 LED	40 W	5477 lm	A++	25.3 lb	142°x59°	142°x72°	102°x63°	W 27   30   40
ABERDEEN 2	UABA-20011-SO-20	24 LED	20 W	2738 lm	A++	23.1 lb	142°x59°	142°x72°	102°x63°	W 27   30   40
	UABA-20011-SO-40	24 LED	40 W	5477 lm	A++	23.1 lb	142°x59°	142°x72°	102°x63°	W 27   30   40
FORREY 14	UFOR-20022-SO-20	1 COB	20 W	1907 lm	A+	29.7 lb	140°x100°	132°x103°	137°x117°	W 27   30   40
	UFOR-20022-SO-40	1 COB	40 W	3814 lm	A+	29.7 lb	140°x100°	132°x103°	137°x117°	W 27   30   40
FORREY 12	UFOR-20042-SO-20	1 COB	20 W	1907 lm	A+	37.4 lb	140°x100°	132°x103°	137°x117°	W 27   30   40
	UFOR-20042-SO-40	1 COB	40 W	3814 lm	A+	37.4 lb	140°x100°	132°x103°	137°x117°	W 27   30   40
MACARON 1	UMC-20002-SO-20	24 LED	20 W	2550 lm	A++	29.7 lb	136°x51°	119°x86°	102°x73°	W 27   30   40
	UMC-20002-SO-40	24 LED	40 W	5100 lm	A++	29.7 lb	136°x51°	119°x86°	102°x73°	W 27   30   40
MACARON 2	UMC-20012-SO-20	24 LED	20 W	2550 lm	A++	29.7 lb	136°x51°	119°x86°	102°x73°	W 27   30   40
	UMC-20012-SO-40	24 LED	40 W	5100 lm	A++	29.7 lb	136°x51°	119°x86°	102°x73°	W 27   30   40
ARIZONA 5	UAR-21052-SO-20	16 LED	20 W	2101 lm	A++	17.8 lb	142°x52°	137°x65°	93°x64°	W 27   30   40
	UAR-21052-SO-40	16 LED	40 W	4201 lm	A++	17.8 lb	142°x52°	137°x65°	93°x64°	W 27   30   40



LUMINAIRE/POLE COLOR

- 01 - BLACK RAL 9011
- 02 - DARK GREY RAL 7043
- 03 - WHITE RAL 9003
- 04 - METALLIC SILVER RAL 9006
- 05 - MATTE SILVER RAL 9006
- 06 - LIGMAN BRONZE
- 07 - CUSTOM RAL

ACCESSORY

- A92291 - REMOTE SOLAR CHARGER PROGRAMMER
- OCC - POLE MOUNTED OCCUPANCY SENSOR [SEE DRAWING FOR POSITION]

The solar calculations done by Ligman for project locations are subject to approval and have been made with information provided by others at time of request Ligman Lighting USA cannot be held responsible for product performance based on inadequate sunlight due to obstructions like structures/ Buildings, Trees /bushes, Hills and/or any other unforeseen environmental condition that may affect the performance of this product.