

# QUAD TBar



Project: \_\_\_\_\_

\_\_\_\_\_

Type: \_\_\_\_\_

\_\_\_\_\_

Notes: \_\_\_\_\_

\_\_\_\_\_

The **QUAD** Luminaire features a Patent-Pending mounting system over the intersection of the ceiling grid. The Quad is a modular Downlight fixture that allows for different configurations based on optical and aesthetic requirements.

Shown: QuadT1-FR-ARW-BRW-CRW-DRW-...



\*FASTSIZE tiles made-to-order through your Armstrong rep. Contact Armstrong for compatible tiles



Patent Pending  
5 Year Warranty

## Ordering Guide



QuadT1							
ARON ID	CEILING TYPE/SHAPE	QUADRANT A	QUADRANT B	QUADRANT C	QUADRANT D	LUMENS PER QUADRANT	
QuadT1 QUAD TBar	FR Flat Grid Round Quadrants	ARW Regressed Lens-Static White ARC Regressed Lens RGBW AX No Quadrant	BRW Regressed Lens-Static White BRC Regressed Lens RGBW BX No Quadrant	CRW Regressed Lens-Static White CRC Regressed Lens RGBW CX No Quadrant	DRW Regressed Lens-Static White DRC Regressed Lens RGBW DX No Quadrant	125	125 Lumens per Quadrant
	DW Drywall Round Quadrants					250	250 Lumens per Quadrant
						400	400 Lumens per Quadrant
						500	500 Lumens per Quadrant
						750	750 Lumens per Quadrant
						1750	1750 Lumens per Quadrant

BEAM		COLOR / CRI		UNV		DM		FINISH		OPTIONS	
				VOLTAGE		DRIVER					
B1	Narrow	27K8	2700K - 80CRI	UNV	120 - 277V	DM	Factory 0-10V Dim 1%	W	White	E5W	5W EM Battery
B2	Medium	30K8	3000K - 80CRI			BT	Blue Tooth	BLK	Black	E10W	10W EM Battery
B3	Wide	35K8	3500K - 80CRI			DMX	DMX	C	Custom Color	CP	Chicago Plenum
B4	Asymmetric	40K8	4000K - 80CRI								
		27K9	2700K - 90CRI								
		30K9	3000K - 90CRI								
		35K9	3500K - 90CRI								
		40K9	4000K - 90CRI								
		RGBW	RGBW - specify color temp of W								

## Ordering Instructions

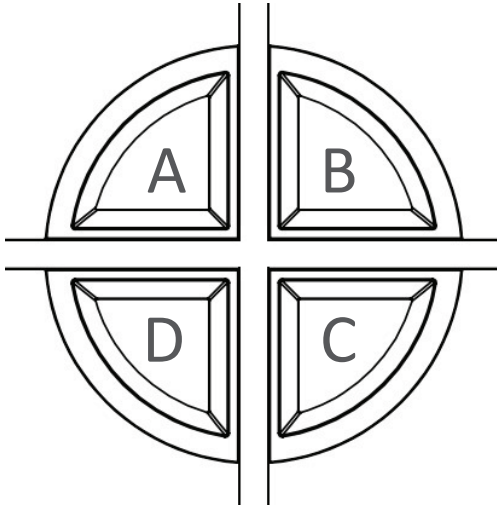

- Match labeled quadrant with corresponding column on ordering guide.
- Notate "R" to use quadrant with regressed lens.
- Notate "X" to omit quadrant from fixture.

**Notes:**

- Coordinate lighting fixture install with ceiling contractor
- Contact your local Armstrong representative for Made-To-Order ceiling tiles. (See page 6)

## Sample Configurations

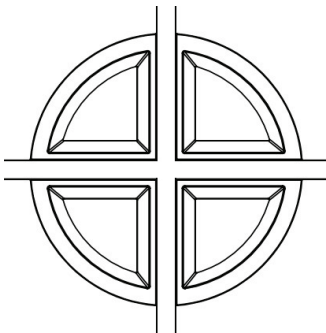

QuadT1-FR-AR-BR-CR-DR

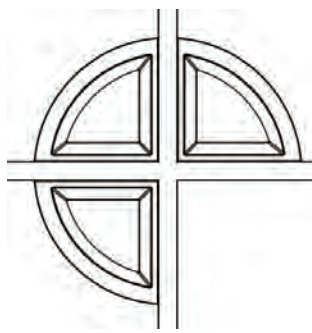

QuadT1-FR-AR-BR-CX-DR

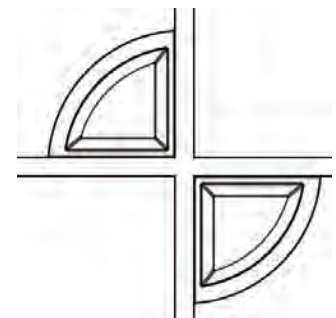

QuadT1-FR-AR-BX-CR-DX

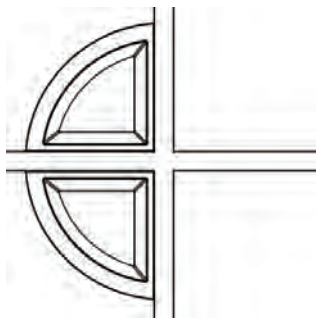

QuadT1-FR-AR-BX-CX-DR

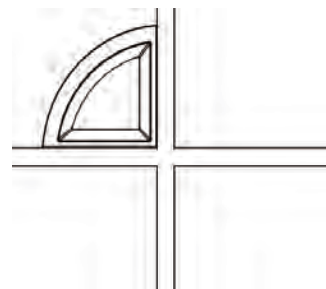

QuadT1-FR-AR-BX-CX-DX

## Housing Types

### Flat Housing



- Notate "FR" in Ordering Guide
- Designed for Flat 9/16" & 15/16" Grids

## Dimensions

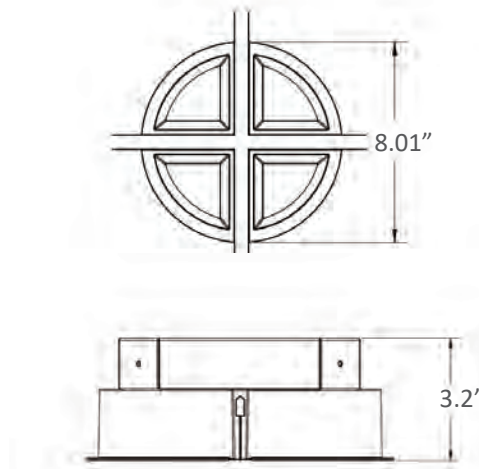

Flat Housing

### Construction

- Cast Aluminum housing
- Powder coated paint
- Galvanized sheet metal components
- Mate with Flat 15/16", 9/16" and Dimensional 9/16" TBars

### Optical

- Symmetric and asymmetric distributions
- Coated Acrylic light guide
- Coated Acrylic diffuser
- Minimum 80 or 90 CRI
- 3000K, 3500K, 4000K
- ≤ 3 SDCM

### Electrical

- Integral high efficiency driver
- 0-10V dimming (1%) standard
- Class 2

### Weight

- 4Q = 10 lbs
- 3Q = 8.5 lbs
- 2Q = 7.0 lbs
- 1Q = 5.5 lbs

# QUAD TBar

## Beam Options

\*Contact factory for custom configurations\*

### 4, 3, 2D, 1 Quadrant Configurations

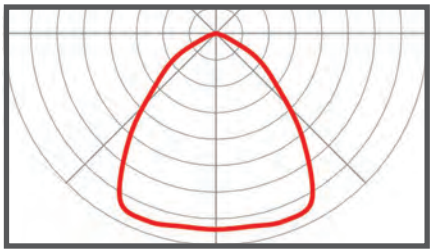
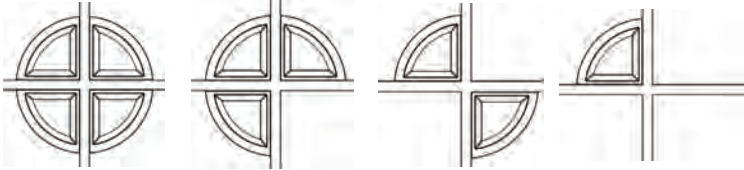

B1 - Narrow

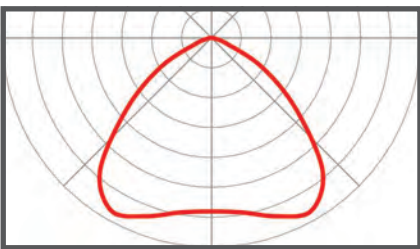

B2 - Medium

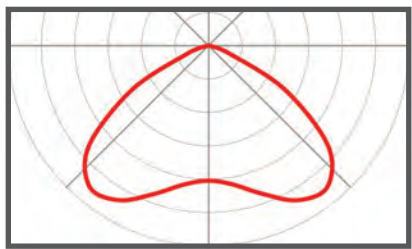

B3- Wide

### 2 Quadrant Parallel

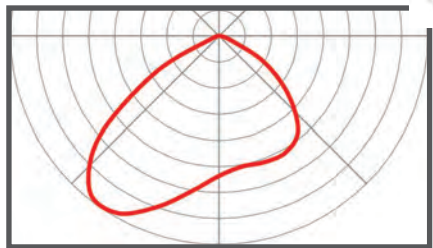

B4- Asymmetric

## Fixture Wattages

Lumens/Fixture	Watts/Fixture
250	3.0
500	6.0
1000	12.0
1500	18.1
2000	24.1

## Bluetooth Technology



With our BubblyNet OEM partnership, realize the power of bluetooth lighting control! Offering wall controllers, integrated fixture sensors, tunable white/ rgbw control. Contact Factory for More Information



## PoE Technology

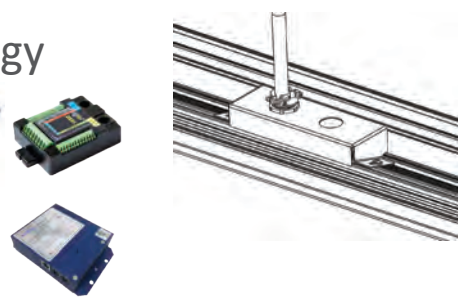

Our Partnerships with Igor and NuLEDs offer PoE Integration using low voltage cat 5, cat 6 cabling. Contact Factory For more Information.



## Model Tested: QuadT1-FR-AR-BR-CR-DR-400-B2-35K8-UNV-DM-W

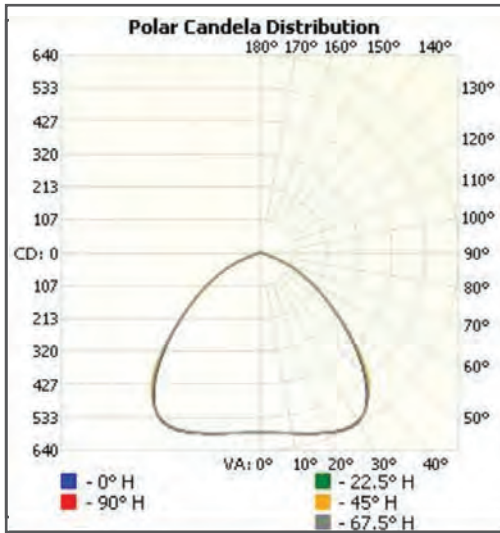

**Configuration:** 4 Quadrant  
**Lumens/Quadrant:** 403  
**Total Lumens:** 1613  
**Input Watts:** 19.77 W  
**Efficacy:** 81.6 lm/W

Vertical Angle	Horizontal Angles				
	0	22.5	45	67.5	90
0	582	582	582	582	582
5	585	585	585	584	585
10	594	593	593	592	593
15	606	606	604	604	606
20	620	620	618	619	621
25	633	632	629	631	633
30	631	629	628	629	632
35	598	598	602	600	599
40	526	530	543	532	528
45	433	437	451	441	437
50	337	340	340	344	340
55	250	256	249	259	253
60	180	189	177	187	182
65	122	124	121	127	122
70	59	67	70	69	60
75	21	22	27	22	21
80	11	11	11	11	11
85	3	3	3	3	3
90	0	0	0	0	0

Zonal Lumens		
Zone	Lumens	% Luminaire
0-10	56.1	3.5
10-20	172.0	10.7
20-30	291.1	18.0
30-40	370.9	23.0
40-50	338.0	20.9
50-60	229.2	14.2
60-70	122.3	7.6
70-80	29.9	1.9
80-90	4.4	0.3

## Model Tested: QuadT1-FR-AR-BX-CX-DR-400-B4-35K8-UNV-DM-W

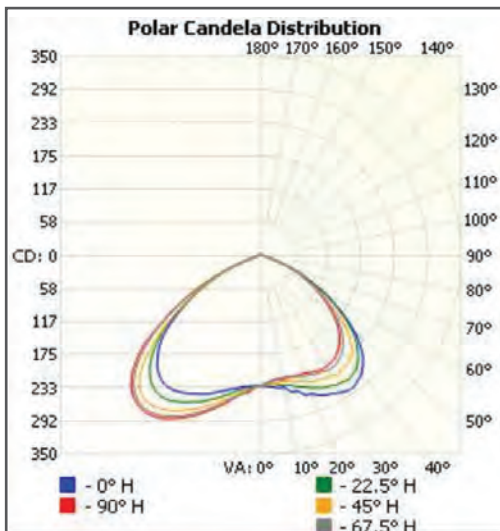

**Configuration:** 2 Quadrant Parallel  
**Lumens/Quadrant:** 422  
**Total Lumens:** 845  
**Input Watts:** 9.76 W  
**Efficacy:** 86.6 lm/W

Vertical Angle	Horizontal Angles				
	0	22.5	45	67.5	90
0	229	229	229	229	229
5	232	225	227	223	221
10	236	233	226	223	219
15	247	239	229	221	220
20	260	248	237	225	221
25	271	257	241	230	226
30	279	264	244	234	227
35	283	267	244	231	223
40	273	260	241	221	212
45	253	240	225	202	194
50	218	210	190	174	168
55	170	166	146	140	134
60	122	120	105	104	100
65	76	76	68	68	67
70	33	38	38	37	34
75	13	13	16	14	14
80	7	7	7	8	8
85	2	2	2	3	3
90	0	0	0	0	0

Zonal Lumens		
Zone	Lumens	% Luminaire
0-10	22.3	2.6
10-20	70.5	8.3
20-30	125.3	14.8
30-40	177.5	21
40-50	197.1	23.3
50-60	155.2	18.4
60-70	77.3	9.1
70-80	17.2	2
80-90	2.9	0.3