



RBC4

4" BUILDERS PLUS LED NEW CONSTRUCTION
FIXED WALL WASH

PROJECT: _____

MODEL #: _____

LOCATION: _____

CONTACT: _____

4" BUILDERS PLUS LED NEW CONSTRUCTION FIXED WALL WASH

DIMENSIONS

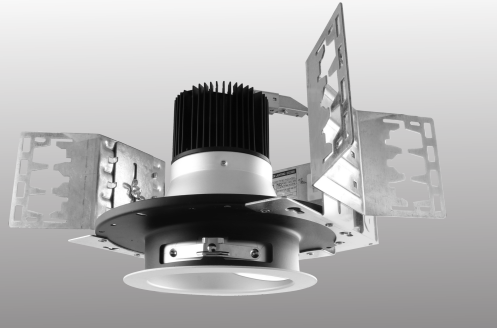
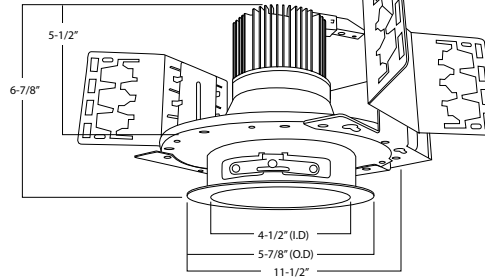

USE OF PRODUCT

The 4" Builders Plus LED Commercial Downlight series is the ideal product for energy efficient lighting in Non-IC New Construction commercial applications. Available in three color temperatures and lumen packages. Deep cone reflector designed for anti-glare purposes.

BUILDERS PLUS FEATURES

Lumen Selectable: 750 lm, 925 lm, 1090 lm
Color Temperature Selectable: 3000K, 3500K, 4000K
Locking mechanism optional
Optical Lens: 70° standard
Color Rendering Index: 84+ CRI
LED Life: 50,000 Hours
Driver Info: 120-277V; 50/60 Hz
Operating Temperature: -30°C - 40°C
Warranty: 5 year limited warranty

LED ENGINE

LED engine available in 3000K, 3500K, 4000K in 84+ CRI. Color temperature may be modified in field or preset with locking mechanism. LED Mounted to aluminum heat sink for maximum life output and thermal management.

FRAME CONSTRUCTION

Architectural frame includes butterfly brackets to accommodate C channel or flat bar hangers to tie down to ceiling grids. Junction box mounted to frame for easy wire access and for driver installation/replacement.

DIMMING

LED driver accommodates 120-277V input with 0-10V dimming protocol. Fixture available in 750 lm, 925 lm, 1090 lm. Lumens may be modified in field or preset with locking mechanism.

TRIM

Self-flanged spun aluminum reflector with frosted lens to shield direct view from LEDs. Reflector available in haze finish with white trim.

EMERGENCY BATTERY

Optional emergency battery available for a minimum of 90 minutes with both integral or remote test switch in 800 delivered lumens.

INSTALLATION

Non-IC housing. Insulation must be kept at least 3" away from fixture.

LABELS/COMPLIANCE

-cUL Listed
-Energy Star
-Title 24
-Wet location

ORDERING INFO

RBC4			UNV	W	H	W	FN	
Series	Lumens	Color Temperature	Voltage	Aperture type	Reflector	Trim	Frame	Frame Accessories
RBC4 - 4" Builder Plus Commercial Downlight	LS1 ¹ - Lumen Selectable (750, 925, 1090 lm) LL7 - Lumens Locked at 750 lm LL9 - Lumens Locked at 925 lm LL10 - Lumens Locked at 1090 lm	CTS - Color Temperature Selectable CT30 - Locked at 3000K CT35 - Locked at 3500K CT40 - Locked at 4000K	UNV - 120-277V	W - Wall Wash	H - Haze	W - White	FN - New Construction	C - C Channel bar hanger B - Flat bar hanger WJ - Wood Joist

Options

EIB - Emergency Battery with Integral Switch (800 Lumens)
ERB - Emergency Battery with Remote Switch (800 Lumens)

Notes

¹ Lumen selectable between 663 lm, 821 lm, 995 lm. Lumens may be modified in field.



www.rayonlighting.com
info@rayonlighting.com

tel: 323.446.2626
fax: 323.446.2606

Specification and product availability
subject to change without notice

04/21

PROJECT: _____

MODEL #: _____

LOCATION: _____

CONTACT: _____

DIMENSIONS

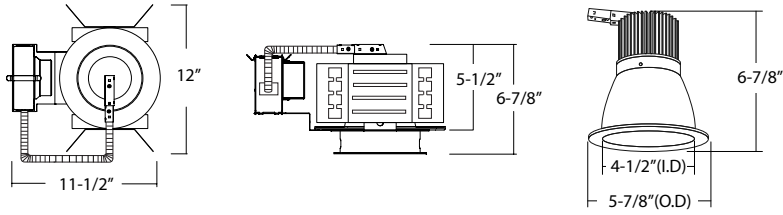

WATT/LUMENS CHART

Watt	Lumens	CRI
16W	750 lm	84+
21W	925 lm	84+
27W	1090 lm	84+

Performance based on 3500K

FRAME ACCESSORIES

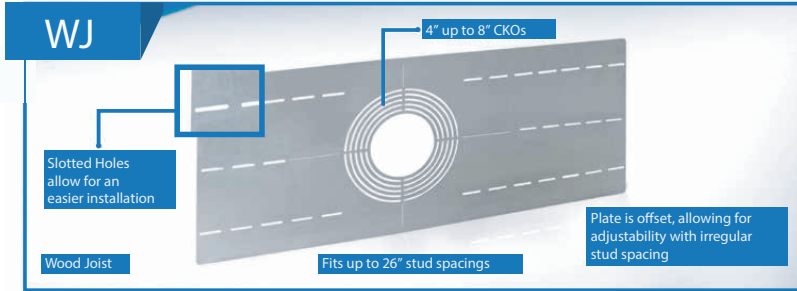

LIST OF COMPATIBLE DIMMERS

(120/277V 0-10 DIMMING)

MFR.	MODEL#	DIMMING RATE
Lutron	NFTV	1-100%
Lutron	NTSTV-DV	1-100%
Legrand	CD4FBLW	1-100%
Leviton	1P710-DL	1-100%

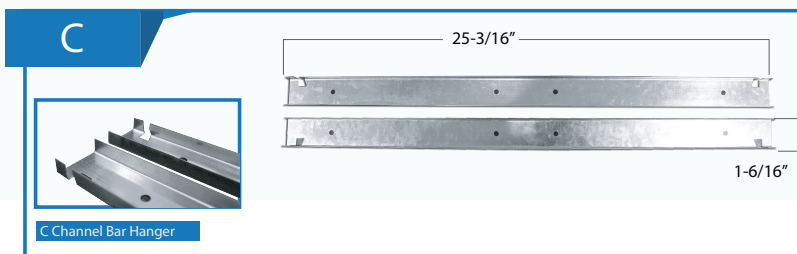
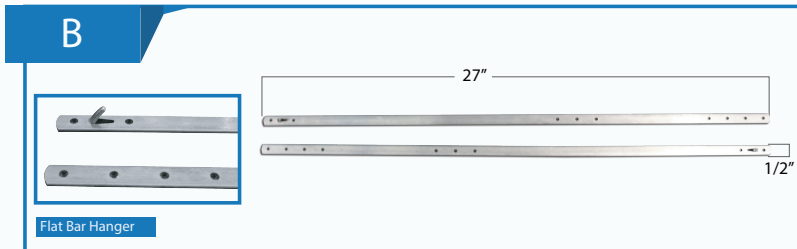

LUMEN AND COLOR TEMP. LOCK MECHANISM COVER



Lumen selectable locking mechanism cover

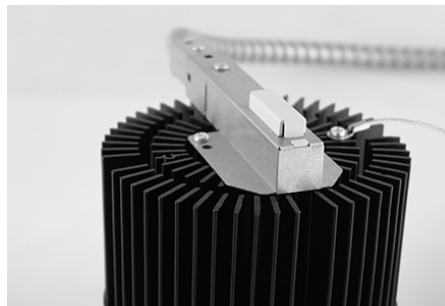

Color Temperature selectable locking mechanism cover