

PRIME

PRIME 4" LED ARCHITECTURAL SQUARE FLANGELESS DOWNLIGHT

JOB INFORMATION	TYPE:
	CATALOG NO.
	PROJECT NAME:
	COMMENTS:
	PREPARED BY:

USE OF PRODUCT

The 4" Prime Downlight Series is the ideal product for architectural energy efficient lighting in commercial and residential applications. Available in an assortment of color temperatures, optics, lumen outputs, and dimmable driver options.

PRIME FEATURES

Color Temperature: 2700K, 3000K, 3500K, or 4000K
 SDCM: 2 step binning
 Color Rendering Index: 93+ CRI
 Optical Lens: 18°, 30°, 50°, 80°
 Trim: Die cast or anodized
 LED Life: 50,000 Hours
 LED Type: Cree LED
 Driver Info: 120-277V, 50/60 Hz, PF>0.9, THD<0.20
 Warranty: 5 year limited warranty

LED ENGINE

LED engine available with CREE LEDs in 2700K, 3000K, 3500K, or 4000K in standard 93+ CRI. 2 Step MacAdam ellipse allows for color consistency between fixtures. LED mounted to aluminum heat sink for maximum life output and thermal management. Light engine provides a quick disconnect with locking strain relief to housing.

FRAME CONSTRUCTION

Constructed from 16 gauge heavy duty powder coated cold rolled steel frame with a large access junction box.

ADJUSTMENT

- Housing provides for 360° locking rotation
 - Aperture collar adjusts 15°± horizontally within frame for square ceiling alignment
 - Collar notch allows for easy alignment for square applications.
 - Aperture collar compatible up to 1½" ceiling thickness.
 - Accommodation for 2" or 3" ceiling thickness available upon request.

OPTICS

Field replaceable optical lens available in 18°, 30°, 50°, and 80°. Easily achieve narrow spot to wide flood beam pattern. Option for frosted, honeycomb, or solite filter (2 maximum).

DIMMING

Available in 8 driver selections. **(ID)** Standard all-inclusive ELV, Triac, and 0-10V dimming driver called Intelligent Drive, 120-277V. **(PEQ0)** Lutron Hi-Lume Premier Ecosystem 0.1% w/soft on, fade to black dimming, 120-277V. **(LDE1)** Lutron Hi-Lume 1% Ecosystem with soft on, fade to black dimming, 120-277V. **(LTE)** Lutron Hi-Lume 1% 2-wire, 120V. **(L3DA)** Hi-lume 1% EcoSystem/3-Wire L3D Driver **(EEI)** eldoLED Eco 1% Dim (0-10V), 120-277V. **(EDIO)** eldoLED Solo 0.1% Dim(0-10V), 120-277V. **(EDID)** eldoLED Solo 0.1% Dim(DALI), 120-277V.

THERMAL MANAGEMENT

Ambient temperatures at fixture location should not exceed -20° to 40°C.

EMERGENCY BATTERY

Optional emergency battery available for a minimum of 90 minutes with both integral or remote test switch in 800 or 1700 delivered lumens.

TRIM OPTIONS

- All trims are self flanged die cast or anodized.
 - Trim includes standard frosted acrylic diffuser.
 - 12% lumens increase if remove standard frosted acrylic diffuser in field.
 - Optical Enhancer reflects light evenly across the diffusion lens.
 - Trims available in round or square in an assortment of standard or made to order finishes.

LABELS/COMPLIANCE/WARRANTY

- CSA Listed for US and Canada
 - Energy Star
 - Dry/Damp/Wet location rated.
 - Title 24, JA8 Compliant
 - 5 Year limited warranty



HOUSING ORDERING INFORMATION

RPA4						
Series	Lumens	Color Temp	Voltage	Dimming	Optical Lens ⁹	Filter
PRIME SERIES	10L ¹ - 1035 lm	27 - 2700K	UNV - 120-277V	ID ³ - Standard all-inclusive ELV, Triac, and 0-10V dimming driver (Intelligent Drive) PEQ0 ⁵ - Lutron Hi-Lume Premier Ecosystem 0.1% w/soft on, fade to black dimming LDE1 ⁶ - Lutron Hi-Lume 1% Ecosystem with soft on, fade to black dimming LTE ⁷ - Lutron Hi-Lume 1% 2-wire L3DA - Hi-lume 1% EcoSystem/3-Wire L3D Driver EEI ^{6,7,8} - eldoLED Eco 1% Dim (0-10V) EDIO ^{6,7,8} - eldoLED Solo 0.1% Dim (0-10V) EDID ^{6,7,8} - eldoLED Solo 0.1% Dim (DALI)	18° - 18°	None - Leave blank
	12L ¹ - 1280 lm	30 - 3000K	120 - 120V		30 - 30°	F - Frosted filter
	16L ¹ - 1625 lm	35 - 3500K	347 ² - 347V		50 - 50°	H - Honey comb
	21L ¹ - 2115 lm	40 - 4000K			80 - 80°	S - Solite filter
	24L ¹ - 2480 lm					
	31L ¹ - 3100 lm					
	34L ¹ - 3430 lm					
	39L ¹ - 3965 lm					

Housing Type	Aperture	Frame Accessories	Collar	Option
NC - Non-IC New Construction IC - IC New Construction	SLDP - Square Flangeless Downlight Plaster SLDM - Square Flangeless Downlight Millwork	C - C Channel bar hanger B - Flat bar hanger	Blank - 1.5" Depth 20 - 2" Depth 30 - 3" Depth MTO - Made to order	EI8 - Emergency battery with integral switch(800 Lumens) ER8 - Emergency battery with remote switch (800 Lumens) EI17 - Emergency battery with integral switch(1700 Lumens) ER17 - Emergency battery with remote switch (1700 Lumens) FCJS-E - Vive wireless individual controller(Ecosystem) FCJS-O - Vive wireless individual controller(0-10) CP ¹⁰ - Chicago Plenum

TRIM ORDERING INFORMATION

4SLO		
Aperture Size / Shape / Trim Type / Style	Bevel Finish	Options
4SLO - 4" Square Flangeless Open	W - White B - Black H - Haze S - Specular Clear WE - Wheat MTO - Made to order	WL - Wet location

- Compatible with IC new construction housing.
- Step down transformer required.
- Intelligent Drive is the standard driver.
- Driver must not exceed 1625 lm
- 120V only.
- Inapplicable to 3965 Lumen offering.
- Must specify logarithmic or linear eldoLED driver.
- Confirm dimming curve: linear or logarithmic.
- Without standard frosted acrylic diffuser.
- Compatible up to 2115 lumens.

PRIME

PRIME 4" LED ARCHITECTURAL
SQUARE FLANGELESS DOWNLIGHT

JOB INFORMATION	TYPE:
	CATALOG NO.:
	PROJECT NAME:
	COMMENTS:
	PREPARED BY:

4" PRIME DOWNLIGHT

LUMEN CHART

Wattage	Delivered Lumens	Voltage	CRI
11W	1035Lm	120-277V	93+
16W	1280 Lm	120-277V	93+
20W	1625 Lm	120-277V	93+
30W	2115 Lm	120-277V	93+
31W	2480 Lm	120-277V	93+
38W	3100 Lm	120-277V	93+
45W	3430 Lm	120-277V	93+
58W	3965 Lm	120-277V	93+

*Above chart, ordering information, and IES File name reflect delivered lumens based 3000K and 30° optical lens.
**Lumens will vary based on CCT, optical lens, and bevel finish.

DIMENSION

Trim Details

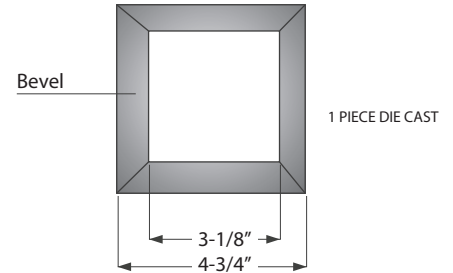
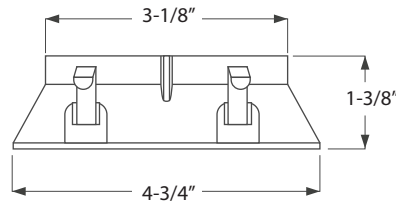
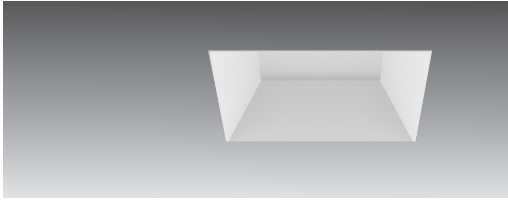

LED HOLDER & FILTER DIMENSION

LED Holder and Filter

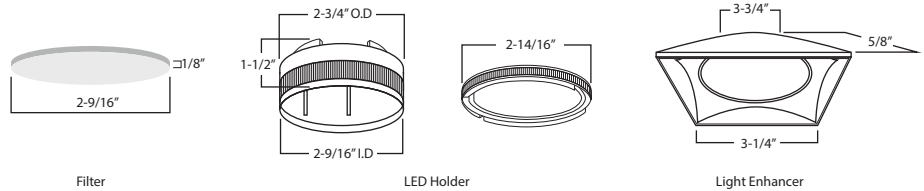
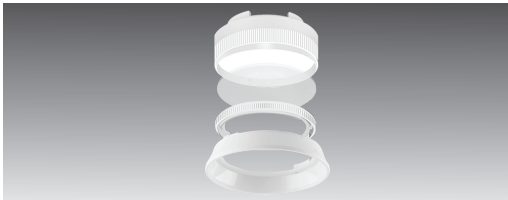

PRIME

PRIME 4" LED ARCHITECTURAL
SQUARE FLANGELESS DOWNLIGHT

JOB INFORMATION	TYPE:
	CATALOG NO.:
	PROJECT NAME:
	COMMENTS:
	PREPARED BY:

4" PRIME DOWNLIGHT

HOUSING DIMENSION

IC Housing Details

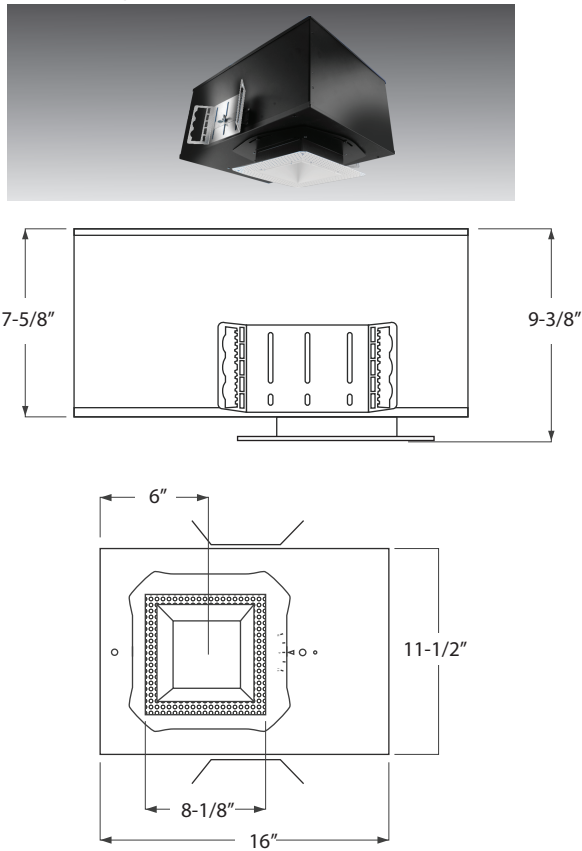

Non-IC Housing Details

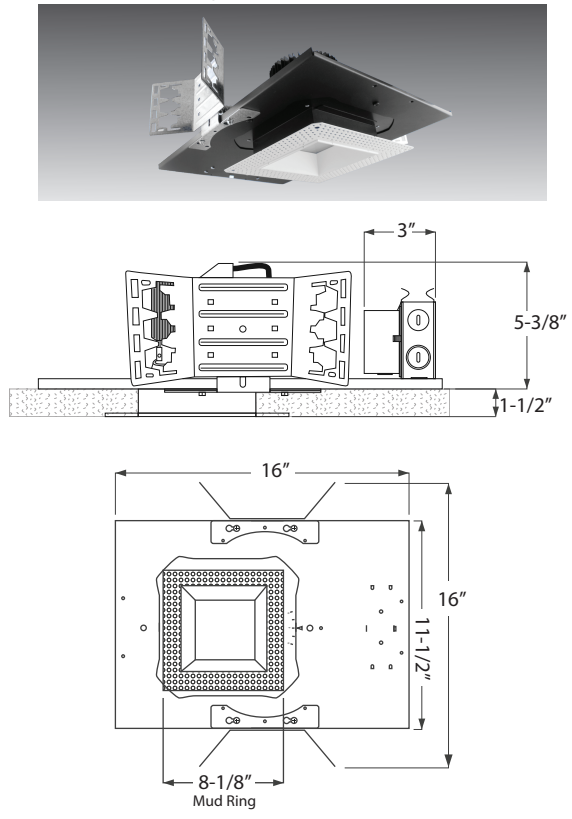

Ceiling Cut-out: 5-3/16 X 5-3/16"
Maximum Ceiling Thickness: 1-1/2"
Minimum Ceiling Thickness: 1/2"
Consult factory for custom ceiling thickness

COLLAR DEPTH PER CEILING THICKNESS

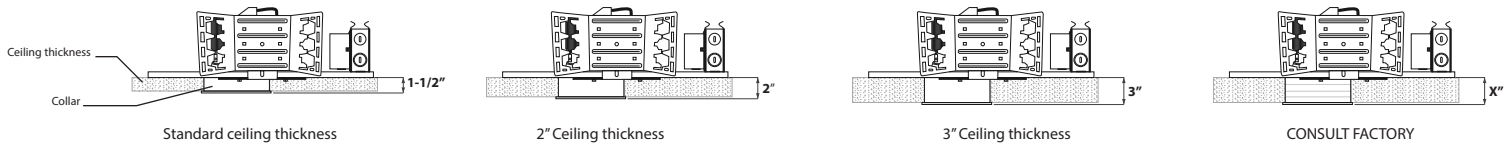

PRIME

PRIME 4" LED ARCHITECTURAL
SQUARE FLANGELESS DOWNLIGHT

4" PRIME DOWNLIGHT

IES TECH INFO AT A GLANCE

RPA - 10L 18° BEAM

TEST DATE	2020-3-23
SERIES	RPA4-10L-30K-18°-SFD
LUMENS	975.7 LM
WATTS	11.87 W
CCT	3000K

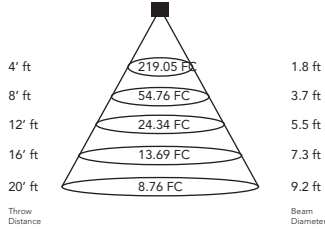

Zone	Lumens	%Lamp	%Luminaire
0-30	812.2	83.2%	83.2%
0-40	891.6	91.4%	91.3%
0-60	960.0	98.4%	98.3%
60-90	16.2	1.7%	1.7%
0-90	976.3	100.1%	100%

RPA - 10L 30° BEAM

TEST DATE	2020-3-23
SERIES	RPA4-10L-30K-30°-SFD
LUMENS	1034.8 LM
WATTS	11.88 W
CCT	3000K

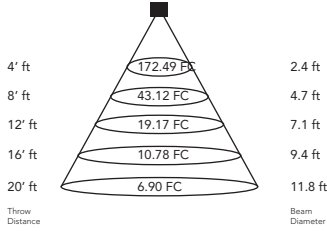

Zone	Lumens	%Lamp	%Luminaire
0-30	895.0	86.5%	86.5%
0-40	982.7	95.0%	95%
0-60	1,024.4	99.0%	99.0%
60-90	10.3	1%	1%
0-90	1,034.7	100%	100%

RPA - 10L 60° BEAM

TEST DATE	2020-3-23
SERIES	RPA4-10L-30K-60°-SFD
LUMENS	972.8 LM
WATTS	11.88 W
CCT	3000K

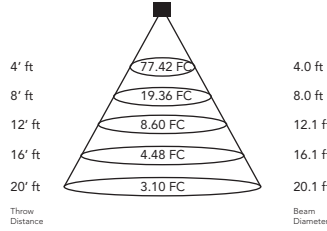

Zone	Lumens	%Lamp	%Luminaire
0-30	734.0	75.5%	75.5%
0-40	888.0	91.3%	91.3%
0-60	955.0	98.2%	98.2%
60-90	17.2	1.8%	1.8%
0-90	972.2	99.9%	100%

RPA - 10L 80° BEAM

TEST DATE	2020-3-23
SERIES	RPA4-10L-30K-80°-SFD
LUMENS	912 LM
WATTS	11.89 W
CCT	3000K

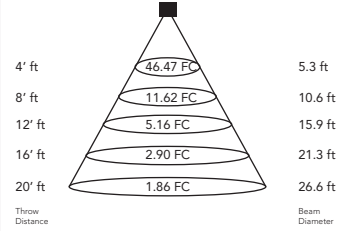

Zone	Lumens	%Lamp	%Luminaire
0-30	543.6	59.6%	59.6%
0-40	757.0	83.0%	83.1%
0-60	878.8	96.4%	96.4%
60-90	32.5	3.6%	3.6%
0-90	911.3	99.9%	100%

RPA - 12L 30° BEAM

TEST DATE	2020-3-23
SERIES	RPA4-12L-30K-30°-SFD
LUMENS	1278.9 LM
WATTS	16.02 W
CCT	3000K

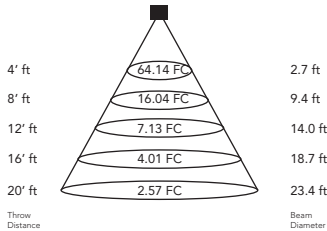

Zone	Lumens	%Lamp	%Luminaire
0-30	617.0	48.2%	48.3%
0-40	882.6	96%	69%
0-60	1,206.9	94.4%	94.4%
60-90	71.6	5.6%	5.6%
0-90	1,278.5	100%	100%

RPA - 12L 60° BEAM

TEST DATE	2020-3-23
SERIES	RPA4-12L-30K-60°-SFD
LUMENS	1136.2 LM
WATTS	16.02 W
CCT	3000K

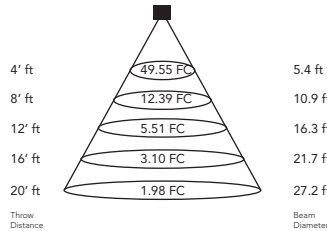

Zone	Lumens	%Lamp	%Luminaire
0-30	512.9	45.1%	45.2%
0-40	755.1	66.5%	66.5%
0-60	1,063.3	93.6%	93.6%
60-90	72.4	6.4%	6.4%
0-90	1,135.7	100%	100%

RPA - 12L 80° BEAM

TEST DATE	2020-3-23
SERIES	RPA4-12L-30K-80°-SFD
LUMENS	1064.7 LM
WATTS	16.02 W
CCT	3000K

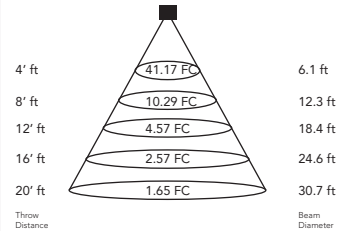

Zone	Lumens	%Lamp	%Luminaire
0-30	453.5	42.6%	42.6%
0-40	684.7	64.3%	64.3%
0-60	986.1	92.6%	92.7%
60-90	78.2	7.3%	7.3%
0-90	1,064.3	100%	100%

[CLICK HERE OR VISIT PRODUCT PAGE FOR COMPREHENSIVE TECHNICAL INFORMATION](#)

PRIME

PRIME 4" LED ARCHITECTURAL
SQUARE FLANGELESS DOWNLIGHT

4" PRIME DOWNLIGHT

IES TECH INFO AT A GLANCE

RPA - 16L 18° BEAM

TEST DATE	2020-3-23
SERIES	RPA4-16L-30K-18°-SFD
LUMENS	1536.1 LM
WATTS	20.74 W
CCT	3000K

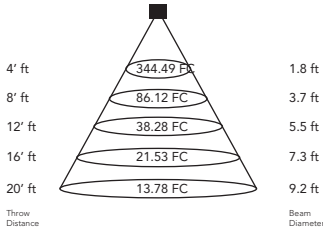

Zone	Lumens	%Lamp	%Luminaire
0-30	1,277.3	83.2%	83.1%
0-40	1,402.4	91.3%	91.3%
0-60	1,510.6	98.3%	98.3%
60-90	26.3	1.7%	1.7%
0-90	1,536.8	100%	100%

RPA - 16L 30° BEAM

TEST DATE	2020-3-23
SERIES	RPA4-16L-30K-30°-SFD
LUMENS	1625.7 LM
WATTS	20.76 W
CCT	3000K

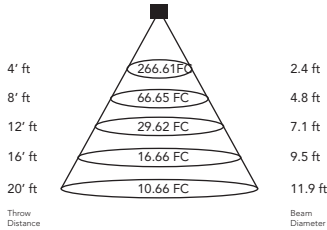

Zone	Lumens	%Lamp	%Luminaire
0-30	1,401.5	86.2%	86.2%
0-40	1,542.0	94.9%	94.8%
0-60	1,608.9	99%	99%
60-90	17.0	1%	1%
0-90	1,625.9	100%	100%

RPA - 16L 60° BEAM

TEST DATE	2020-3-23
SERIES	RPA4-16L-30K-60°-SFD
LUMENS	1531.9 LM
WATTS	20.76 W
CCT	3000K

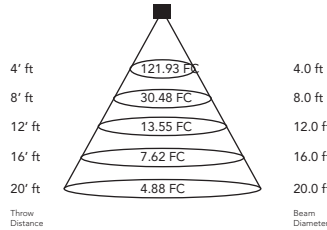

Zone	Lumens	%Lamp	%Luminaire
0-30	1,155.4	75.4%	75.5%
0-40	1,397.4	91.2%	91.3%
0-60	1,503.1	98.1%	98.2%
60-90	27.7	1.8%	1.8%
0-90	1,530.8	99.9%	100%

RPA - 16L 80° BEAM

TEST DATE	2020-3-23
SERIES	RPA4-16L-30K-80°-SFD
LUMENS	1439.1 LM
WATTS	20.76 W
CCT	3000K

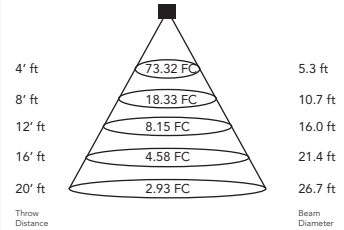

Zone	Lumens	%Lamp	%Luminaire
0-30	855.7	59.5%	59.5%
0-40	1,194.0	83%	83%
0-60	1,386.4	96.3%	96.4%
60-90	51.8	3.6%	3.6%
0-90	1,438.2	99.9%	100%

RPA - 21L 18° BEAM

TEST DATE	2020-3-23
SERIES	RPA4-21L-30K-18°-SFD
LUMENS	2011.9 LM
WATTS	29.76 W
CCT	3000K

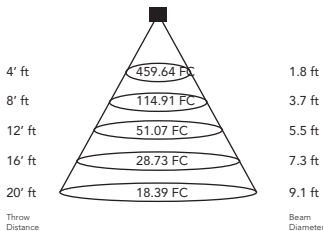

Zone	Lumens	%Lamp	%Luminaire
0-30	1,674.6	83.2%	83.1%
0-40	1,838.8	91.4%	91.3%
0-60	1,980.1	98.4%	98.3%
60-90	34.6	1.7%	1.7%
0-90	2,014.8	100.1%	100%

RPA - 21L 30° BEAM

TEST DATE	2020-3-23
SERIES	RPA4-21L-30K-30°-SFD
LUMENS	2116.6 LM
WATTS	29.71 W
CCT	3000K

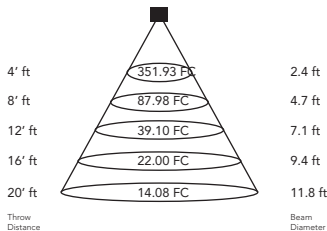

Zone	Lumens	%Lamp	%Luminaire
0-30	1,828.2	86.4%	86.4%
0-40	2,008.1	94.9%	94.9%
0-60	2,093.9	98.9%	98.9%
60-90	22.2	1.1%	1.1%
0-90	2,116.2	100%	100%

RPA - 21L 60° BEAM

TEST DATE	2020-3-23
SERIES	RPA4-21L-30K-60°-SFD
LUMENS	1992.4 LM
WATTS	29.73 W
CCT	3000K

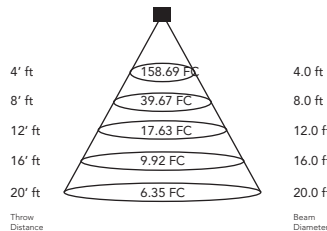

Zone	Lumens	%Lamp	%Luminaire
0-30	1,504.0	75.5%	75.6%
0-40	1,818.3	91.3%	91.3%
0-60	1,954.6	98.1%	98.2%
60-90	36.1	1.8%	1.8%
0-90	1,990.7	99.9%	100%

RPA - 21L 80° BEAM

TEST DATE	2020-3-23
SERIES	RPA4-21L-30K-80°-SFD
LUMENS	1867.2 LM
WATTS	29.73 W
CCT	3000K

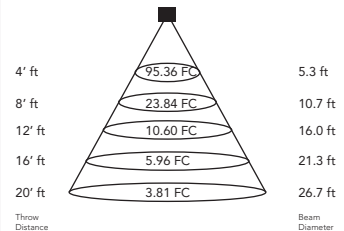

Zone	Lumens	%Lamp	%Luminaire
0-30	1,110.7	59.5%	59.5%
0-40	1,549.4	83%	83%
0-60	1,798.7	96.3%	96.4%
60-90	67.4	3.6%	3.6%
0-90	1,866.1	99.9%	100%

[CLICK HERE OR VISIT PRODUCT PAGE FOR COMPREHENSIVE TECHNICAL INFORMATION](#)

PRIME

PRIME 4" LED ARCHITECTURAL
SQUARE FLANGELESS DOWNLIGHT

4" PRIME DOWNLIGHT

IES TECH INFO AT A GLANCE

RPA - 24L 18° BEAM

TEST DATE 2020-3-23
SERIES RPA4-24L-30K-18°-SFD
LUMENS 2372.4 LM
WATTS 28.51 W
CCT 3000K

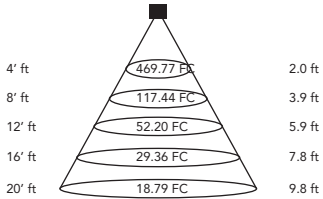

Throw Distance Beam Diameter

Zone	Lumens	%Lamp	%Luminaire
0-30	1,941.2	81.8%	81.8%
0-40	2,159.8	91%	91%
0-60	2,332.3	98.3%	98.2%
60-90	41.9	1.8%	1.8%
0-90	2,374.2	100.1%	100%

Zone Lumen Summary

RPA - 24L 30° BEAM

TEST DATE 2020-3-23
SERIES RPA4-24L-30K-30°-SFD
LUMENS 2480.4 LM
WATTS 28.31 W
CCT 3000K

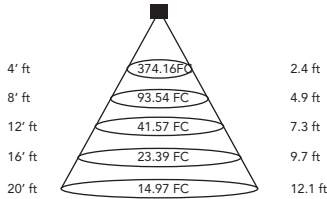

Throw Distance Beam Diameter

Zone	Lumens	%Lamp	%Luminaire
0-30	2,068.9	83.4%	83.4%
0-40	2,332.5	94%	94.1%
0-60	2,450.5	98.8%	98.8%
60-90	29.5	1.2%	1.2%
0-90	2,479.9	100%	100%

Zone Lumen Summary

RPA - 24L 60° BEAM

TEST DATE 2020-3-23
SERIES RPA4-24L-30K-60°-SFD
LUMENS 2343.3 LM
WATTS 28.31 W
CCT 3000K

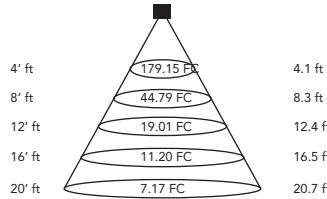

Throw Distance Beam Diameter

Zone	Lumens	%Lamp	%Luminaire
0-30	1,723.5	73.6%	73.6%
0-40	2,121.1	90.5%	90.6%
0-60	2,295.8	98%	98.1%
60-90	45.2	1.9%	1.9%
0-90	2,341.0	99.9%	100%

Zone Lumen Summary

RPA - 24L 80° BEAM

TEST DATE 2020-3-23
SERIES RPA4-24L-30K-80°-SFD
LUMENS 2209.4 LM
WATTS 28.34 W
CCT 3000K

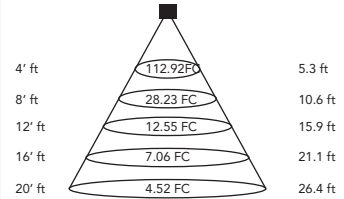

Throw Distance Beam Diameter

Zone	Lumens	%Lamp	%Luminaire
0-30	1,316.6	59.6%	59.6%
0-40	1,832.6	82.9%	83%
0-60	2,128.8	96.4%	96.4%
60-90	79.7	3.6%	3.6%
0-90	2,208.6	100%	100%

Zone Lumen Summary

RPA - 31L 18° BEAM

TEST DATE 2020-3-23
SERIES RPA4-31L-30K-18°-SFD
LUMENS 2934.3 LM
WATTS 37.74 W
CCT 3000K

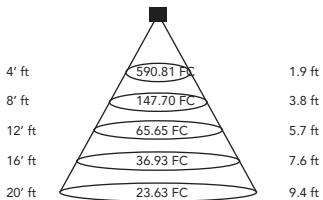

Throw Distance Beam Diameter

Zone	Lumens	%Lamp	%Luminaire
0-30	2,395.5	81.6%	81.6%
0-40	2,668.0	90.9%	90.9%
0-60	2,883.4	98.3%	98.2%
60-90	52.3	1.8%	1.8%
0-90	2,935.8	100.1%	100%

Zone Lumen Summary

RPA - 31L 30° BEAM

TEST DATE 2020-3-23
SERIES RPA4-31L-30K-30°-SFD
LUMENS 3098.9 LM
WATTS 37.75 W
CCT 3000K

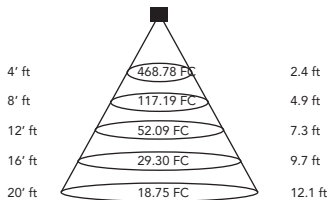

Throw Distance Beam Diameter

Zone	Lumens	%Lamp	%Luminaire
0-30	2,586.0	83.4%	83.4%
0-40	2,916.1	94.1%	94.1%
0-60	3,062.3	98.8%	98.9%
60-90	37.0	1.2%	1.2%
0-90	3,099.3	100%	100%

Zone Lumen Summary

RPA - 31L 60° BEAM

TEST DATE 2020-3-23
SERIES RPA4-31L-30K-60°-SFD
LUMENS 2897.2 LM
WATTS 37.91 W
CCT 3000K

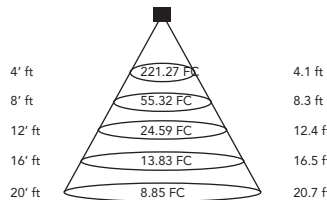

Throw Distance Beam Diameter

Zone	Lumens	%Lamp	%Luminaire
0-30	2,127.9	73.4%	73.5%
0-40	2,621.1	90.5%	90.5%
0-60	2,838.8	98%	98.1%
60-90	56.3	1.9%	1.9%
0-90	2,895.1	99.9%	100%

Zone Lumen Summary

RPA - 31L 80° BEAM

TEST DATE 2020-3-23
SERIES RPA4-31L-30K-80°-SFD
LUMENS 2759.4 LM
WATTS 37.90 W
CCT 3000K

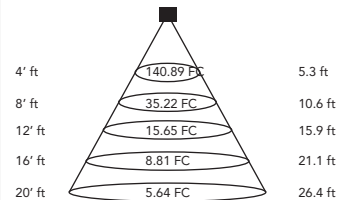

Throw Distance Beam Diameter

Zone	Lumens	%Lamp	%Luminaire
0-30	1,644.4	59.6%	59.6%
0-40	2,289.0	83%	83%
0-60	2,658.4	96.3%	96.4%
60-90	99.8	3.6%	3.6%
0-90	2,758.2	100%	100%

Zone Lumen Summary

[CLICK HERE OR VISIT PRODUCT PAGE FOR COMPREHENSIVE TECHNICAL INFORMATION](#)

PRIME

PRIME 4" LED ARCHITECTURAL SQUARE FLANGELESS DOWNLIGHT

IES TECH INFO AT A GLANCE

RPA - 34L 18° BEAM

TEST DATE	2020-3-23
SERIES	RPA4-34L-30K-18°-SFD
LUMENS	3305.2 LM
WATTS	44.52 W
CCT	3000K

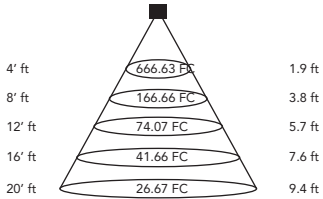

Throw Distance Beam Diameter

Zone	Lumens	%Lamp	%Luminaire
0-30	2,700.5	81.7%	81.7%
0-40	3,006.2	91%	90.9%
0-60	3,247.9	98.3%	98.2%
60-90	58.9	1.8%	1.8%
0-90	3,306.7	100%	100%

Zone Lumen Summary

RPA - 34L 30° BEAM

TEST DATE	2020-3-23
SERIES	RPA4-34L-30K-30°-SFD
LUMENS	3432.7 LM
WATTS	44.60 W
CCT	3000K

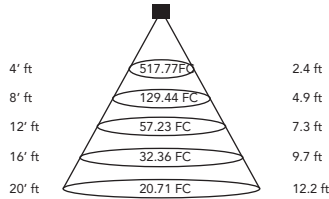

Throw Distance Beam Diameter

Zone	Lumens	%Lamp	%Luminaire
0-30	2,861.0	83.3%	83.4%
0-40	3,226.3	94%	94%
0-60	3,390.8	98.8%	98.8%
60-90	41.5	1.2%	1.2%
0-90	3,432.3	100%	100%

Zone Lumen Summary

RPA - 34L 60° BEAM

TEST DATE	2020-3-23
SERIES	RPA4-34L-30K-60°-SFD
LUMENS	3246.8 LM
WATTS	44.61 W
CCT	3000K

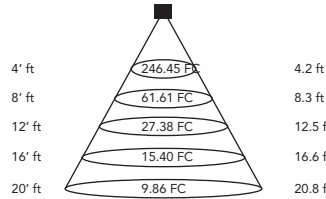

Throw Distance Beam Diameter

Zone	Lumens	%Lamp	%Luminaire
0-30	2,385.3	73.5%	73.5%
0-40	2,938.6	90.5%	90.6%
0-60	3,181.1	98%	98.1%
60-90	63.2	1.9%	1.9%
0-90	3,244.3	99.9%	100%

Zone Lumen Summary

RPA - 34L 80° BEAM

TEST DATE	2020-3-23
SERIES	RPA4-34L-30K-80°-SFD
LUMENS	3054.3 LM
WATTS	44.70 W
CCT	3000K

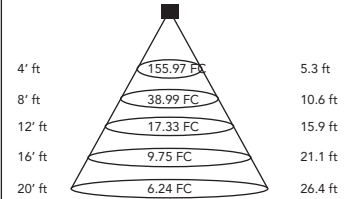

Throw Distance Beam Diameter

Zone	Lumens	%Lamp	%Luminaire
0-30	1,819.9	59.6%	59.6%
0-40	2,533.1	82.9%	83%
0-60	2,942.2	96.3%	96.4%
60-90	110.6	3.6%	3.6%
0-90	3,052.8	100%	100%

Zone Lumen Summary

RPA - 39L 18° BEAM

TEST DATE	2020-3-23
SERIES	RPA4-31L-30K-18°-SFD
LUMENS	3832.8 LM
WATTS	57.44 W
CCT	3000K

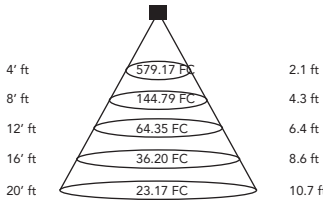

Throw Distance Beam Diameter

Zone	Lumens	%Lamp	%Luminaire
0-30	2,871.0	74.9%	74.9%
0-40	3,353.9	87.5%	87.5%
0-60	6,694.0	96.4%	96.4%
60-90	139.4	3.6%	3.6%
0-90	3,833.4	100%	100%

Zone Lumen Summary

RPA - 39L 30° BEAM

TEST DATE	2020-3-23
SERIES	RPA4-39L-30K-30°-SFD
LUMENS	3965.7 LM
WATTS	57.62 W
CCT	3000K

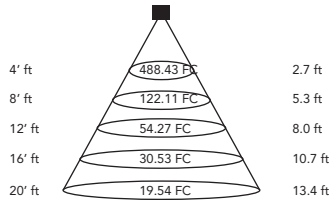

Throw Distance Beam Diameter

Zone	Lumens	%Lamp	%Luminaire
0-30	3,049.1	76.9%	76.9%
0-40	3,618.5	91.2%	91.3%
0-60	3,895.6	92.2%	98.3%
60-90	69.3	1.7%	1.7%
0-90	3,964.8	100%	100%

Zone Lumen Summary

RPA - 39L 60° BEAM

TEST DATE	2020-3-23
SERIES	RPA4-39L-30K-60°-SFD
LUMENS	3771.7 LM
WATTS	57.68 W
CCT	3000K

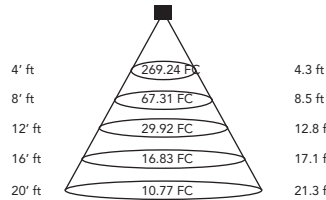

Throw Distance Beam Diameter

Zone	Lumens	%Lamp	%Luminaire
0-30	2,621.5	69.5%	69.6%
0-40	3,331.8	88.3%	88.4%
0-60	3,680.2	97.6%	97.6%
60-90	88.6	2.4%	2.4%
0-90	3,768.9	99.9%	100%

Zone Lumen Summary

RPA - 39L 80° BEAM

TEST DATE	2020-3-23
SERIES	RPA4-39L-30K-80°-SFD
LUMENS	3661.4 LM
WATTS	57.76 W
CCT	3000K

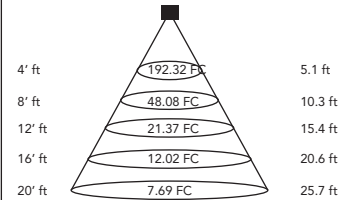

Throw Distance Beam Diameter

Zone	Lumens	%Lamp	%Luminaire
0-30	2,200.4	60.1%	60.1%
0-40	3,035.5	82.6%	83%
0-60	3,525.6	96.3%	96.4%
60-90	133.5	3.6%	3.6%
0-90	3,659.1	100%	100%

Zone Lumen Summary

[CLICK HERE OR VISIT PRODUCT PAGE FOR COMPREHENSIVE TECHNICAL INFORMATION](#)