

**DRILLED MOUNT OPTIONS**

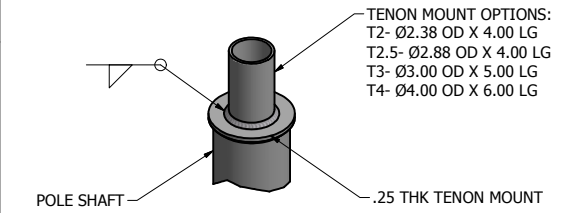

**TENON MOUNT OPTIONS**

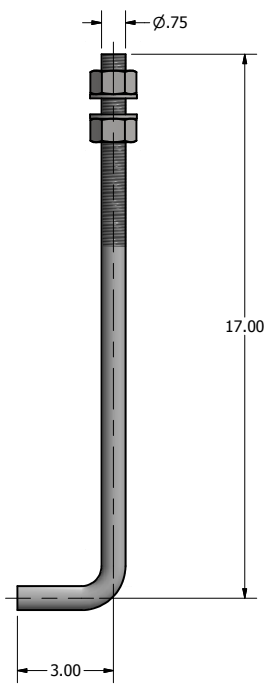

**Ø.75 X 20.00 ANCHOR BOLT**

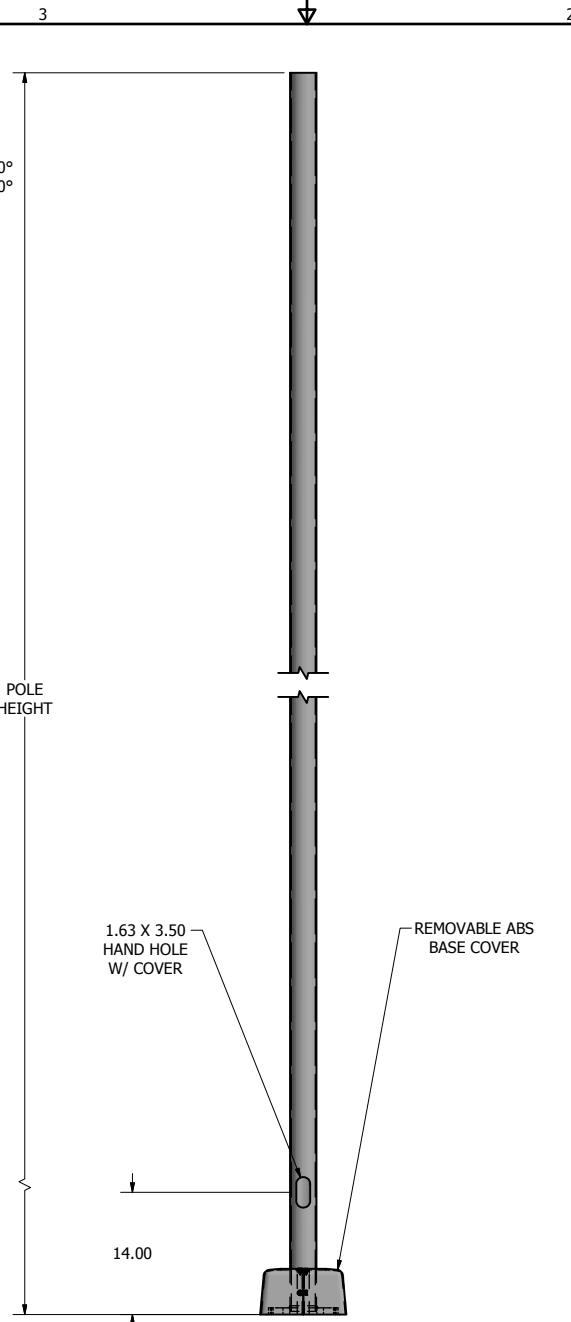

**POLE DETAIL**

POLE SPECIFICATIONS			
NO.	COMPONENT	ASTM DESIGNATION	MIN. YIELD (P.S.I)
1.	POLE SHAFT	A-500 GR. B	46,000
2.	BASE PLATE	A36	36,000
3.	ANCHOR BOLTS	F1554 GR. 55	55,000
4.	GALVANIZED HARDWARE	A153	-

FINISH SPECIFICATIONS			
POLES SHALL HAVE A POLYESTER POWDER COAT FINISH IN A STANDARD COLOR.			
POLE DIMENSIONS			
POLE HGT. (FT.)	TOP DIA. (IN.)	BOTTOM DIA. (IN.)	MTG. HGT. (FT.)
12'	3.00	3.00	12'

BASE PLATE DIMENSIONS			
BOLT CIRCLE (IN.)	BASE PLATE DIM. (IN.)	BOLT HOLE (IN.)	PLATE THK. (IN.)
8.00-9.00	8.00 SQ	1.00	.75

  

ANCHOR BOLT DIMENSIONS	
ANCHOR BOLT DIA. (IN.)	ANCHOR BOLT LENGTH (IN.)
.75	20.00

  

ALLOWABLE WIND LOADING (SQ. FT.)					
WIND*	INDICATED EPA	80 MPH	90 MPH	100 MPH	120 MPH
EPA	-	6.9	5.0	3.9	2.1

\*WITH 1.3 GUST FACTOR

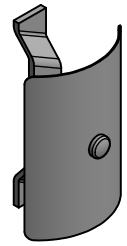

**1.63 X 3.50 HAND HOLE COVER**

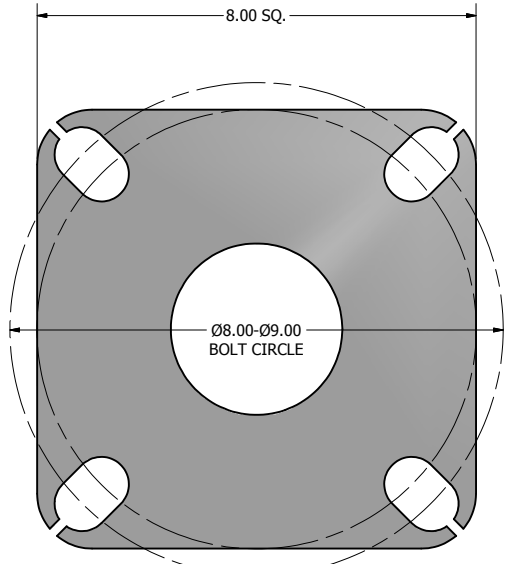

**8.00 X 8.00 X .75 THK. BASE PLATE**

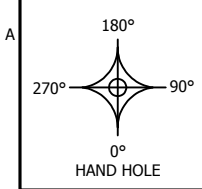

DRAWN: M. HARVALA	6/8/2015
CHECKED	
REVISION:	DATE:
APPROVED:	
QUOTE:	
S.O.#	
REF:	SCALE: NONE

**UNITED LIGHTING STANDARDS**  
A DWH COMPANY

23171 Groesbeck Hwy.  
 Warren, MI 48089  
 P: (586) 774-5650 | F: (586) 774-5706  
[www.unitedlightingstandards.com](http://www.unitedlightingstandards.com)

SOME GEOGRAPHICAL AREAS HAVE SPECIAL WIND CONDITIONS THAT CAN CREATE WIND INDUCED VIBRATIONS CAUSING A FATIGUE PROBLEM. NO METHOD HAS YET BEEN FOUND FOR PREDICTING DESTRUCTIVE LIGHTING POLE VIBRATION. THESE CONDITIONS ARE UNIQUE AND CANNOT BE GUARANTEED AGAINST, AND ARE THE RESPONSIBILITY OF A LOCAL SITE ENGINEER.		
TITLE:		
CATALOG:		
DWG NO: RSP-12-3-11	SIZE: C	SHEET 1 OF 1

# POLE ORDERING GUIDE

## ORDER NUMBER TEMPLATE

### Example Order Number

Fixture			Catalog Number				Mounting Type	Fixture Mounting Arrangement	Finish	Options			Accessories		
Brand	Product	Number	Design	Mounting Height	Shaft Size	Wall Thickness				Design	Orientation	Height From Base	Design	Orientation	Height From Base
			RPSQ	20	4	11	AB	T2	DB	WB-15	@90	10'	FH	@180	9'

### Build Your Order Number

Fixture			Catalog Number				Mounting Type	Fixture Mounting Arrangement	Finish	Options			Accessories		
Brand	Product	Number	Design	Mounting Height	Shaft Size	Wall Thickness				Design	Orientation	Height From Base	Design	Orientation	Height From Base

### Mounting Type

AB = Anchor Base  
EMB = Embedded (Direct Burial)

### Fixture Mounting Arrangement

D1      D4  
D2@90    T2  
D2@180   T2.5  
D3@90    T3  
D3@120\*   T4

\*Round poles only

Refer to the Mounting Orientation Guide on the next page of this file.

### Finish

WH = White  
TWH = Textured White  
DB = Dark Bronze  
TMB = Textured Medium Bronze  
HB = Harvest Bronze  
NB = New Bronze  
SL = Silver  
MGY = Medium Gray  
GR = Gray  
TGR = Textured Gray  
GM = Graphite Metallic  
DP = Dark Platinum  
MA = Matte Aluminum  
PSP = Platinum Silver  
BK = Black  
TBK = Textured Black  
MG = Moss Green

Contact us for custom colors.

### Options

CMB = Camera Mounting Bracket  
CMP = Camera Mounting Plate  
WB-15 = Welded Bracket  
WC = Welded Coupling (denote size)  
WN = Welded Nipple (denote size)  
Festoon = Festoon Provision  
CSBC = Custom Steel Base Cover  
VD = Vibration Dampener  
GFCI/IUC = Ground Fault Circuit Interrupter with In-Use Cover  
UL = UL Listed\*\*

\*See our online product catalog for complete catalog numbers of these options and accessories.

\*\* UL Listed labeling is available for catalog steel and aluminum poles—both Commercial & Industrial and Roadway. UL Listed labeling is not available for brackets. UL Listing must be specified at the time of order.

Note: N/A = Not Applicable

### Accessories

TB = Transformer Base\*  
ABS-BC = ABS Base Cover\*  
LW = Lowering Winch  
LW-ELECTRIC = Electric Lowering Winch  
BA = Banner Arm  
FH = Flag Holder  
PTTA = Pole Top Tenon Adapter\*