

REMOVABLE CAP

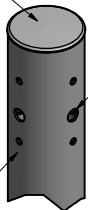

DRILLED PER FIXTURE REQUIREMENTS:
 D1- DRILLED FOR 1 FIXTURE
 D2- DRILLED FOR 2 FIXTURES AT 90° OR 180°
 D3- DRILLED FOR 3 FIXTURES AT 90° OR 120°
 D4- DRILLED FOR 4 FIXTURES

POLE SHAFT
DRILLED MOUNT OPTIONS

TENON MOUNT OPTIONS:
 T2- Ø2.38 OD X 4.00 LG
 T3- Ø3.00 OD X 5.00 LG
 T4- Ø4.00 OD X 6.00 LG

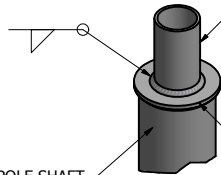

POLE SHAFT
 .25 THK. TENON MOUNT
TENON MOUNT OPTIONS

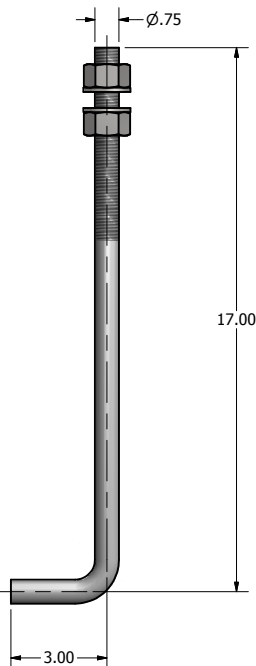

Ø.75 X 20.00 ANCHOR BOLT

POLE HEIGHT
 (FT.)

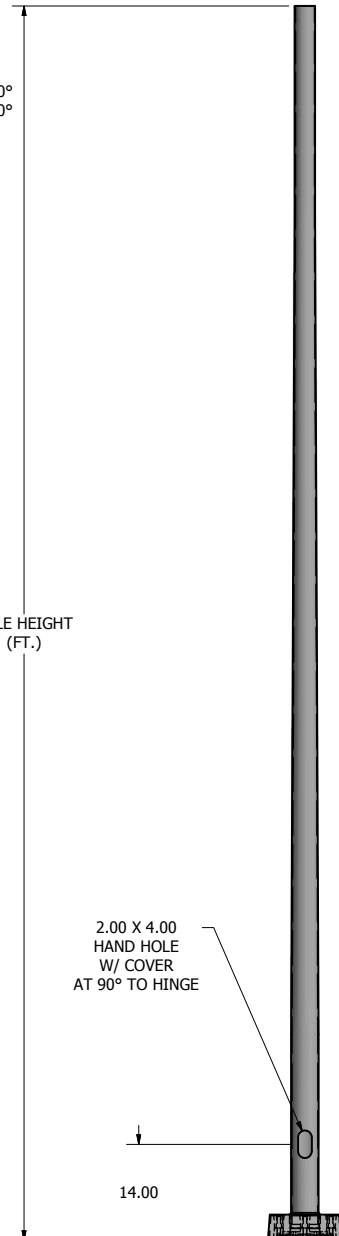

POLE DETAIL

POLE SPECIFICATIONS					
NO.	COMPONENT	ASTM DESIGNATION			
1.	POLE SHAFT	A-500 GR. B			
2.	BASE PLATE	A36			
3.	ANCHOR BOLTS	F1554 GR. 55			
4.	GALVANIZED HARDWARE	A153			
FINISH SPECIFICATIONS					
POLES SHALL HAVE A POLYESTER POWDER COAT FINISH IN A STANDARD COLOR.					
POLE DIMENSIONS					
POLE HGT. (FT.)	TOP DIA. (IN.)	BOTTOM DIA. (IN.)	GAGE	MTG. HGT. (FT.)	
10'	3.00	4.00	.125	10'	
BASE PLATE DIMENSIONS					
BOLT CIRCLE (IN.)	BASE PLATE DIM. (IN.)	BOLT HOLE (IN.)	PLATE THK. (IN.)		
7.50-9.00	10.75 SQ	.81	.75		
ANCHOR BOLT DIMENSIONS					
ANCHOR BOLT DIA. (IN.)			ANCHOR BOLT LENGTH (IN.)		
.75			20.00		
ALLOWABLE WIND LOADING (SQ. FT.)					
WIND*	INDICATED EPA	80 MPH	90 MPH	100 MPH	120 MPH
EPA	-	10.0	7.4	5.7	3.4

*WITH 1.3 GUST FACTOR

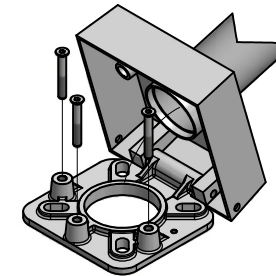

BASE ROTATION DETAIL VIEW

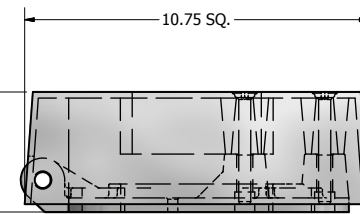
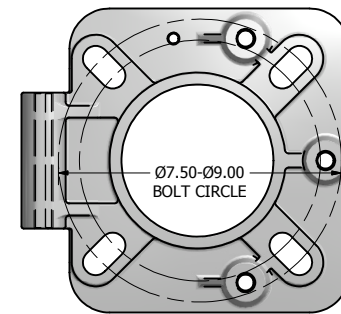

10.75 X 10.75 X 3.50 THK. BASE CASTING

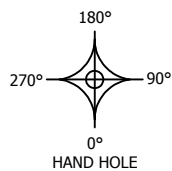

DRAWN: M. HARVALA	2/4/2015
CHECKED	
REVISION:	DATE:
APPROVED:	
QUOTE:	
S.O.#	
REF:	SCALE: NONE

UNITED LIGHTING STANDARDS
 A DWH COMPANY

23171 Groesbeck Hwy.
 Warren, MI 48089
 P: (586) 774-5650 | F: (586) 774-5706
www.unitedlightingstandards.com

SOME GEOGRAPHICAL AREAS HAVE SPECIAL WIND CONDITIONS THAT CAN CREATE WIND INDUCED VIBRATIONS CAUSING A FATIGUE PROBLEM. NO METHOD HAS YET BEEN FOUND FOR PREDICTING DESTRUCTIVE LIGHTING POLE VIBRATION. THESE CONDITIONS ARE UNIQUE AND CANNOT BE GUARANTEED AGAINST, AND ARE THE RESPONSIBILITY OF A LOCAL SITE ENGINEER.		
TITLE:		
CATALOG:		
DWG NO: RTHA-43101	SIZE: C	SHEET 1 OF 1

POLE ORDERING GUIDE

ORDER NUMBER TEMPLATE

Example Order Number

Fixture			Catalog Number				Mounting Type	Fixture Mounting Arrangement	Finish	Options			Accessories		
Brand	Product	Number	Design	Mounting Height	Shaft Size	Wall Thickness				Design	Orientation	Height From Base	Design	Orientation	Height From Base
			RPSQ	20	4	11	AB	T2	DB	WB-15	@90	10'	FH	@180	9'

Build Your Order Number

Fixture			Catalog Number				Mounting Type	Fixture Mounting Arrangement	Finish	Options			Accessories		
Brand	Product	Number	Design	Mounting Height	Shaft Size	Wall Thickness				Design	Orientation	Height From Base	Design	Orientation	Height From Base

Mounting Type

AB = Anchor Base
EMB = Embedded (Direct Burial)

Fixture Mounting Arrangement

D1 D4
D2@90 T2
D2@180 T2.5
D3@90 T3
D3@120* T4

*Round poles only

Refer to the Mounting Orientation Guide on the next page of this file.

Finish

WH = White
TWH = Textured White
DB = Dark Bronze
TMB = Textured Medium Bronze
HB = Harvest Bronze
NB = New Bronze
SL = Silver
MGY = Medium Gray
GR = Gray
TGR = Textured Gray
GM = Graphite Metallic
DP = Dark Platinum
MA = Matte Aluminum
PSP = Platinum Silver
BK = Black
TBK = Textured Black
MG = Moss Green

Contact us for custom colors.

Options

CMB = Camera Mounting Bracket
CMP = Camera Mounting Plate
WB-15 = Welded Bracket
WC = Welded Coupling (denote size)
WN = Welded Nipple (denote size)
Festoon = Festoon Provision
CSBC = Custom Steel Base Cover
VD = Vibration Dampener
GFCI/IUC = Ground Fault Circuit Interrupter with In-Use Cover
UL = UL Listed**

*See our online product catalog for complete catalog numbers of these options and accessories.

** UL Listed labeling is available for catalog steel and aluminum poles—both Commercial & Industrial and Roadway. UL Listed labeling is not available for brackets. UL Listing must be specified at the time of order.

Note: N/A = Not Applicable

Accessories

TB = Transformer Base*
ABS-BC = ABS Base Cover*
LW = Lowering Winch
LW-ELECTRIC = Electric Lowering Winch
BA = Banner Arm
FH = Flag Holder
PTTA = Pole Top Tenon Adapter*