



SIGNWAVE® 7 (INDOOR/OUTDOOR)

SW7-SERIES | PIXEL CONTROL
WIDE VIEW FLEXIBLE LIGHTING SYSTEM

Fixture Type: _____

Project: _____

Location: _____

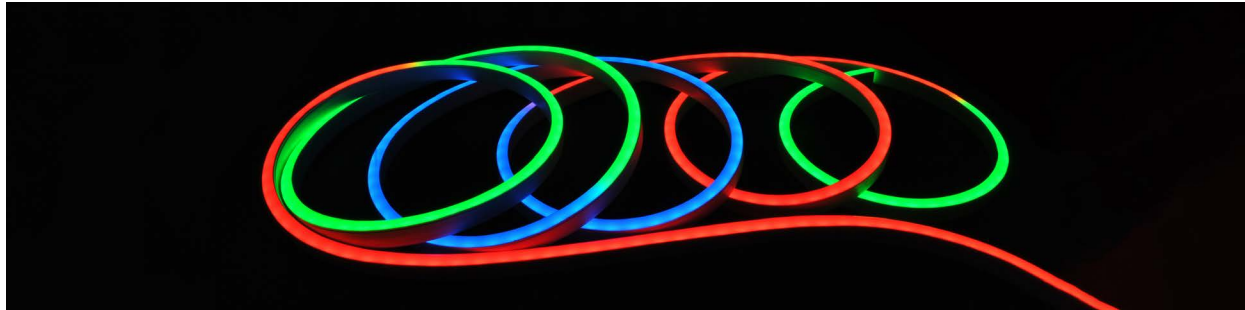

PRODUCT FEATURES

- Digital pixel control RGB
- Dimmable
- 50,000 hour life
- Domed profile for large beam angle
- UL-listed for indoor and outdoor use
- IP67 or IP68 option
- Factory-installed power feed
- Injection-molded flush end caps
- For use with 24V power supplies

SPECIFICATIONS

Series	SW7 - Signwave® 7
Input Voltage	24V DC
Lumens	162 Lm/ft Red / Green / Blue
Wattage	3.7W/ft
Max Run Length	26 ft / 63 pixels
Beam Angle	320°
Dimensions	0.438"(11.5mm) × 1.125"(29mm)
Production Intervals	4.938" (125mm)
Pixel Length	4.938" (125mm)
Control Options	SPI, UCS 2903 IC
Temp Range	-4°F (-20°C) to 113°F (45°C)

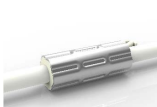
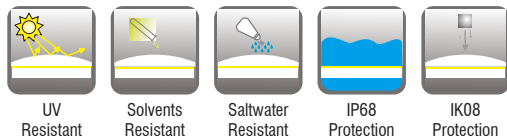

DryWire ferrule located 115mm from the cable connector. Protects against damage from water ingress inside cable wire.

Included in every run.

DOMED PROFILE DIMENSIONS

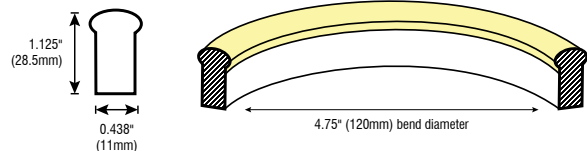

Conforms to ANSI/UL Standard 2108
Certified to CAN/CSA Standard C22.2 No. 250.0





SIGNWAVE® 7 (INDOOR/OUTDOOR)

SW7-SERIES | PIXEL CONTROL | WIDE VIEW FLEXIBLE LIGHTING SYSTEM

IP67 OPTIONS

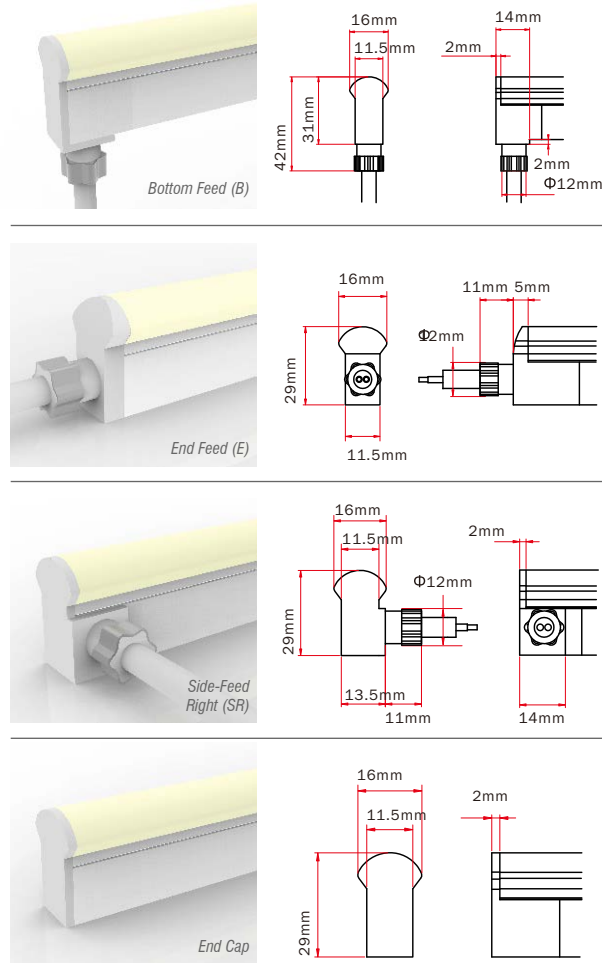

IP68 OPTIONS

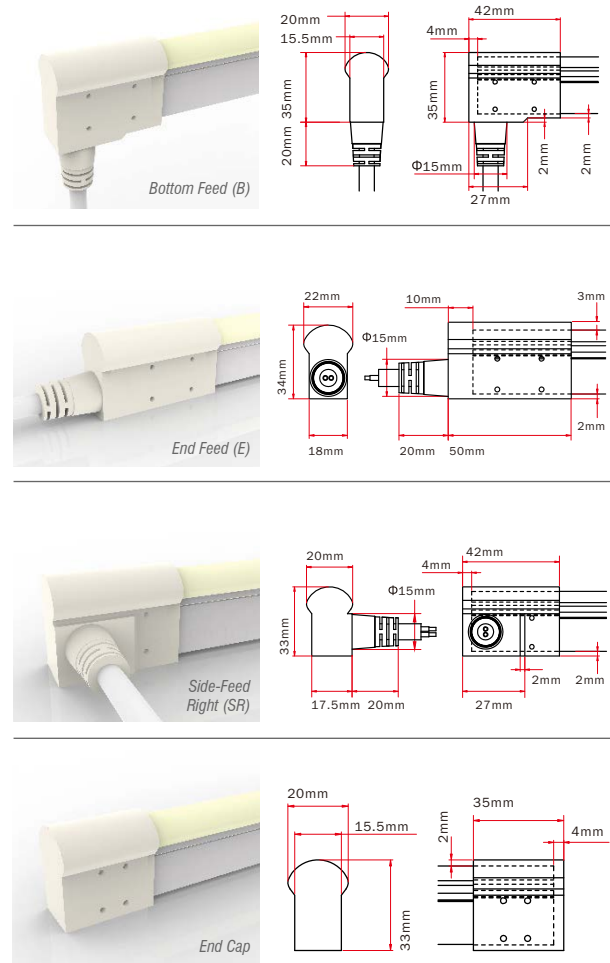

ORDERING INFORMATION

Example: SW7-72-TX-SL-72-IP68

Series	Length (Unlimited)	Color	Feed Point	Feed Length	Rating
SW7		TX			

SW7 - Signwave 7

Inches

TX - Pixel Control

B - Bottom Feed
SL - Side-Feed Left
SR - Side-Feed Right
E - End Feed

S - Standard (118 inch)
Inches - Custom length
(inches).

IP67
IP68



SIGNWAVE® WIDE VIEW ACCESSORIES

FOR SIGNWAVE™ 1, 2, 5, & 7 SERIES

ALUMINUM SERRATED CHANNEL

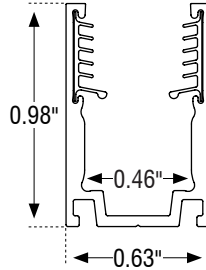
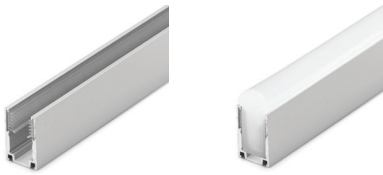

Model	SW-E-AL-CH-SR-2M
Material	Aluminum
Length	78.75" (2m)
Width	0.63" (15.9mm)
Height	0.98" (24.8mm)
Internal Width	0.46" (11.8mm)

ALUMINUM SERRATED CLIP

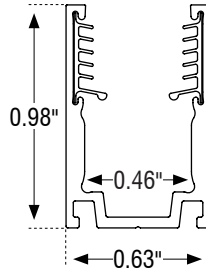
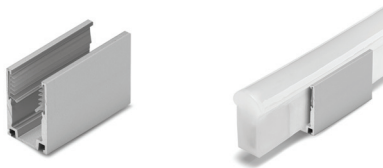

Model	SW-E-CLP-AL-SR
Material	Aluminum
Length	0.79" (20mm)
Width	0.63" (15.9mm)
Height	0.98" (24.8mm)
Internal Width	0.46" (11.8mm)

ALUMINUM SERRATED FLEX CHANNEL

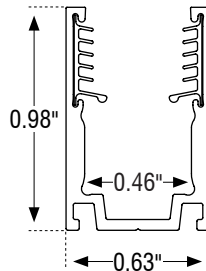
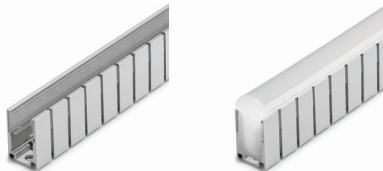

Model	SW-E-CH-AL-FLX-1M
Material	Aluminum
Length	39.3" (1m)
Width	0.63" (15.9mm)
Height	0.98" (24.8mm)
Internal Width	0.46" (11.8mm)

SIDE MOUNTING BRACKET

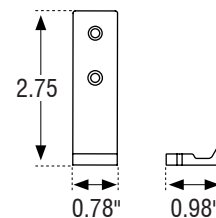

Model	SW-CLP-RA
Material	Aluminum
Length	0.78" (20mm)
Width	0.98" (25mm)
Height	2.75" (70mm)

REQUIRED: Must be paired with channel.