

Project Name:	Type:
Part Number:	Date:

PXCYL CYLINDER 4"

SPECIFICATION FEATURES

- **Mechanical** - Compact fixture body made from die cast aluminum. Proprietary selectable output driver and polycarbonate lens design provide high quality light to compliment any space. Fixture bodies are available in matte black and matte white, or additional customized colors. Available in Surface, Pendant, Swivel, Suspension cable or Wall mount configuration.
- **Electrical** - Two selectable lumen output driver options with SelectDrive technology. The 120V, 50/60 Hz driver is forward or reverse phase dimmable to 5%. The 120-277V, 50/60 Hz driver is 0-10V dimmable to 5% with a low end cutoff and comes with a 12V auxiliary port that provides power for field installed sensors and control modules. Static lumen output driver options include the Lutron 5-Series Ecosystem driver which provides smooth dimming to 5% and the Lutron Hi-Lume 1% EcoSystem driver with Soft-On, Fade-to-Black which dims to 1%. EldoLED ECOdrive and SOLOdrive drivers are available in 0-10V and DALi configurations and dim smoothly to 1% and 0.1% respectively. Enlighted compact sensors and Philips EasySense sensors are field installable and directly integrate with the factory provided Philips Xitanium driver and Sensor Ready bridge.
- **Optical** - Flanged spun aluminum reflector. 45° optical cutoff. Field interchangeable optical lenses. Five beam distributions ranging from 15°-75°. Wall wash field installed accessory. COB LED binned to 3-step SDCM to ensure color uniformity in 2700K, 3000K, 3500K, 4000K or 5000K CCT. Minimum 90 CRI. 97 CRI with TRUE CHROMA available in 3000K only.
- **Thermal** - Die cast heat sink maximizes passive thermal management and achieves an L70 rated lifetime of 50,000 hours. Fixture operating temperature: -22°F to 95°F (-30°C to 35°C).
- **Compliance and Warranty** - ETL Listed for damp location, WET location available for Surface Mount and Wall Mount downlighting under covered ceiling. Complies with FCC 47CFR Part 15B consumer limits for EMI/RFI emissions. 5 year parts warranty for complete fixture. Optional 10 Year Extended Warranty available, subject to same terms, conditions and installation requirements as standard 5 Year Warranty.



081222



BENEFITS

- Get the right amount of light with SelectDrive technology
- Multiple finish and customization available to match any décor
- Surface, Pendant, Cable, Down-wall and Up-wall mounting options are available.
- Field interchangeable optics ensure smooth light levels
- Large variety of dimming and sensor control options

APPLICATIONS

- Retail
- Hospitality
- Residential
- Education
- Healthcare



PXCYL CYLINDER 4"

ORDERING INFORMATION

ORDERING EXAMPLE: PXCYL4/SM/LEM9035/KDIM010UNV/MD/WH/CC

SelectDrive Light Engine

PXCYL	4	/	/	/	/	/	/	/	/	/
Model Series	Size	Mounting	Light Engine	CRI	CCT	Driver	Optical Distribution	Cylinder Finish	Reflector Finish	Options
<input type="checkbox"/> PXCYL PXCYL Cylinder	<input type="checkbox"/> 4 4"	<input type="checkbox"/> SM Surface Mount	<input type="checkbox"/> LES Small Light Engine 500-700-1000 lumens	<input type="checkbox"/> 90 CRI 90+	<input type="checkbox"/> 27 ³ 2700K	<input type="checkbox"/> KDIM120V SelectDrive 120V, 50/60Hz Forward/Reverse phase dimming	<input type="checkbox"/> SP Spot 15° Beam Angle	<input type="checkbox"/> WH Matte White	<input type="checkbox"/> CC Clear	<input type="checkbox"/> WET ⁶ Wet Location Ready
		<input type="checkbox"/> CM ¹ Cable Mount Ready	<input type="checkbox"/> LEM Medium Light Engine 1500-2000-2500 lumens	<input type="checkbox"/> 97 ^{2,3} 97 CRI 3000K TRUE CHROMA	<input type="checkbox"/> 30 3000K	<input type="checkbox"/> KDIM010UNV SelectDrive 120-277V, 50/60Hz 0-10V dimming	<input type="checkbox"/> VN Very Narrow 25° Beam Angle	<input type="checkbox"/> BL Matte Black	<input type="checkbox"/> WH White	For Emergency options please see field installable options below
		<input type="checkbox"/> PM ¹ Pendant Mount Ready			<input type="checkbox"/> 35 3500K		<input type="checkbox"/> NR Narrow 40° Beam Angle	<input type="checkbox"/> CZ ⁴ Customized	<input type="checkbox"/> CZ ⁴ Customized	
		<input type="checkbox"/> WM Wall Mount			<input type="checkbox"/> 40 4000K		<input type="checkbox"/> MD Medium 60° Beam Angle			
		<input type="checkbox"/> WMUP Wall Mount Up lighting			<input type="checkbox"/> 50 ³ 5000K		<input type="checkbox"/> WD Wide 75° Beam Angle			

Fixed Lumen Output Light Engine

PXCYL	4	/	/	/	/	/	/	/	/	/
Model Series	Size	Mounting	Light Engine	CRI	CCT	Driver	Optical Distribution	Cylinder Finish	Reflector Finish	Options
<input type="checkbox"/> PXCYL PXCYL Cylinder	<input type="checkbox"/> 4 4"	<input type="checkbox"/> SM Surface Mount	<input type="checkbox"/> LE05 ⁷ 500 lumens	<input type="checkbox"/> 90 CRI 90+	<input type="checkbox"/> 27 ³ 2700K	<input type="checkbox"/> PSRUNV 0-10V Xitanium Driver + SR Ready Bridge, 120-277V	<input type="checkbox"/> SP Spot 15° Beam Angle	<input type="checkbox"/> WH Matte White	<input type="checkbox"/> CC Clear	<input type="checkbox"/> ES ⁵ Philips EasySense CPM SN200 Ceiling Mount Sensor
		<input type="checkbox"/> CM ¹ Cable Mount Ready	<input type="checkbox"/> LE07 700 lumens	<input type="checkbox"/> 97 ^{2,3} 97 CRI 3000K TRUE CHROMA	<input type="checkbox"/> 30 3000K	<input type="checkbox"/> XT010UNV 0-10V 1% Xitanium Driver, 120-277V	<input type="checkbox"/> VN Very Narrow 25° Beam Angle	<input type="checkbox"/> BL Matte Black	<input type="checkbox"/> WH White	<input type="checkbox"/> ENLS ⁵ -IL Enlighted Two Wire ENLIGHTED ONE Compact Sensor
		<input type="checkbox"/> PM ¹ Pendant Mount Ready	<input type="checkbox"/> LE10 1,000 lumens		<input type="checkbox"/> 35 3500K	<input type="checkbox"/> LUT-SUNV Lutron EcoSystem 5% Dimming, 120-277V	<input type="checkbox"/> NR Narrow 40° Beam Angle	<input type="checkbox"/> CZ ⁴ Customized	<input type="checkbox"/> CZ ⁴ Customized	<input type="checkbox"/> ENLS ⁵ -CL Enlighted Two Wire CONNECTED LIGHTING Compact Sensor
		<input type="checkbox"/> WM Wall Mount	<input type="checkbox"/> LE15 1,500 lumens		<input type="checkbox"/> 40 4000K	<input type="checkbox"/> LUT-1UNV Lutron EcoSystem 1% Dimming, 120-277V	<input type="checkbox"/> MD Medium 60° Beam Angle			<input type="checkbox"/> ENLS ⁵ -IOT Enlighted Two Wire IOT Compact Sensor
		<input type="checkbox"/> WMUP Wall Mount Up lighting	<input type="checkbox"/> LE20 2,000 lumens		<input type="checkbox"/> 50 ³ 5000K	<input type="checkbox"/> LUT-L3DUNV Lutron Hi-Lume 3-Wire 1% Dimming, 120-277V	<input type="checkbox"/> WD Wide 75° Beam Angle			<input type="checkbox"/> WET ⁶ Wet Location Ready
			<input type="checkbox"/> LE25 2,500 lumens			<input type="checkbox"/> ELD-E010UNV EldoLED ECOdrive 0-10V 1%, 120-277V				For Emergency options please see field installable options below
						<input type="checkbox"/> ELD-EDALIUNV EldoLED ECOdrive DALI 1%, 120-277V				
						<input type="checkbox"/> ELD-S010UNV EldoLED SOLOdrive 0-10V 0.1%, 120-277V				
						<input type="checkbox"/> ELD-SDALIUNV EldoLED SOLOdrive DALI 0.1%, 120-277V				
						<input type="checkbox"/> OSRDIM010347V Osram OPTOTRONIC 0-10V 1%, 347V				

¹ Cable and Pendant Mount ready for Stem or Cable Suspension, order Canopy type and length separately. ² TRUE CHROMA only available for 3000K, contact factory for detail and other CCT. ³ Non-stock item: may be subject to extended lead time and minimum order quantity. Please contact factory for details. ⁴ Please contact factory for customized finish color or customized reflectors for feasibility. ⁵ Philips EasySense ceiling mounted sensor is only available with the PSRUNV driver. ⁶ Enlighted Two Wire Compact Sensor with ceiling mount is only available with the PSRUNV driver. ⁷ LE05 is not available with LUT-SUNV. ⁸ WET location are available only for Surface Mounted and Wall Mount downlighting under covered ceiling.



PXCYL CYLINDER 4"

MOUNTING AND CANOPY ACCESSORIES AND OPTIONS

ORDERING EXAMPLE: CABLECPY/WH/50/18/3

CABLECPY / / /			
Model Series	Color	Length ²	Cord Type
<input type="checkbox"/> CABLECPY¹ Cable mount canopy for flat and slope ceiling (use with CM mounting only)	<input type="checkbox"/> WH White	<input type="checkbox"/> 50 Adjustable length up to 50" max.	<input type="checkbox"/> 18/3 3 x 18 AWG, for non Dimming or TRIAC/ELV
	<input type="checkbox"/> BL Black	<input type="checkbox"/> 72 Adjustable length up to 72" max.	<input type="checkbox"/> 18/3-22/2 3 x 18 AWG, 2 x 22 AWG (purple, pink), for 0-10V control and dimming and/or to connect a field installable micro inverter (FHUPS1-UNV-25L-SD)
	<input type="checkbox"/> CZ³ Customized	<input type="checkbox"/> 100 Adjustable length up to 100" max.	<input type="checkbox"/> 18/4-22/2 4 x 18 AWG, 2 x 22 AWG, for emergency wiring with field installable EM driver (FHSCP-UNV-10.7WL(-CEC))
		<input type="checkbox"/> CZ³ Customized	

ORDERING EXAMPLE: STEMSCCPY/3-8/WH/12/18/3

STEMSCCPY/3-8/WH/12/18/3 / / /			
Model Series	Color	Length ²	Cord Type
<input type="checkbox"/> STEMSCCPY/3-8¹ Pendant Canopy with 3/8 IPS Stem for flat and slope ceiling up to 45° (Use with PM only)	<input type="checkbox"/> WH White	<input type="checkbox"/> 12 12" long	<input type="checkbox"/> 18/3 3 x 18 AWG, for non Dimming or TRIAC/ELV
<input type="checkbox"/> STEMCDTFCCPY/3-8⁴ Jbox Cover Canopy with 3/8 IPS Stem, for flat ceiling with 4x side conduits pass (Use with PM only)	<input type="checkbox"/> BL Black	<input type="checkbox"/> 24 24" long	<input type="checkbox"/> 18/3-22/2 3 x 18 AWG, 2 x 22 AWG (purple, pink), for 0-10V control and dimming and/or to connect a field installable micro inverter (FHUPS1-UNV-25L-SD)
		<input type="checkbox"/> 36 36" long	<input type="checkbox"/> 18/4-22/2 4 x 18 AWG, 2 x 22 AWG, for emergency wiring with field installable EM driver (FHSCP-UNV-10.7WL(-CEC))
		<input type="checkbox"/> 48 48" long	
		<input type="checkbox"/> CZ³ Customized	

¹ The Stem and cable canopies can be used for both plane and slope ceiling. ² Cord length will be approximately 12" longer than cable or Stem.

³ Please contact factory for customized color and length. ⁴ Stem Conduit Canopy only available for flat ceiling.

LINE DRAWINGS

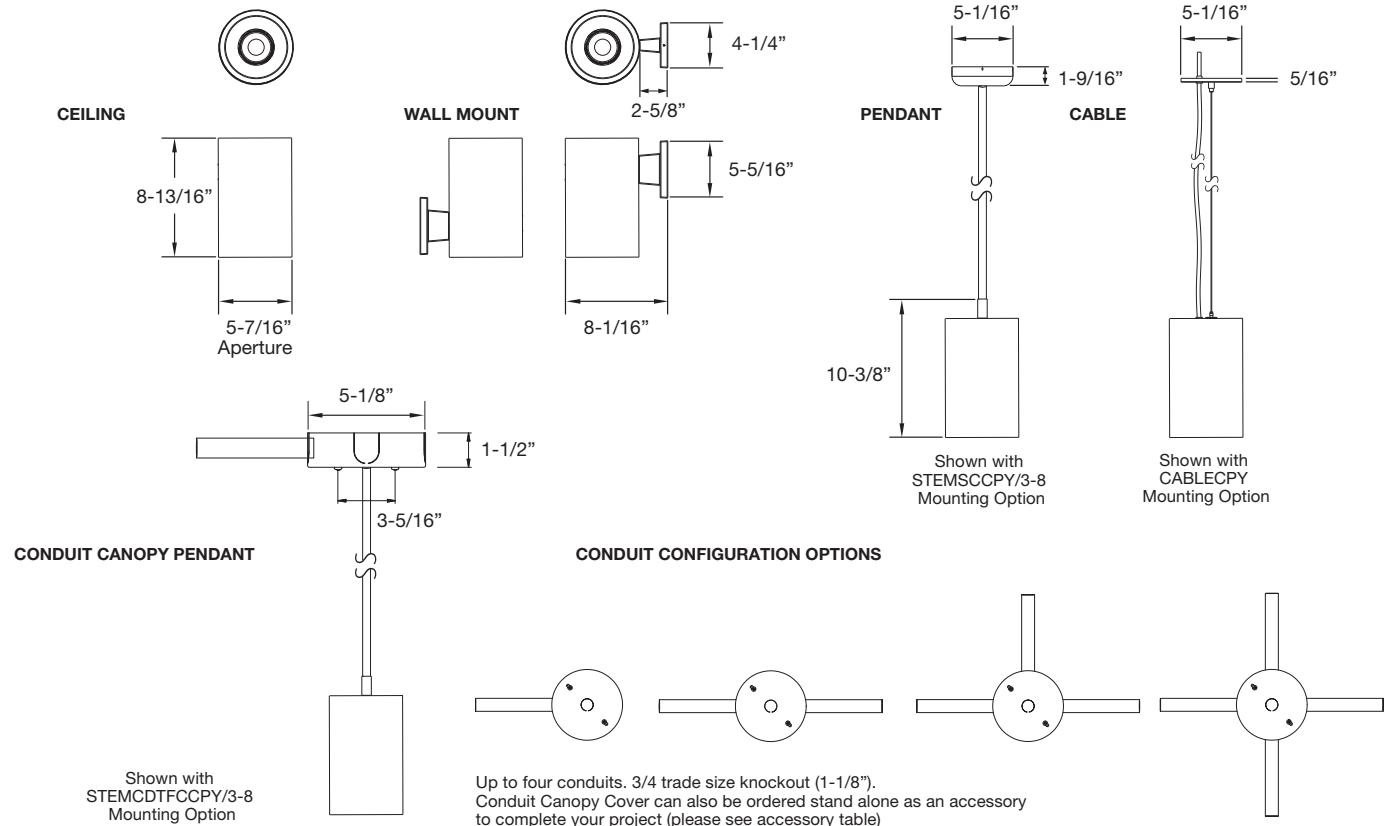

PXCYL CYLINDER 4"



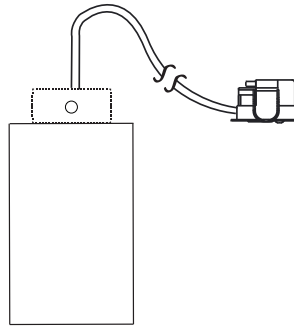

LINE DRAWINGS WITH OPTIONS

WITH SENSOR



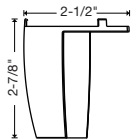

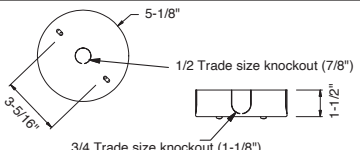
Philips EasySense sensor shown in Surface mount installation.
 Enlighted compact sensor also available.
 Consult factory for additional options.

ACCESSORY ORDERING INFORMATION

Product	Model	Description	Pictures	Dimensions
98079	ADWAW	Wall Wash (Field Installed on Module)		
36761	CONDUITCPYKIT/WH	White finish, decorative Jbox cover, with 4 side conduit pass-through.		
36762	CONDUITCPYKIT/BL	Black finish, decorative Jbox cover, with 4 side conduit pass-through.		

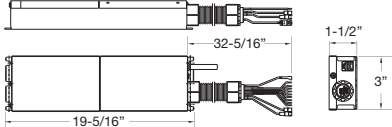
FIELD INSTALLABLE EMERGENCY UNIT ORDERING INFORMATION

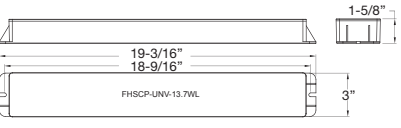
Product	Model	Description	Picture	Dimension
FHUPS1-UNV-25L-SD	FHUPS1-UNV-25L-SD	25W Emergency Micro Inverter for field installation to use with 0-10V Driver options. 100-277VAC (up to 150W with use of 0-10V dimming). CEC Compliant.		
FHSCP-UNV-10.7WL	FHSCP-UNV-10.7WL	10.7W Emergency Driver for field installation to use with 120V and non 0-10V dimmable input Driver options. CEC Compliant.		



PXCYL CYLINDER 4"

LINE DRAWINGS WITH OPTIONS

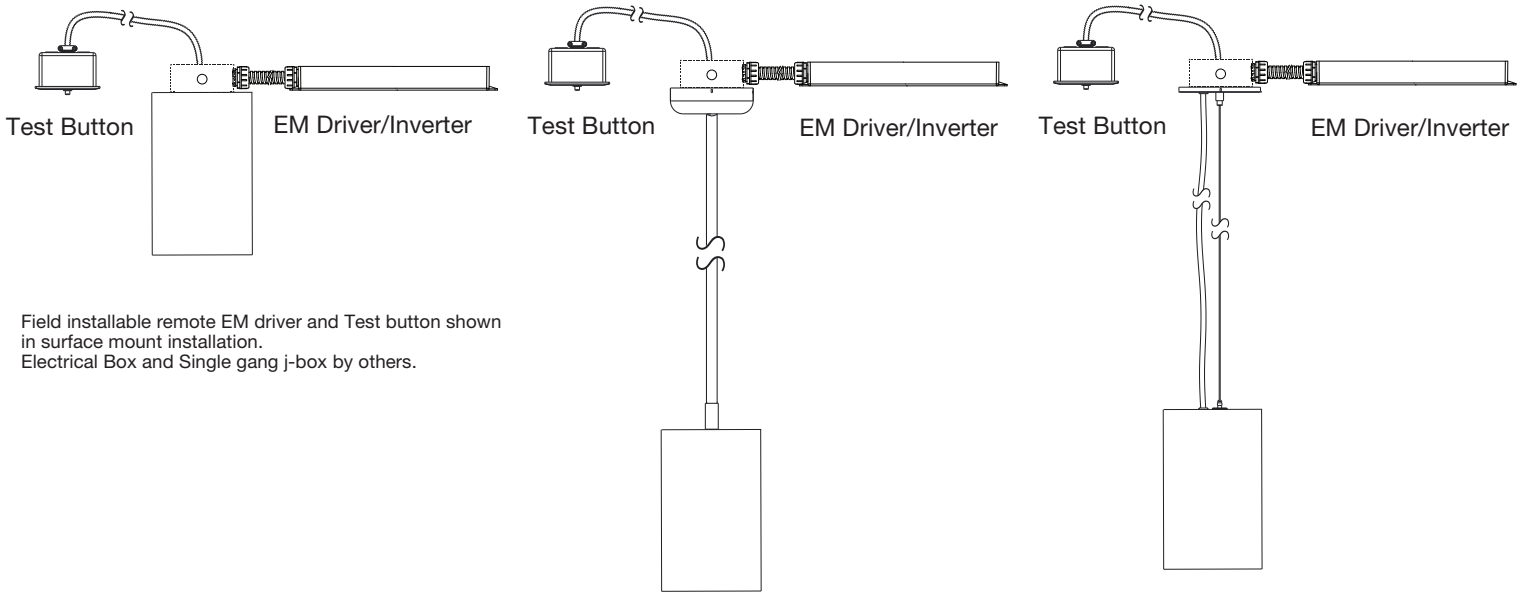

Field installable remote EM driver and Test button shown in surface mount installation. Electrical Box and Single gang j-box by others.

Field installable remote EM driver and Test button shown in Pendant Mount installation. Need to be use with 18-3/2-22 Type cord for FHUPS1-UNV-25L-SD or 18-4/22-2 for FHSCP-UNV-10.7WL/FHSCP-UNV-10.7WL-CEC Electrical Box and Single gang j-box by others.

Field installable remote EM driver and Test button shown in Cable Mount installation. Need to be use with 18-3/2-22 Type cord for FHUPS1-UNV-25L-SD or 18-4/22-2 for FHSCP-UNV-10.7WL/FHSCP-UNV-10.7WL-CEC Electrical Box and Single gang j-box by others.

FHUPS1-UNV-25L-SD FIELD WIRING DIAGRAM INSTALLATION

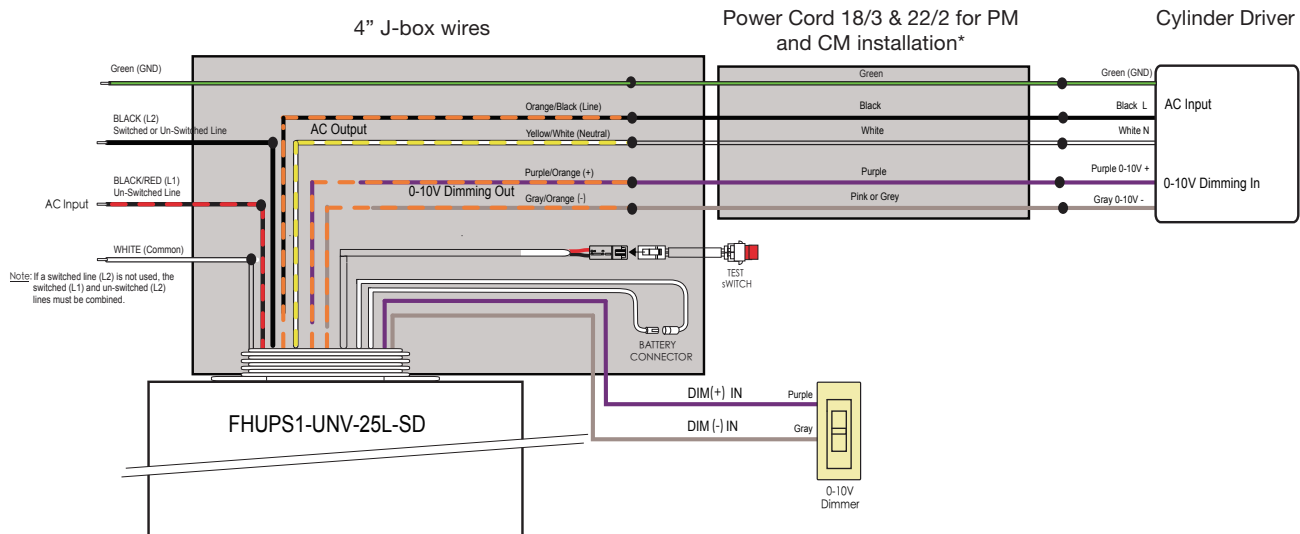

*For SM installation power cord is not needed connect the EM driver directly to the Driver.



PXCYL CYLINDER 4"

FHSCP-UNV-10.7WL(-CEC) FIELD WIRING DIAGRAM INSTALLATION

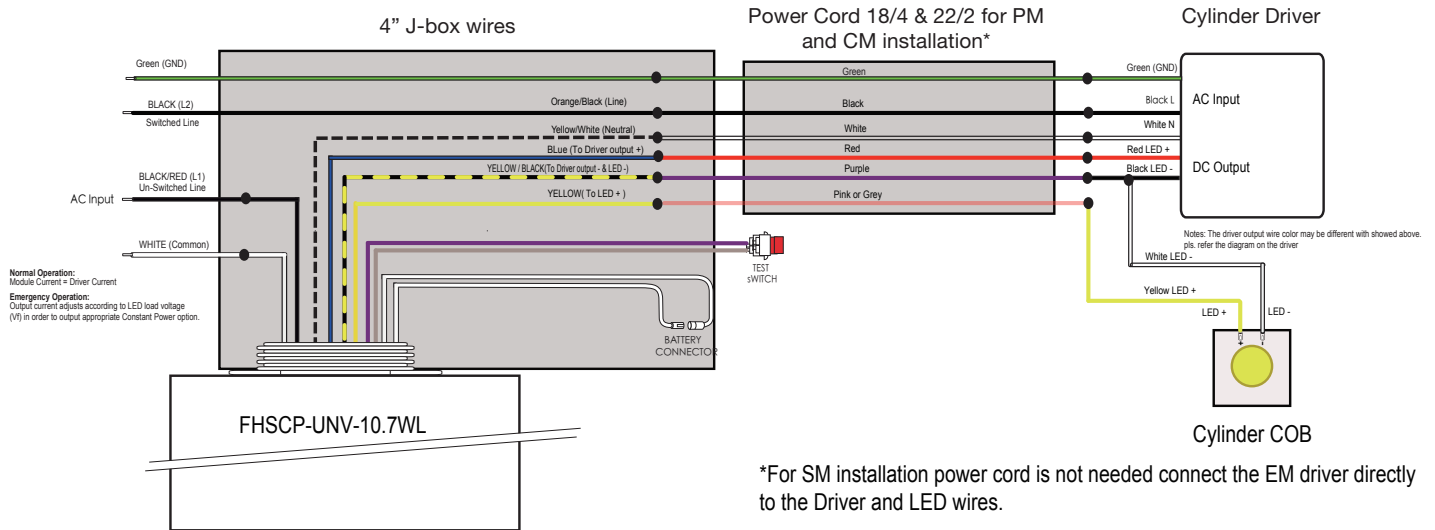

TECHNICAL INFORMATION						
Light Engine	Input Voltage	Input Frequency	Input Current	Max. Input Power	THD Power	Power Factor
LES	120-277V	50-60Hz	0.115 / 0.047A	13W	<20%	>0.9
LEM			0.270 / 0.114A	31.5W		
LE05			0.056 / 0.024A	6.5W		
LE07			0.073 / 0.034A	8.5W		
LE10			0.112 / 0.047A	13W		
LE15			0.154 / 0.068A	18W		
LE20			0.218 / 0.092A	25.5W		
LE25			0.269 / 0.116A	31.5W		



PXCYL CYLINDER 4"

NOMINAL PERFORMANCE

LES (LE05 / LE07 / LE10) - Low / Medium / High - 6.5 / 8.5 / 12.5W

CCT	2700K			3000K			3500K			4000K			5000K		
Output**	Low	Medium	High	Low	Medium	High	Low	Medium	High	Low	Medium	High	Low	Medium	High
Finish	lm LPW	lm LPW	lm LPW	lm LPW	lm LPW	lm LPW	lm LPW	lm LPW	lm LPW	lm LPW	lm LPW	lm LPW	lm LPW	lm LPW	lm LPW
Clear Diffuse	500 77	700 82	1,000 80	525 81	735 86	1,050 84	550 85	770 91	1,100 88	575 88	805 95	1,150 92	580 89	810 95	1,165 93
White Finish	500 77	700 82	1,000 80	525 81	735 86	1,050 84	550 85	770 91	1,100 88	575 88	805 95	1,150 92	580 89	810 95	1,165 93

LEM (LE15 / LE20 / LE25) - Low / Medium / High - 18.0 / 25.5 / 31.5W

CCT	2700K			3000K			3500K			4000K			5000K		
Output**	Low	Medium	High	Low	Medium	High	Low	Medium	High	Low	Medium	High	Low	Medium	High
Finish	lm LPW	lm LPW	lm LPW	lm LPW	lm LPW	lm LPW	lm LPW	lm LPW	lm LPW	lm LPW	lm LPW	lm LPW	lm LPW	lm LPW	lm LPW
Clear Diffuse	1,600 89	2,125 83	2,500 79	1,632 91	2,169 85	2,550 81	1,664 92	2,210 87	2,600 83	1,696 94	2,253 88	2,650 84	1,713 95	2,275 89	2,677 85
White Finish	1,600 89	2,125 83	2,500 79	1,632 91	2,169 85	2,550 81	1,664 92	2,210 87	2,600 83	1,696 94	2,253 88	2,650 84	1,713 95	2,275 89	2,677 85

** Lumen output are based on rated lumens, for exact value please refer to the IES files

PHOTOMETRY

PXCYL4/xx/LES9035/KDIM010UNV/SP/xx/CC (High Output)

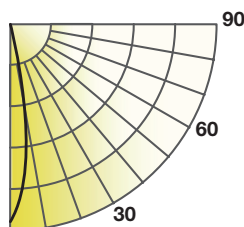

Lumens: 1,005 lm
CBCP: 4,803 cd
Power: 13 W
Efficacy: 84 lm/W
CRI: 92
Spacing Criteria: 0.3
Beam Angle: 18°

Candlepower Distribution	
Angle (°)	Average (cd)
10	1,959
20	542
30	315
40	163
50	52
60	10
70	2
80	0
90	0

Initial Footcandles		
Height (ft)	Fc	Diameter (ft)
8	45	3
10	29	3
12	20	4
15	13	5
20	7	6

Zonal Lumen Summary		
Zone	Lumens	%Fixt
0-30	749	75
0-40	895	89
0-60	998	99
0-90	1,004	100

PXCYL4/xx/LES9035/KDIM010UNV/VN/xx/CC (High Output)

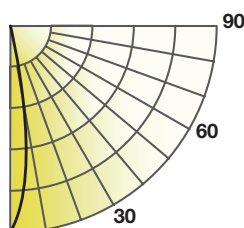

Lumens: 1,239 lm
CBCP: 4,968 cd
Power: 13 W
Efficacy: 103 lm/W
CRI: 92
Spacing Criteria: 0.4
Beam Angle: 22°

Candlepower Distribution	
Angle (°)	Average (cd)
10	2,590
20	1,142
30	329
40	71
50	21
60	4
70	1
80	0
90	0

Initial Footcandles		
Height (ft)	Fc	Diameter (ft)
8	60	3
10	38	4
12	27	5
15	17	6
20	10	8

Zonal Lumen Summary		
Zone	Lumens	%Fixt
0-30	1,102	89
0-40	1,193	96
0-60	1,236	100
0-90	1,239	100



PXCYL CYLINDER 4"

PHOTOMETRY

PXCYL4/xx/LES9035//KDIM010UNV/NR/xx/CC (High Output)

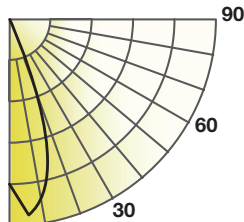

Lumens: 1,242 lm
CBCP: 2,289 cd
Power: 13 W
Efficacy: 104 lm/W
CRI: 92
Spacing Criteria: 0.7
Beam Angle: 44°

Candlepower Distribution	
Angle (°)	Average (cd)
10	2,184
20	1,428
30	442
40	72
50	15
60	3
70	1
80	0
90	0

Initial Footcandles		
Height (ft)	Fc	Diameter (ft)
8	51	6
10	32	8
12	23	10
15	14	12
20	8	16

Zonal Lumen Summary		
Zone	Lumens	%Fixt
0-30	1,095	88
0-40	1,205	97
0-60	1,240	100
0-90	1,241	100

PXCYL4/xx/LES9035//KDIM010UNV/MD/xx/CC (High Output)

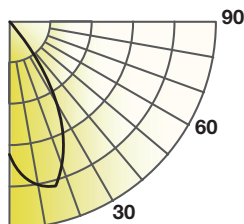

Lumens: 1,254 lm
CBCP: 1,362 cd
Power: 13 W
Efficacy: 105 lm/W
CRI: 92
Spacing Criteria: 0.95
Beam Angle: 65°

Candlepower Distribution	
Angle (°)	Average (cd)
10	1,237
20	1,228
30	711
40	234
50	26
60	5
70	1
80	0
90	0

Initial Footcandles		
Height (ft)	Fc	Diameter (ft)
8	29	10
9	23	12
10	18	13
12	13	15
15	8	19

Zonal Lumen Summary		
Zone	Lumens	%Fixt
0-30	926	74
0-40	1,176	94
0-60	1,250	100
0-90	1,253	100

PXCYL4/xx/LES9035//KDIM010UNV/WD/xx/CC (High Output)

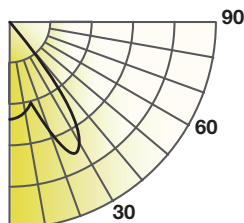

Lumens: 1,292 lm
CBCP: 1,018 cd
Power: 13 W
Efficacy: 108 lm/W
CRI: 92
Spacing Criteria: 1.2
Beam Angle: 84°

Candlepower Distribution	
Angle (°)	Average (cd)
10	649
20	739
30	1,000
40	448
50	39
60	8
70	8
80	0
90	0

Initial Footcandles		
Height (ft)	Fc	Diameter (ft)
8	15	14
10	10	18
12	7	22
15	4	27
20	2	36

Zonal Lumen Summary		
Zone	Lumens	%Fixt
0-30	669	52
0-40	1,116	86
0-60	1,285	100
0-90	1,290	100



PXCYL CYLINDER 4"

PHOTOMETRY

PXCYL4/xx/LEM9035/KDIM010UNV/SP/xx/CC (High Output)

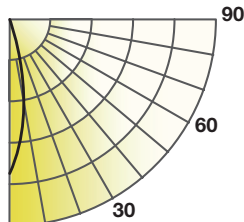

Lumens: 2,311 lm
CBCP: 11,054 cd
Power: 30 W
Efficacy: 73 lm/W
CRI: 92
Spacing Criteria: 0.3
Beam Angle: 18°

Candlepower Distribution	
Angle (°)	Average (cd)
10	453
20	123
30	73
40	38
50	12
60	1
70	1
80	0
90	0

Initial Footcandles		
Height (ft)	Fc	Diameter (ft)
8	11	3
10	7	3
12	5	4
15	3	5
20	2	6

Zonal Lumen Summary		
Zone	Lumens	%Fixt
0-30	1,718	74
0-40	2,054	89
0-60	2,293	99
0-90	2,309	100

PXCYL4/xx/LEM9035/KDIM010UNV/VN/xx/CC (High Output)

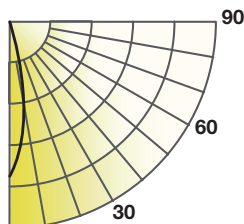

Lumens: 2,849 lm
CBCP: 11,431 cd
Power: 30 W
Efficacy: 91 lm/W
CRI: 92
Spacing Criteria: 0.4
Beam Angle: 22°

Candlepower Distribution	
Angle (°)	Average (cd)
10	597
20	261
30	75
40	16
50	5
60	1
70	0
80	0
90	0

Initial Footcandles		
Height (ft)	Fc	Diameter (ft)
8	14	3
10	9	4
12	6	5
15	4	6
20	2	8

Zonal Lumen Summary		
Zone	Lumens	%Fixt
0-30	2,530	89
0-40	2,738	96
0-60	2,840	100
0-90	2,847	100

PXCYL4/xx/LEM9035/KDIM010UNV/NR/xx/CC (High Output)

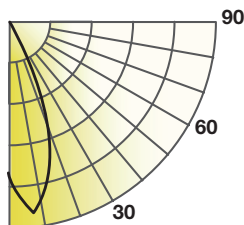

Lumens: 2,886 lm
CBCP: 5,316cd
Power: 30 W
Efficacy: 91 lm/W
CRI: 92
Spacing Criteria: 0.7
Beam Angle: 44°

Candlepower Distribution	
Angle (°)	Average (cd)
10	5,067
20	3,327
30	1,021
40	168
50	35
60	8
70	2
80	0
90	0

Initial Footcandles		
Height (ft)	Fc	Diameter (ft)
8	118	6
10	75	8
12	52	10
15	33	12
20	19	16

Zonal Lumen Summary		
Zone	Lumens	%Fixt
0-30	2,540	88
0-40	2,797	97
0-60	2,879	100
0-90	2,884	100



PXCYL CYLINDER 4"

PHOTOMETRY

PXCYL4/xx/LEM9035/KDIM010UNV/MD/xx/CC (High Output)

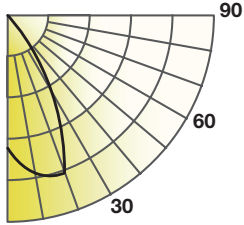

Lumens: 2,877 lm
CBCP: 3,117 cd
Power: 30 W
Efficacy: 91 lm/W
CRI: 92
Spacing Criteria: 1.0
Beam Angle: 65°

Candlepower Distribution	
Angle (°)	Average (cd)
10	2,826
20	2,816
30	1,630
40	541
50	60
60	12
70	3
80	1
90	0

Initial Footcandles		
Height (ft)	Fc	Diameter (ft)
8	66	10
10	42	13
12	29	15
15	19	19
20	10	26

Zonal Lumen Summary		
Zone	Lumens	%Fixt
0-30	2,121	74
0-40	2,695	94
0-60	2,865	100
0-90	2,874	100

PXCYL4/xx/LEM9035/KDIM010UNV/WD/xx/CC (High Output)

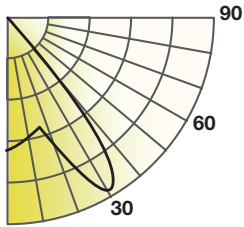

Lumens: 2,970 lm
CBCP: 2,332 cd
Power: 30 W
Efficacy: 95 lm/W
CRI: 92
Spacing Criteria: 1.2
Beam Angle: 84°

Candlepower Distribution	
Angle (°)	Average (cd)
10	1,497
20	1,705
30	2,300
40	1,026
50	91
60	18
70	5
80	2
90	0

Initial Footcandles		
Height (ft)	Fc	Diameter (ft)
8	35	14
10	22	18
12	15	22
15	10	27
20	6	36

Zonal Lumen Summary		
Zone	Lumens	%Fixt
0-30	1,535	52
0-40	2,561	86
0-60	2,951	99
0-90	2,965	100

Note: All rights reserved. All sizes and specifications are subject to change at any time without notice.