

Project Name:	Type:
Part Number:	Date:

THINFIT 4" COMMERCIAL DOWNLIGHT

SPECIFICATION FEATURES

- **Mechanical** - Shallow die cast aluminum heat sink with a low profile external driver is ideal for new or remodel construction. Two rugged spring clips allow for both easy installation and field accessibility below the ceiling.
- **Electrical** - Externally mounted driver, 120 - 277V voltage, 50/60Hz, 0 - 10V dimming to 10%. Quick connect electrical connect in metal clad cable. Go to www.greencreative.com for complete dimmer compatibility list.
- **Optical** - Edge lighting technology featuring a PMMA light guide plate and smooth polycarbonate lens ensures an even light emitting surface. Available in 3000K, 3500K and 4000K with a minimum of 90 CRI.
- **Thermal** - Die cast aluminum heat sink with its edge lighting design maximizes thermal dissipation. L70 rated lifetime of 50,000 hours. Fixture operating temperature: -4°F to 95°F (-25°C to 35°C)
- **Compliance and warranty** - ETL Classified and Listed for wet location. Certified air-tight per ASTM 283-04, IC rated for direct contact with insulation. 5 year parts warranty for complete fixture.



041621



BENEFITS

- Quick and easy installation with spring action clip
- External driver with quick connector for easy wiring
- Suitable for shallow ceiling applications
- Install almost everywhere with Wet Location, IC and Air-tight ratings
- Edge lighting technology for gentle and smooth diffusion

APPLICATIONS

- Commercial
- Residential
- Educational
- Hospitality
- Retail

ORDERING INFORMATION

Series	Size	CRI	CCT	Driver
<input checked="" type="checkbox"/> 10NCDL New Construction Downlight 10W	<input checked="" type="checkbox"/> R4DIM 4"	<input checked="" type="checkbox"/> 9 CRI 90	<input type="checkbox"/> 30 3000K <input type="checkbox"/> 35 3500K <input type="checkbox"/> 40 4000K	<input checked="" type="checkbox"/> 277V / EXT 120 - 277V, 0-10V Dimmable to 10%

LINE DRAWINGS

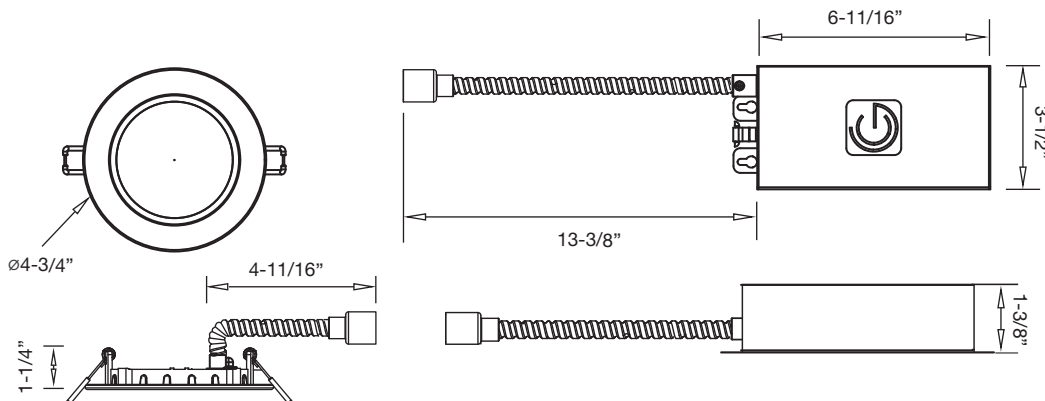

Ceiling Cutout	
Minimum	Maximum
$\varnothing 4-1/16"$	$\varnothing 4-3/8"$



THINFIT 4" COMMERCIAL DOWNLIGHT

TECHNICAL INFORMATION

Dimming	Input Voltage	Input Frequency	Input Current	Input Power	THD Power	Power Factor
0-10V	120-277V	50 / 60Hz	0.08A	10W	<20%	>0.9

PHOTOMETRY

10NCDLR4DIM/935/277V/EXT

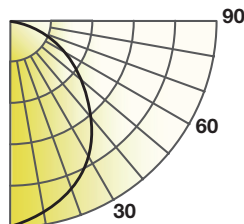

Lumens: 769 lm
 Power: 9 W
 Efficacy: 84 lm/W
 CRI: 90+
 Spacing Criteria: 1.26
 Beam Angle: 100°

Candlepower Distribution	
Angle (°)	Average (cd)
0	265
5	264
15	255
25	237
35	211
45	180
55	142
65	101
75	57
85	13
90	0

Initial Footcandles		
Height (ft)	Fc	Diameter (ft)
8	4	25
9	3	28
10	3	31
12	2	37
15	1	46

Zonal Lumen Summary		
Zone	Lumens	%Fixture
0-30	208	27
0-40	338	44
0-60	600	78
0-90	769	100











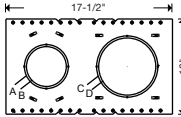
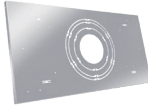
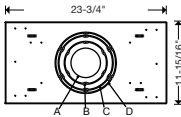

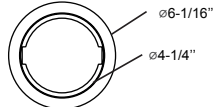
Coefficient		
3000K	3500K	4000K
0.94	1.00	1.02

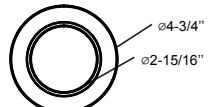
PERFORMANCE

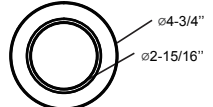
10NCDLR4DIM/9xx/277V/EXT

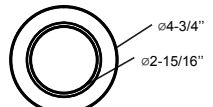
	3000K	3500K	4000K
CCT	3000K	3500K	4000K
Lumens	726	769	781
LPW	79	84	85

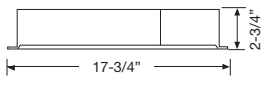
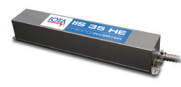
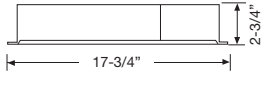
THINFIT 4" COMMERCIAL DOWNLIGHT

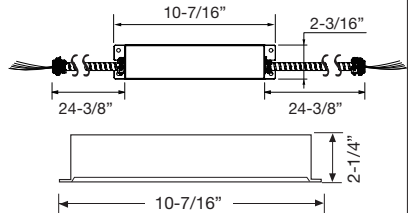
ACCESSORY ORDERING INFORMATION				
Product	Model	Description	Pictures	Dimensions
98280	NCDL46RPLATE	4" & 6" THINFIT EXT Series New Construction Plate for Stud/Joist Mounting		 A: Ø4-5/8" B: Ø4-3/16" C: Ø6-7/16" D: Ø6"
98501	NCPLATE/T4689	New Construction or Remodel Plate for T-Grid Ceilings		 A: Ø4-5/16" B: Ø6-5/16" C: Ø8-1/16" D: Ø9"
97847	DLNC4GOOF/R	4" THINFIT EXT Series GOOF RING		 Ø6-1/16" Ø4-1/4"
98345	NCDLR4TRIMBL	4" THINFIT EXT Series Black Trim		 Ø4-3/4" Ø2-15/16"
98346	NCDLR4TRIMBN	4" THINFIT EXT Series Brushed Nickel Trim		 Ø4-3/4" Ø2-15/16"
98347	NCDLR4TRIMBZ	4" THINFIT EXT Series Bronze Trim		 Ø4-3/4" Ø2-15/16"
58012	35EMINVERTER	35W Emergency Inverter (Field Installation)		 17-3/4" 2-3/4"
58013	35EMINVERTER/CEC	California Title 20 Compliant 35W Emergency Inverter (Field Installation)		 17-3/4" 2-3/4"
98003	23EMDRIVER	California Title 20 Compliant 23W Emergency LED Driver (Field Installation)		 10-7/16" 2-3/16" 24-3/8" 24-3/8" 2-1/4"

ORDERING GUIDE	
Product	Model
98214	10NCDLR4DIM/930/277V/EXT
98215	10NCDLR4DIM/935/277V/EXT
98216	10NCDLR4DIM/940/277V/EXT

Note: All rights reserved. All sizes and specifications are subject to change at any time without notice.