

Project Name:	Type:
Part Number:	Date:

INNOFIT 8" COMMERCIAL DOWNLIGHT

SPECIFICATION FEATURES

- **Mechanical** - INNOFIT, with integrated driver, retrofits existing commercial housings and is field accessible from below the ceiling. Stainless steel spring action clips accommodate 1/2" to 2" ceiling thicknesses.
- **Electrical** - Field select from three lumen outputs using SelectDrive technology. Universal 120-277V, 50/60 Hz drivers. Non-dimmable.
- **Optical** - Self flanged, spun aluminum reflector in matte white finish. High resistance polycarbonate optical lens, with smooth diffusion. 90° beam angle. High end white finish polycarbonate baffle trim for pleasant aesthetic. Available in 2700K, 3000K, 3500K or 4000K, with Minimum 80CRI.
- **Thermal** - Die cast heat sink maximizes passive thermal management and achieves a L70 rated lifetime of 40,000 hours. Fixture Operating Temperature: -13°F to 95°F (-25°C to 35°C)
- **Compliance and Warranty** - cULus Listed and Classified for damp locations. Not for use where directly exposed to weather or water. 5 year parts warranty for complete fixture.



052421



BENEFITS

- Field select lumen output with SelectDrive
- Quick and easy installation with spring action clips
- Universal housing compatibility
- Universal 120-277V, 50/60 Hz drivers
- Available in 2700K, 3000K, 3500K & 4000K CCT

APPLICATIONS

- Commercial
- Educational
- Retail
- Hospitality

ORDERING INFORMATION

Series	Size	CRI	CCT	Dimming
<input checked="" type="checkbox"/> 27CDLA Commercial Downlight 27W Adjustable	<input checked="" type="checkbox"/> 8 8"	<input checked="" type="checkbox"/> 8 CRI 80	<input type="checkbox"/> 27 2700K	<input checked="" type="checkbox"/> 277V 120-277V Non-Dimmable
			<input type="checkbox"/> 30 3000K	
			<input type="checkbox"/> 35 3500K	
			<input type="checkbox"/> 40 4000K	

LINE DRAWINGS

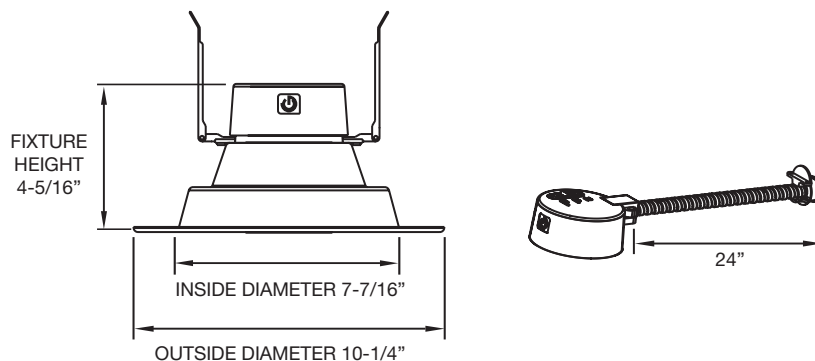

Ceiling Cutout	
Minimum	Maximum
Ø7-9/16"	Ø9-3/8"

New Construction Frame Ceiling Cutout	
Minimum	Maximum
Ø8-1/16"	Ø8-13/16"



INNOFIT 8" COMMERCIAL DOWNLIGHT

TECHNICAL INFORMATION

Dimming	Input Voltage	Input Frequency	Input Current	Input Power	THD Power	Power Factor
Non Dimmable	120-277V	50 / 60Hz	0.23 / 0.16 / 0.1A	12 / 19 / 27W	<20%	>0.9

PHOTOMETRY

27CDLA8/835/277V (HIGH LUMEN OUTPUT SETTING)

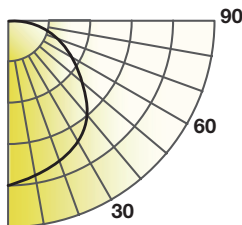

Lumens: 2136 lm
 Power: 26 W
 Efficacy: 81 lm/W
 CRI: 80+
 Spacing Criteria: 1.23
 Beam Angle: 107°

Candlepower Distribution	
Angle (°)	Average (cd)
0	827
5	822
15	788
25	721
35	629
45	520
55	386
65	238
75	88
85	10
90	0

Initial Footcandles		
Height (ft)	Fc	Diameter (ft)
8	19	16
9	15	18
10	12	20
12	9	24
15	5	30

Zonal Lumen Summary		
Zone	Lumens	%Fixture
0-30	633	30
0-40	927	48
0-60	1,680	83
0-90	2,136	100

Lumen Output Coefficient				
CCT	2700K	3000K	3500K	4000K
Low Lumen output	0.48	0.51	0.53	0.54
Med Lumen output	0.70	0.75	0.77	0.78
High Lumen output	0.91	0.97	1.00	1.02

PERFORMANCE

27CDLA8/8xx/277V











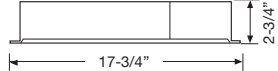

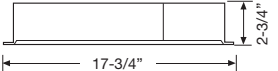
CCT	2700K			3000K			3500K			4000K		
	Low	Med	High	Low	Med	High	Low	Med	High	Low	Med	High
Output												
Lumens	1,033	1,501	1,949	1,098	1,595	2,071	1,132	1,645	2,136	1,151	1,672	2,171
LPW	86	79	72	91	84	77	94	87	79	96	88	80

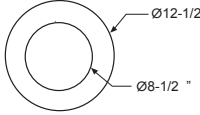
10 YEAR EXTENDED WARRANTY

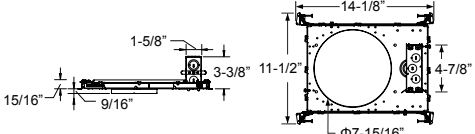
Model	INFT8/10YEARWARRANTY

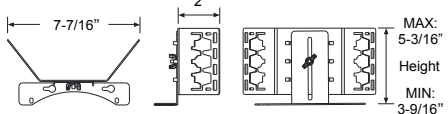

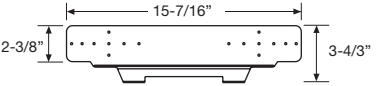
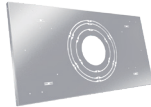
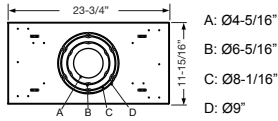
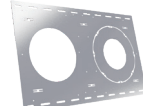
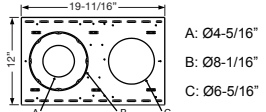
INNOFIT 8" COMMERCIAL DOWNLIGHT

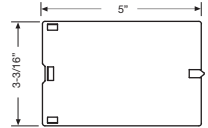
ACCESSORY ORDERING INFORMATION				
Product	Model	Description	Pictures	Dimensions
58012	35EMINVERTER	Emergency Inverter 35W		
58013	35EMINVERTER/CEC	California Title 20 Compliant 35W Emergency Inverter		
98567	GOOFRING8	8" Goof Ring - Outer Diameter 12-1/2"		
35123	NCFJB8	New Construction Frame for T-Grid ceilings and stud/joist mounting		
35126	NCFBFB	Field Installable Butterfly Brackets For New Construction Frame		
35125	NCFEMB	Field Installable Emergency Bracket For New Construction Frame		
98501	NCPLATE/T4689	New Construction Plate for T-Grid ceilings		
98502	NCPLATE468	New Construction Plate for Stud/Joist ceilings		
98583	NCPLATEJB	Junction box for New Construction Plates		



INNOFIT 8" COMMERCIAL DOWNLIGHT

ORDERING GUIDE

Product	Model
57873	27CDLA8/827/277V
57874	27CDLA8/830/277V
57875	27CDLA8/835/277V
57876	27CDLA8/840/277V

Note: All rights reserved. All sizes and specifications are subject to change at any time without notice.