

Project Name:	Type:
Part Number:	Date:

# SELECTFIT 8" RETROFIT DOWNLIGHT

## SPECIFICATION FEATURES

- **Mechanical** - SELECTFIT, with integrated driver, retrofits existing commercial housings and is field accessible from below the ceiling. Stainless steel spring action clips accommodate 1/2" to 2" ceiling thicknesses.
- **Electrical** - Field select from three lumen outputs using SelectDrive technology. Universal 120-277V or 120V only, 50/60 Hz drivers available. Universal 0-10V drivers dimmable to 5% with low end cutoff. 120V drivers are dimmable to 10% using TRIAC or ELV dimmers.
- **Optical** - Self flanged spun aluminum reflector, painted matte white. Optional clear aluminum trim insert available. High resistance polycarbonate optical lens, with smooth diffusion. 90° beam angle. Field select color temperature between either 3000K/3500K/4000K or 2700/5000K. Minimum 80 CRI.
- **Thermal** - Die cast heat sink maximizes passive thermal management and achieves a L70 rated lifetime of 50,000 hours. Ambient temperature rated from -13°F to 95°F (-25°C to 35°C).
- **Compliance and Warranty** - ETL Classified and Listed for wet locations. Certified air-tight per ASTM 283-04. IC Rated for direct contact with insulation. Complies with FCC 47CFR Part 15B consumer limits for EMI/RFI emissions. 5 year parts warranty for complete fixture. Optional 10 Year Extended Warranty available, subject to same terms, conditions and installation requirements as standard 5 Year Warranty.



033021



## BENEFITS

- Field select lumen output
- Field select CCT
- Quick and easy installation
- 0-10V or 120V dimmable
- Long life time, L70 Rated for 50,000 hours

## APPLICATIONS

- Commercial
- Educational
- Retail
- Hospitality
- Outdoor Under Covered Ceilings

## ORDERING INFORMATION

Series	Size	CRI	CCT	Dimming
<input checked="" type="checkbox"/> SLFT SELECTFIT	<input checked="" type="checkbox"/> 8 8" 1,130 / 1,545 / 1,960lm	<input checked="" type="checkbox"/> 80 CRI 80	<input type="checkbox"/> CCTS Selectable CCT 3000 / 3500 / 4000K  <input type="checkbox"/> CCT2750* Selectable CCT 2700 / 5000K	<input type="checkbox"/> DIM120V 120V - Line voltage dimming  <input type="checkbox"/> DIM010UNV 120-277V - 0-10V dimming

\*Available in DIM010UNV only

## LINE DRAWINGS

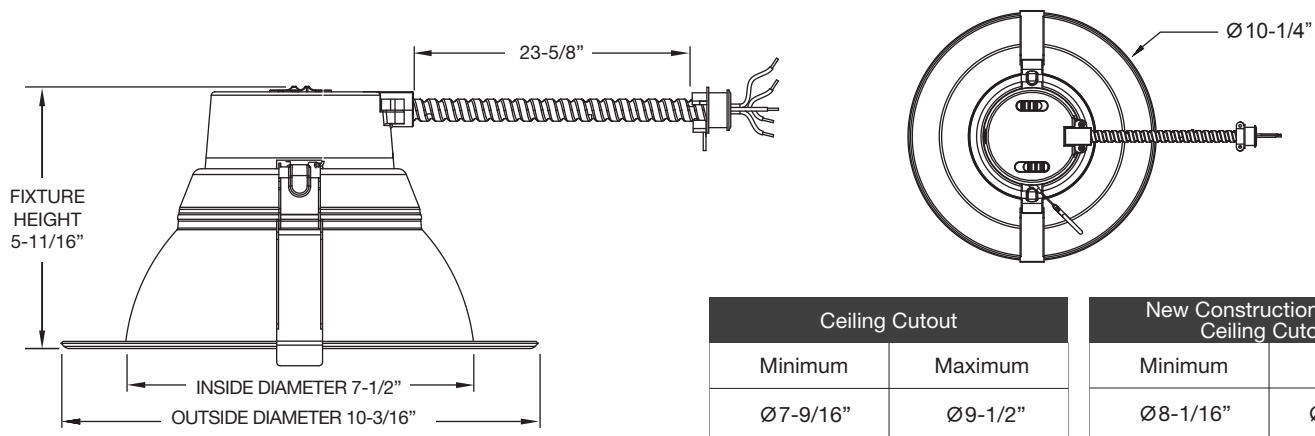



# SELECTFIT 8" RETROFIT DOWNLIGHT

TECHNICAL INFORMATION						
Dimming	Input Voltage	Input Frequency	Input Current	Input Power	THD Power	Power Factor
DIM120	120V	50 / 60Hz	0.10 / 0.13 / 0.17A	11 / 15 / 19W	<20%	>0.9
DIM010VUNV	120V	50 / 60Hz	0.10 / 0.12 / 0.16A	11 / 15 / 19W	<20%	>0.9
	277V		0.06 / 0.07 / 0.08A			

## PHOTOMETRY

SLFT8/80CCTS/DIM120V (3500K Selected, High)

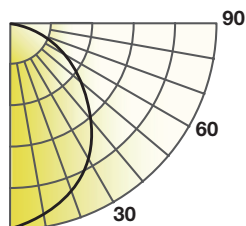

Lumens: 2201 lm  
 Power: 19 W  
 Efficacy: 114 lm/W  
 CRI: 80+  
 Spacing Criteria: 1.25  
 Beam Angle: 90°

Candlepower Distribution	
Angle (°)	Average (cd)
0	1097
5	1091
15	1042
25	943
35	775
45	549
55	303
65	114
75	58
85	13
90	0

Initial Footcandles		
Height (ft)	Fc	Diameter (ft)
8	17	16
9	14	18
10	11	20
12	8	24
15	5	30

Zonal Lumen Summary		
Zone	Lumens	%Fixt
0-30	830	38
0-40	1313	60
0-60	2007	91
0-90	2201	100

Lumen Output Coefficient			
CCT	3000K	3500K	4000K
Low Lumen output	0.53	0.56	0.54
Med Lumen output	0.73	0.76	0.74
High Lumen output	0.92	1.00	0.93

SLFT8/80CCT2750/DIM010UNV (5000K Selected, High)

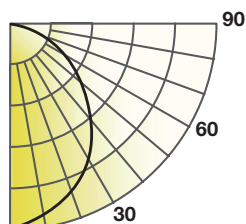

Lumens: 2017 lm  
 Power: 19 W  
 Efficacy: 108 lm/W  
 CRI: 80+  
 Spacing Criteria: 1.25  
 Beam Angle: 90°

Candlepower Distribution	
Angle (°)	Average (cd)
0	1005
5	1000
15	955
25	864
35	705
45	500
55	281
65	105
75	52
85	11
90	0

Initial Footcandles		
Height (ft)	Fc	Diameter (ft)
8	17	16
9	13	18
10	11	20
12	7	24
15	5	30

Zonal Lumen Summary		
Zone	Lumens	%Fixt
0-30	760	38
0-40	1200	60
0-60	1835	91
0-90	2017	100

Lumen Output Coefficient		
CCT	2700K	5000K
Low Lumen output	0.56	0.58
Med Lumen output	0.77	0.79
High Lumen output	0.97	1.00



# SELECTFIT 8" RETROFIT DOWNLIGHT

## PERFORMANCE

SLFT8/80CCTS/DIMxxx – LOW/MEDIUM/HIGH – 11 / 15 / 19W - NOMINAL*									
CCT	3000K			3500K			4000K		
Output	Low	Med	High	Low	Med	High	Low	Med	High
Lumens	1113	1533	1932	1176	1596	2100	1134	1554	1953
LPW	101	102	102	107	106	111	103	104	103

SLFT8/80CCT2750/DIMxxx – HIGH/MEDIUM/LOW – 11 / 15 / 19W - NOMINAL*						
CCT2750	2700K			5000K		
Output	Low	Med	High	Low	Med	High
Lumens	1125	1534	1939	1157	1578	2000
LPW	102	102	102	105	105	105

\*The above values are nominal only and may vary slightly depending on the dimming and voltage applied





## ACCESSORY ORDERING INFORMATION

Product	Model	Description	Pictures	Dimensions
35159	SLFT/TRIM8/CC	8" Clear Trim Insert (Field Installation)		
98567	GOOFRING8	8" Goof Ring - Outer Diameter 12-1/2"		
35123	NCFJB8	New Construction Frame for T-Grid ceilings and stud/joist mounting		
35126	NCFBFB	Field Installable Butterfly Brackets For New Construction Frame		
35125	NCFEMB	Field Installable Emergency Bracket For New Construction Frame		
98501	NCPLATE/T4689	New Construction Plate for T-Grid ceilings		
98502	NCPLATE468	New Construction Plate for Stud/Joist ceilings		

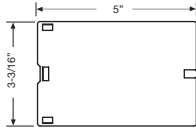

# SELECTFIT 8" RETROFIT DOWNLIGHT

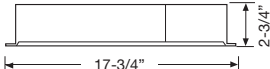
## ACCESSORY ORDERING INFORMATION

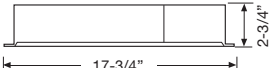
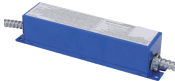
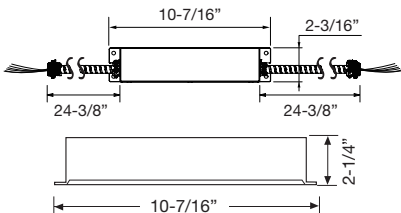
Product	Model	Description	Pictures	Dimensions
98583	NCPLATEJB	Junction box for New Construction Plates		
58012	35EMINVERTER	35W Emergency Inverter (Field Installation)		
58013	35EMINVERTER/CEC	California Title 20 Compliant 35W Emergency Inverter (Field Installation)		
98003	23EMDRIVER	California Title 20 Compliant 23W Emergency LED Driver (Field Installation)		

## ORDERING GUIDE

Product	Model
98545	SLFT8/80CCTS/DIM120V
98546	SLFT8/80CCTS/DIM010UNV
98547	SLFT8/80CCT2750/DIM010UNV

## 10 YEAR EXTENDED WARRANTY

Model	SLFT8/10YEARWARRANTY

Note: All rights reserved. All sizes and specifications are subject to change at any time without notice.