

Project Name:	Type:
Part Number:	Date:

SELECTFIT 9.5" RETROFIT DOWNLIGHT

SPECIFICATION FEATURES

- **Mechanical** - SELECTFIT, with integrated driver, retrofits existing commercial housings and is field accessible from below the ceiling. Stainless steel spring action clips accommodate 1/2" to 2" ceiling thicknesses.
- **Electrical** - Field select from three lumen outputs using SelectDrive technology. Universal 120-277V or 120V only, 50/60 Hz drivers available. Universal 0-10V drivers dimmable to 5% with low end cutoff. 120V drivers are dimmable to 10% using TRIAC or ELV dimmers.
- **Optical** - Self flanged spun aluminum reflector, painted matte white. Optional clear aluminum trim insert available. High resistance polycarbonate optical lens, with smooth diffusion. 90° beam angle. Field select color temperature between either 3000K/3500K/4000K or 2700/5000K. Minimum 80 CRI.
- **Thermal** - Die cast heat sink maximizes passive thermal management and achieves a L70 rated lifetime of 50,000 hours. Ambient temperature rated from -13°F to 95°F (-25°C to 35°C).
- **Compliance and Warranty** - ETL Classified and Listed for wet locations. Certified air-tight per ASTM 283-04. Complies with FCC 47CFR Part 15B consumer limits for EMI/RFI emissions. 5 year parts warranty for complete fixture. Optional 10 Year Extended Warranty available, subject to same terms, conditions and installation requirements as standard 5 Year Warranty.



033021



BENEFITS

- Field select lumen output
- Field select CCT
- Quick and easy installation
- 0-10V or 120V dimmable
- Long life time, L70 Rated for 50,000 hours

APPLICATIONS

- Commercial
- Educational
- Retail
- Hospitality
- Outdoor Under Covered Ceilings

ORDERING INFORMATION

Series	Size	CRI	CCT	Dimming
<input checked="" type="checkbox"/> SLFT SELECTFIT	<input checked="" type="checkbox"/> 9.5 9.5" 1,960 / 2,450 / 3,140lm	<input checked="" type="checkbox"/> 80 CRI 80	<input type="checkbox"/> CCTS Selectable CCT 3000 / 3500 / 4000K	<input type="checkbox"/> DIM120V 120V - Line voltage dimming
			<input type="checkbox"/> CCT2750* Selectable CCT 2700 / 5000K	<input type="checkbox"/> DIM010UNV 120-277V - 0-10V dimming

*Available in DIM010UNV only

LINE DRAWINGS

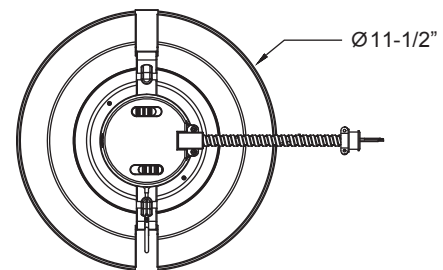
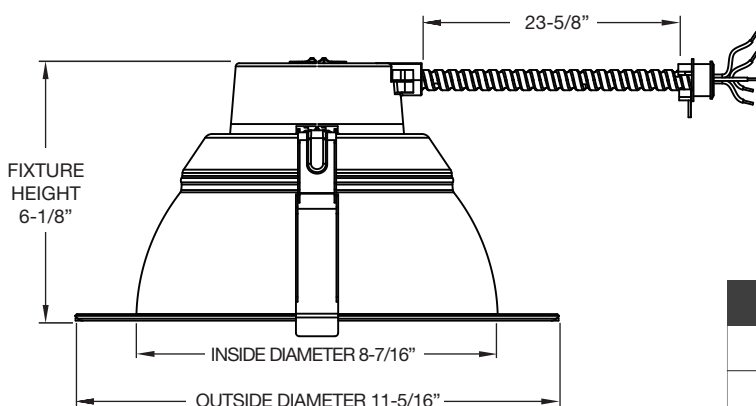

Ceiling Cutout		New Construction Frame Ceiling Cutout	
Minimum	Maximum	Minimum	Maximum
Ø8-1/2"	Ø10-11/16"	Ø9-3/4"	Ø10-1/2"



SELECTFIT 9.5" RETROFIT DOWNLIGHT

TECHNICAL INFORMATION						
Dimming	Input Voltage	Input Frequency	Input Current	Input Power	THD Power	Power Factor
DIM120	120V	50 / 60Hz	0.15 / 0.20 / 0.26 A	18 / 23 / 30W	<20%	>0.9
DIM010VUNV	120V	50 / 60Hz	0.15 / 0.19 / 0.25 A	18 / 23 / 30W	<20%	>0.9
	277V		0.08 / 0.09 / 0.11 A			

PHOTOMETRY

SLFT9.5/80CCTS/DIM120V (3500K Selected, High)

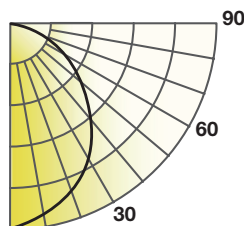

Lumens: 3390 lm
 Power: 29.5 W
 Efficacy: 115 lm/W
 CRI: 80+
 Spacing Criteria: 1.25
 Beam Angle: 91.2°

Candlepower Distribution	
Angle (°)	Average (cd)
0	1658
5	1650
15	1582
25	1438
35	1196
45	857
55	468
65	185
75	102
85	27
90	0

Initial Footcandles		
Height (ft)	Fc	Diameter (ft)
8	17	16
9	14	18
10	11	20
12	8	24
15	5	30

Zonal Lumen Summary		
Zone	Lumens	%Fixt
0-30	1263	37
0-40	2004	59
0-60	3071	91
0-90	3390	100

Lumen Output Coefficient			
CCT	3000K	3500K	4000K
Low Lumen output	0.55	0.59	0.94
Med Lumen output	0.72	0.75	1.00
High Lumen output	0.95	0.73	0.95

SLFT9.5/80CCT2750/DIM010UNV (5000K Selected, High)

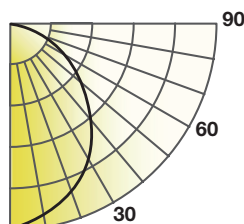

Lumens: 3166 lm
 Power: 29.5 W
 Efficacy: 108 lm/W
 CRI: 80+
 Spacing Criteria: 1.25
 Beam Angle: 91°

Candlepower Distribution	
Angle (°)	Average (cd)
0	1542
5	1536
15	1471
25	1342
35	1102
45	801
55	434
65	162
75	95
85	24
90	0

Initial Footcandles		
Height (ft)	Fc	Diameter (ft)
8	24	16
9	19	18
10	15	20
12	11	24
15	7	31

Zonal Lumen Summary		
Zone	Lumens	%Fixt
0-30	1175	37
0-40	1866	59
0-60	2862	90
0-90	3166	100

Lumen Output Coefficient		
CCT	2700K	5000K
Low Lumen output	0.60	0.61
Med Lumen output	0.76	0.78
High Lumen output	0.97	1.00



SELECTFIT 9.5" RETROFIT DOWNLIGHT







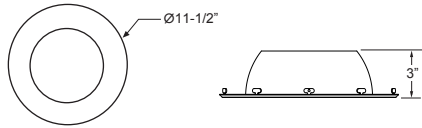

PERFORMANCE

SLFT9.5/80CCTS/DIMxxx – LOW/MEDIUM/HIGH – 18 / 23 / 30W - NOMINAL*									
CCT	3000K			3500K			4000K		
Output	Low	Med	High	Low	Med	High	Low	Med	High
Lumens	1815	2376	3102	1947	2475	3300	1848	2409	3135
LPW	101	103	103	108	108	110	103	105	105

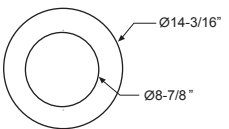
SLFT9.5/80CCT2750/DIMxxx – LOW/MEDIUM/HIGH – 18 / 23 / 30W - NOMINAL*						
CCT2750	2700K			5000K		
Output	Low	Med	High	Low	Med	High
Lumens	1890	2394	3056	1922	2457	3150
LPW	105	104	102	107	107	105

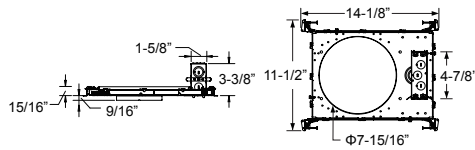
*The above values are nominal only and may vary slightly depending on the dimming and voltage applied

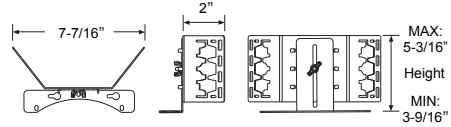

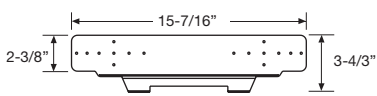
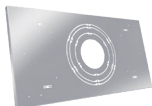
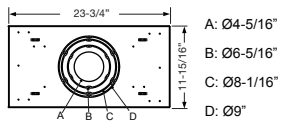



ACCESSORY ORDERING INFORMATION

Product	Model	Description	Pictures	Dimensions
35160	SLFT/TRIM9.5/CC	9.5" Clear Trim Insert (Field Installation)		
98566	GOOFRING9.5	9.5" Goof Ring - Outer Diameter 14-3/16"		
35124	NCFJB9.5	New Construction Frame for T-Grid ceilings and stud/joist mounting		
35126	NCFBFB	Field Installable Butterfly Brackets For New Construction Frame		
35125	NCFEMB	Field Installable Emergency Bracket For New Construction Frame		
98501	NCPLATE/T4689	New Construction Plate for T-Grid ceilings		

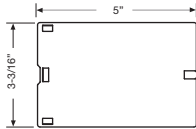

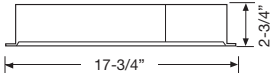
SELECTFIT 9.5" RETROFIT DOWNLIGHT

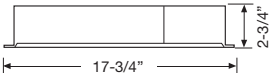
ACCESSORY ORDERING INFORMATION

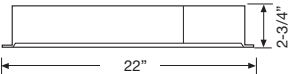
Product	Model	Description	Pictures	Dimensions
98583	NCPLATEJB	Junction box for New Construction Plates		
58012	35EMINVERTER	35W Emergency Inverter (Field Installation)		
58013	35EMINVERTER/CEC	California Title 20 Compliant 35W Emergency Inverter (Field Installation)		
98235	50EMINVERTER	Emergency Inverter 50W		

ORDERING GUIDE

Product	Model
98548	SLFT9.5/80CCTS/DIM120V
98549	SLFT9.5/80CCTS/DIM010UNV
98550	SLFT9.5/80CCT2750/DIM010UNV

10 YEAR EXTENDED WARRANTY

Model	SLFT9.5/10YEARWARRANTY

Note: All rights reserved. All sizes and specifications are subject to change at any time without notice.