

Project Name:	Type:
Part Number:	Date:



GREENCREATIVE

SPECFIT 8" NEW CONSTRUCTION

SPECIFICATION FEATURES

- **Mechanical** - Galvanized steel plaster frame. Low profile bar hangers with non-pass through construction and leveling flanges contain integral tee bar clip and preinstalled nail. Bar hangers are adjustable from 13-1/4" to 24-1/2" and can be installed in suspended T-Grid or wood joist ceilings. Attached junction box with quick connect MC cable allows for easy fixture wiring. The reflector's spring action clips allow for a secure installation in ceilings from 1/2" to 2" thick.
- **Electrical** - Two selectable lumen output driver options with SelectDrive technology. The 120V, 50/60 Hz driver is forward or reverse phase dimmable to 5%. The 120-277V, 50/60 Hz driver is 0-10V dimmable to 5% with a low end cutoff and comes with a 12V auxiliary port that provides power for field installed sensors and control modules. Static lumen output driver options include the Lutron 5-Series Ecosystem driver which provides smooth dimming to 5% and the Lutron Hi-Lume 1% EcoSystem driver with Soft-On, Fade-to-Black which dims to 1%. EldoLED ECOdrive and SOLOdrive drivers are available in 0-10V and DALi configurations and dim smoothly to 1% and 0.1% respectively. Enlighted compact sensors and Philips EasySense sensors are field installable and directly integrate with the factory provided Philips Xitanium driver and Sensor Ready Bridge.
- **Optical** - Self-flanged spun aluminum reflector. 45° optical cutoff. Field interchangeable optical lenses. Four beam distributions range from 25°- 75°. Wall wash field installed accessory. COB LED binned to 3-step SDCM to ensure color uniformity in 2700K, 3000K, 3500K, 4000K or 5000K CCT. Minimum 90 CRI. 97 CRI with TRUE CHROMA available in 3000K only.
- **Thermal** - Die cast heat sink. L70 lifetime of 100,000 hours. Fixture operating temperature: -13°F to +95°F (-25°C to 35°C).
- **Compliance and Warranty** - ETL Classified and Listed for damp locations. ETL Classified for WET location, under covered ceiling, when utilizing WET option with field installed gasketed ring. Suitable for exterior under canopy mounting when utilizing OUT Outdoor Debris Ingress Protection option. 5 year parts warranty for complete fixture. Optional 10 Year Extended Warranty available, subject to same terms, conditions and installation requirements as standard 5 Year Warranty.



111821



BENEFITS

- Get the right amount of light with SelectDrive technology
- Fits standard 2x2 & 2x4 T-Grids and up to 24" wood joist spacing
- Multiple reflector finish options facilitate any décor
- Field interchangeable optics ensure smooth light levels
- Large variety of dimming and sensor control options
- Exceptional color rendering and uniformity

APPLICATIONS

- Commercial Office
- Hospitality
- Retail
- Educational
- Healthcare
- Exterior Under Canopy*

*Applicable with OUT Outdoor Debris Ingress Protection option.

DIMENSIONS

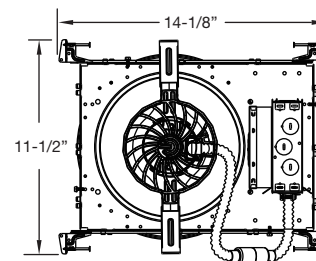
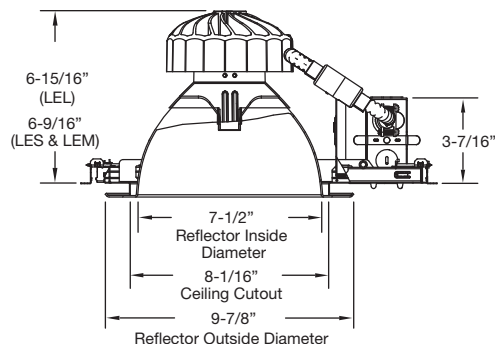



SPECFIT 8" NEW CONSTRUCTION

DIMENSIONS

with / Sensor

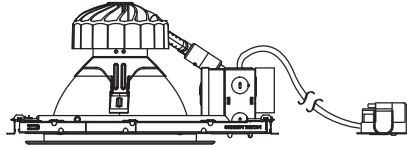

Philips EasySense sensor shown.
Enlighted compact sensor also available.

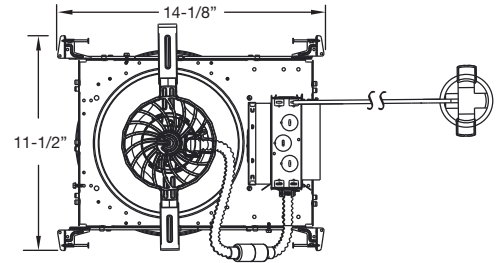

with / EM

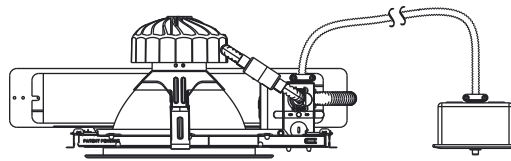

EM Test Switch shown.
Single gang j-box by others.

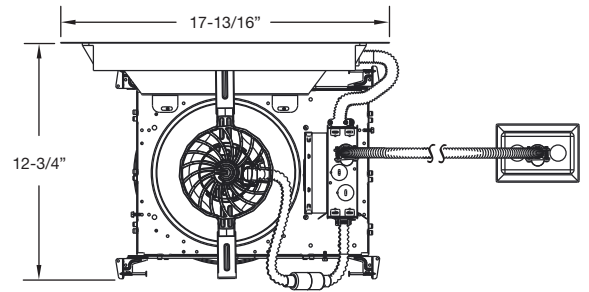

ORDERING EXAMPLE

A complete fixture consists of one light engine and one reflector.

SelectDrive Light Engine: SPFTR8/LEL9035/KDIM010UNV/MD/OUT/EM
Reflector: ADR8CC

SelectDrive Light Engines

Frame Housing	Light Engine	CRI	CCT	Driver	Optical Distribution	Options ⁷
<input type="checkbox"/> SPFTR8 SPECFIT Round New Construction 8"	<input type="checkbox"/> LES Small Light Engine 500-700-1000 lumens	<input type="checkbox"/> 90 90+ CRI	<input type="checkbox"/> 27 2700K	<input type="checkbox"/> KDIM120V SelectDrive 120V, 50/60Hz Forward/Reverse Phase dimming	<input type="checkbox"/> SP¹¹ Spot 15° Beam Angle	<input type="checkbox"/> SD347 347V - 240V Step Down Transformer
	<input type="checkbox"/> LEM Medium Light Engine 1500-2000-2500 lumens	<input type="checkbox"/> 97³ 97 CRI 3000K True Chroma	<input type="checkbox"/> 30 3000K	<input type="checkbox"/> KDIM010UNV² SelectDrive 120-277V, 50/60Hz 0-10V dimming	<input type="checkbox"/> MD¹ Medium (Installed Standard) 60° Beam angle	<input type="checkbox"/> EM⁴ 10W Pre-installed Emergency Backup
	<input type="checkbox"/> LEL Large Light Engine 3000-4000-5000 lumens		<input type="checkbox"/> 35 3500K		<input type="checkbox"/> VN Very Narrow 25° Beam angle	<input type="checkbox"/> EM⁴-CEC 10W Pre-installed Emergency Backup California Compliant
			<input type="checkbox"/> 40 4000K		<input type="checkbox"/> NR Narrow 40° Beam angle	<input type="checkbox"/> OUT Outdoor Debris Ingress Protection
			<input type="checkbox"/> 50 5000K		<input type="checkbox"/> WD Wide 75° Beam angle	<input type="checkbox"/> WET¹⁰ Field installable wet location gasketed ring

Reflectors

Shape	Finish
<input type="checkbox"/> ADR8 8" Round Reflector	<input type="checkbox"/> CC Clear Diffuse Trim and Flange <input type="checkbox"/> WH Matte White Trim and Flange
	<input type="checkbox"/> CW Clear Diffuse Trim, White Flange

¹ Medium Lens Optic comes installed as standard, if other optic distribution selected the lens will ship separately and require field installation. / ² Dims to 5% with low end cutoff. Dimmer compatibility available on website. / ³ CRI97 TRUE CHROMA is only available in 3000K only and is not Energy Star rated. It is made to order (MTO) for the lumen values of 3000 and above, including the LEL light engine. / ⁴ EM cannot be combined with SD347 or SD480 option / ⁷ Options are factory installed and come with the Light Engine and Driver. / ¹⁰ Wet location makes the downlight ETL certified for WET location installation, separate gasketed ring will be provided with the light engine for field installation. / ¹¹ SP optic is not available with LEL model.



SPECFIT 8" NEW CONSTRUCTION

ORDERING EXAMPLE

A complete fixture consists of one light engine and one reflector.

Philips Light Engine W/ Enlighted Micro Sensor: SPFTR8/LE25/9040/PSRUNV/VN/ENLS-IOT Reflector: ADR8CC	Lutron EcoSystem Light Engine: SPFTR8/LE15/9027/LUT-5UNV/NR Reflector: ADR8BL
Philips Light Engine W/ EasySense Sensor: SPFTR8/LE50/9030/PSRUNV/VN/ES Reflector: ADR8CW	EldoLED Light Engine SOLOdrive: SPFTR8/LE20/9035/ELD-S010UNV/WD Reflector: ADR8WH

ORDERING INFORMATION

Fixed Output Light Engines

Frame Housing	Light Engine	CRI	CCT	Driver	Optical Distribution	Options ⁷
<input type="checkbox"/> SPFTR8 SPECFIT Round New Construction 8"	<input type="checkbox"/> LE05⁸ 500 lumens	<input type="checkbox"/> 90 90+CRI	<input type="checkbox"/> 27 2700K	<input type="checkbox"/> PSRUNV Signify 0-10V Driver + Sensor Ready Bridge, 1% Dimming, 120-277V	<input type="checkbox"/> SP¹¹ Spot 15° Beam Angle	<input type="checkbox"/> SD347 347V - 240V Step Down Transformer
	<input type="checkbox"/> LE07 700 lumens	<input type="checkbox"/> 97³ 97 CRI 3000K True Chroma	<input type="checkbox"/> 30 3000K	<input type="checkbox"/> XT010UNV Signify 0-10V Driver 1% Dimming, 120-277V	<input type="checkbox"/> MD¹ Medium (Installed Standard) 60° Beam angle	<input type="checkbox"/> EM⁴ 10.7W Emergency Backup
	<input type="checkbox"/> LE10 1,000 lumens		<input type="checkbox"/> 35 3500K	<input type="checkbox"/> LUT-1UNV Lutron EcoSystem 1% Dimming, 120-277V	<input type="checkbox"/> VN Very Narrow 25° Beam angle	<input type="checkbox"/> EM⁴-CEC California Title 20 Compliant 10.7W Emergency Backup
	<input type="checkbox"/> LE15 1,500 lumens		<input type="checkbox"/> 40 4000K	<input type="checkbox"/> LUT-5UNV Lutron EcoSystem 5% Dimming, 120-277V	<input type="checkbox"/> NR Narrow 40° Beam angle	<input type="checkbox"/> ES⁵ Philips EasySense ceiling mount sensor
	<input type="checkbox"/> LE20 2,000 lumens		<input type="checkbox"/> 50 5000K	<input type="checkbox"/> LUT-L3DUNV Lutron Hi-Lume 3-Wire 1% Dimming, 120-277V	<input type="checkbox"/> WD Wide 75° Beam angle	<input type="checkbox"/> ENLS⁶-IL Enlighted Two Wire ENLIGHTED ONE Compact Sensor
	<input type="checkbox"/> LE25 2,500 lumens			<input type="checkbox"/> ELD-E010UNV EldoLED ECOdrive 0-10V 1%, 120-277V		<input type="checkbox"/> ENLS⁶-CL Enlighted Two Wire CONNECTED LIGHTING Compact Sensor
	<input type="checkbox"/> LE30 3,000 lumens			<input type="checkbox"/> ELD-EDALIUNV EldoLED ECOdrive DALI 1%, 120-277V		<input type="checkbox"/> ENLS⁶-IOT Enlighted Two Wire IOT Compact Sensor
	<input type="checkbox"/> LE40 4,000 lumens			<input type="checkbox"/> ELD-S010UNV EldoLED SOLOdrive 0-10V 0.1%, 120-277V		<input type="checkbox"/> OUT Outdoor Debris Ingress Protection
	<input type="checkbox"/> LE50⁹ 5,000 lumens			<input type="checkbox"/> ELD-SDALIUNV EldoLED SOLOdrive DALI 0.1%, 120-277V		<input type="checkbox"/> WET¹⁰ Field installable wet location gasketed ring

Reflectors

Shape	Finish
<input type="checkbox"/> ADR8 8" Round Reflector	<input type="checkbox"/> CC Clear Diffuse Trim and Flange
	<input type="checkbox"/> WH Matte White Trim and Flange
	<input type="checkbox"/> CW Clear Diffuse Trim, White Flange

¹ Medium Lens Optic comes installed as standard, if other optic distribution selected the lens will ship separately and require field installation / ³ CRI97 TRUE CHROMA is only available in 3000K only and is not Energy Star rated. It is made to order (MTO) for the lumen values of 3000 and above, including the LEL light engine. / ⁴ EM cannot be combined with SD347 or SD480 option / ⁵ Philips EasySense ceiling mounted sensor is only available with the PSRUNV driver / ⁶ Enlighted Two Wire Compact Sensor with ceiling mount is only available with the PSRUNV driver. / ⁷ Options are factory installed and come with the Light Engine and Driver. / ⁸ LE05 is not available with LUT-5UNV / ⁹ LE50 is not available with LUT-5UNV and LUT-1UNV. / ¹⁰ Wet location makes the downlight ETL certified for WET location installation, separate gasketed ring will be provided with the light engine for field installation. / ¹¹ SP optic is not available with LEL model.



SPECFIT 8" NEW CONSTRUCTION

ACCESSORY ORDERING INFORMATION				
Product	Model	Description	Pictures	Dimensions
98079	ADWAW	Wall Wash (Field Installed on Lens)		
35126	NCFBFB	Set of Two Field Installable Butterfly Brackets For New Construction Rough-in Frame		
35125	NCFEMB	Field Installable Emergency Bracket For New Construction Rough-in Frame		

10 YEAR EXTENDED WARRANTY	
Model	SPFTR8 / LE _{xx} / 10YEARWARRANTY*
<p>*Where xx = Fixture Light Engine lumen output designation. Example: 10 Year Warranty Part Number for SPFTR8/LEM or SPFTR8/LE20 Light engine is SPFTR8/LEM/10YEARWARRANTY and SPFTR8/LE20/10YEARWARRANTY respectively.</p>	



SPECFIT 8" NEW CONSTRUCTION

TECHNICAL INFORMATION

Light Engine	Input Voltage	Input Frequency	Input Current	Input Power	THD Power	Power Factor
LESXXXX	120 / 277V	50 / 60Hz	0.115 / 0.047A	13W	<20%	>0.9
LEMXXXX	120 / 277V	50 / 60Hz	0.270 / 0.114A	31.5W	<20%	>0.9
LELXXXX	120 / 277V	50 / 60Hz	0.530 / 0.217A	60W	<20%	>0.9
LE05XXXX	120 / 277V	50 / 60Hz	0.056 / 0.024A	6.5W	<20%	>0.9
LE07XXXX	120 / 277V	50 / 60Hz	0.073 / 0.034A	8.5W	<20%	>0.9
LE10XXXX	120 / 277V	50 / 60Hz	0.112 / 0.047A	13W	<20%	>0.9
LE15XXXX	120 / 277V	50 / 60Hz	0.154 / 0.068A	18W	<20%	>0.9
LE20XXXX	120 / 277V	50 / 60Hz	0.218 / 0.092A	25.5W	<20%	>0.9
LE25XXXX	120 / 277V	50 / 60Hz	0.269 / 0.116A	31.5W	<20%	>0.9
LE30XXXX	120 / 277V	50 / 60Hz	0.318 / 0.133A	37.5W	<20%	>0.9
LE40XXXX	120 / 277V	50 / 60Hz	0.411 / 0.165A	48.5W	<20%	>0.9
LE50XXXX	120 / 277V	50 / 60Hz	0.487 / 0.203A	57.5W	<20%	>0.9

NOMINAL PERFORMANCE

LES (LE05 / LE07 / LE10) - Low / Medium / High - 6.5 / 8.5 / 13W

CCT	2700K			3000K			3500K			4000K			5000K		
	Low	Medium	High	Low	Medium	High	Low	Medium	High	Low	Medium	High	Low	Medium	High
Output**	Im LPW	Im LPW	Im LPW	Im LPW	Im LPW	Im LPW	Im LPW	Im LPW	Im LPW	Im LPW	Im LPW	Im LPW	Im LPW	Im LPW	Im LPW
Finish	Im LPW	Im LPW	Im LPW	Im LPW	Im LPW	Im LPW	Im LPW	Im LPW	Im LPW	Im LPW	Im LPW	Im LPW	Im LPW	Im LPW	Im LPW
Clear Diffuse	500 77	700 82	1,000 80	525 81	735 86	1,050 84	550 85	770 91	1,100 88	575 88	805 95	1,150 92	580 89	810 95	1,165 93
White	495 76	693 82	990 79	520 80	728 86	1,040 83	545 84	762 90	1,089 87	569 88	797 94	1,139 91	574 88	802 94	1,153 92
Black	440 68	616 72	880 70	462 71	647 76	924 74	484 74	678 80	968 77	506 78	708 83	1,012 81	510 78	714 84	1,015 81

LEM (LE15 / LE20 / LE25) - Low / Medium / High - 18.0 / 25.5 / 31.5W

CCT	2700K			3000K			3500K			4000K			5000K		
	Low	Medium	High	Low	Medium	High	Low	Medium	High	Low	Medium	High	Low	Medium	High
Output**	Im LPW	Im LPW	Im LPW	Im LPW	Im LPW	Im LPW	Im LPW	Im LPW	Im LPW	Im LPW	Im LPW	Im LPW	Im LPW	Im LPW	Im LPW
Finish	Im LPW	Im LPW	Im LPW	Im LPW	Im LPW	Im LPW	Im LPW	Im LPW	Im LPW	Im LPW	Im LPW	Im LPW	Im LPW	Im LPW	Im LPW
Clear Diffuse	1,600 89	2,125 83	2,500 79	1,632 91	2,169 85	2,550 81	1,664 92	2,210 87	2,600 83	1,696 94	2,253 88	2,650 84	1,713 95	2,275 89	2,677 85
White	1,584 88	2,104 82	2,475 78	1,616 90	2,147 84	2,525 80	1,647 91	2,188 86	2,574 82	1,679 93	2,230 87	2,624 83	1,696 94	2,252 88	2,650 84
Black	1,408 78	1,870 73	2,200 70	1,436 80	1,909 75	2,244 71	1,464 81	1,945 77	2,288 73	1,492 83	1,983 77	2,332 74	1,507 84	2,002 79	2,355 75

LEL (LE30 / LE40 / LE50) - Low / Medium / High - 37.5 / 48.5 / 60.0W

CCT	2700K			3000K			3500K			4000K			5000K		
	Low	Medium	High	Low	Medium	High	Low	Medium	High	Low	Medium	High	Low	Medium	High
Output**	Im LPW	Im LPW	Im LPW	Im LPW	Im LPW	Im LPW	Im LPW	Im LPW	Im LPW	Im LPW	Im LPW	Im LPW	Im LPW	Im LPW	Im LPW
Finish	Im LPW	Im LPW	Im LPW	Im LPW	Im LPW	Im LPW	Im LPW	Im LPW	Im LPW	Im LPW	Im LPW	Im LPW	Im LPW	Im LPW	Im LPW
Clear Diffuse	3,325 89	4,085 84	4,750 79	3,360 90	4,080 84	4,800 80	3,500 93	4,250 88	5,000 83	3,640 97	4,420 91	5,200 87	3,640 97	4,420 91	5,200 87
White	3,292 88	4,044 83	4,703 78	3,326 89	4,039 83	4,752 79	3,465 92	4,208 87	4,950 82	3,604 96	4,376 90	5,148 86	3,604 96	4,376 90	5,148 86
Black	2,826 78	3,472 71	4,038 67	2,856 77	3,468 71	4,080 68	2,975 79	3,613 75	4,250 71	3,094 82	3,757 77	4,420 74	2,829 75	3,757 77	4,420 74

** Lumen output are based on rated lumens, for exact value please refer to the IES files



SPECFIT 8" NEW CONSTRUCTION

PHOTOMETRY

SPFTR8-LES9035-KDIM010-UNV-VN-ADR8CC

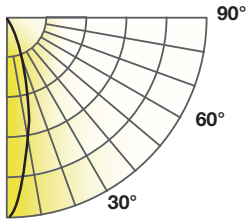

Lumens: 1,239 lm
Power: 12.49 W
Efficacy: 99.23 lm/W
CRI: 90+
Spacing Criteria: 0.42
Beam Angle: 25.7°

Candlepower Distribution		Initial Footcandles			Zonal Lumen Summary		
Angle (°)	Average (cd)	Height (ft)	Fc	Diameter (ft)	Zone	Lumens	%Fixt
10	2,617	4	276	1.8	0-30	1,135	92%
20	1,156	6	123	2.7	0-40	1,223	99%
30	322	8	69	3.6	0-60	1,238	100%
40	32	10	44	4.5	0-90	1,239	100%
50	3	12	31	5.5			
60	1						
70	0						
80	0						
90	0						

SPFTR8-LES9035-KDIM010-UNV-NR-ADR8CC

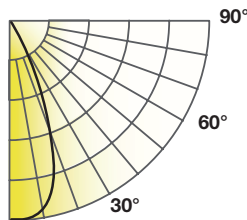

Lumens: 1,233 lm
Power: 12.2 W
Efficacy: 101 lm/W
CRI: 90+
Spacing Criteria: 0.6
Beam Angle: 44°

Candlepower Distribution		Initial Footcandles			Zonal Lumen Summary		
Angle (°)	Average (cd)	Height (ft)	Fc	Diameter (ft)	Zone	Lumens	%Fixt
10	2,250	4	140	3.1	0-30	1,103	89%
20	1,464	6	62	4.7	0-40	1,220	99%
30	472	8	35	6.2	0-60	1,232	100%
40	45	10	22	7.8	0-90	1,233	100%
50	3	12	16	9.3			
60	1						
70	0						
80	0						
90	0						

SPFTR8-LES9035-KDIM010-UNV-MD-ADR8CC

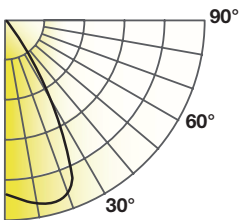

Lumens: 1,240 lm
Power: 12.4 W
Efficacy: 100 lm/W
CRI: 90+
Spacing Criteria: 0.9
Beam Angle: 63°

Candlepower Distribution		Initial Footcandles			Zonal Lumen Summary		
Angle (°)	Average (cd)	Height (ft)	Fc	Diameter (ft)	Zone	Lumens	%Fixt
10	2,250	8	82	4.2	0-30	1,103	89%
20	1,464	10	36	6.3	0-40	1,220	99%
30	472	12	20	8.4	0-60	1,232	100%
40	45	15	13	10.4	0-90	1,240	100%
50	3	20	9	12.5			
60	1						
70	0						
80	0						
90	0						

SPECFIT 8" NEW CONSTRUCTION

PHOTOMETRY

SPFTR8-LES9035-KDIM010-UNV-WD-ADR8CC

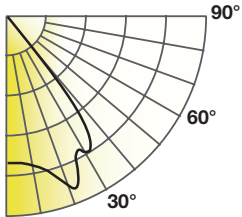

Lumens: 1,260 lm
 Power: 12.3 W
 Efficacy: 102 lm/W
 CRI: 90+
 Spacing Criteria: 1.2
 Beam Angle: 63°

Candlepower Distribution		Initial Footcandles			Zonal Lumen Summary		
Angle (°)	Average (cd)	Height (ft)	Fc	Diameter (ft)	Zone	Lumens	%Fixt
10	759	4	59	6.0	0-30	681	54%
20	739	6	26	9.0	0-40	1,153	92%
30	936	8	15	12.1	0-60	1,257	100%
40	477	10	9	15.1	0-90	1,260	100%
50	10	12	7	18.1			
60	3						
70	1						
80	0						
90	0						

SPFTR8-LEM9035-KDIM010-UNV-VN-ADR8CC

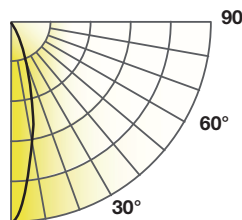

Lumens: 2,566 lm
 Power: 30.9 W
 Efficacy: 83 lm/W
 CRI: 90+
 Spacing Criteria: 0.4
 Beam Angle: 25°

Candlepower Distribution		Initial Footcandles			Zonal Lumen Summary		
Angle (°)	Average (cd)	Height (ft)	Fc	Diameter (ft)	Zone	Lumens	%Fixt
10	5,592	4	601	1.7	0-30	2357	92%
20	2178	6	267	2.6	0-40	2533	99%
30	635	8	150	3.4	0-60	2562	100%
40	88	10	96	4.3	0-90	2566	100%
50	12	12	67	5.2			
60	4						
70	1						
80	0						
90	0						

SPFTR8-LEM9035-KDIM010-UNV-NR-ADR8CC

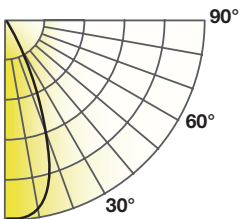

Lumens: 2,582 lm
 Power: 30.9 W
 Efficacy: 83 lm/W
 CRI: 90+
 Spacing Criteria: 0.665
 Beam Angle: 42°

Candlepower Distribution		Initial Footcandles			Zonal Lumen Summary		
Angle (°)	Average (cd)	Height (ft)	Fc	Diameter (ft)	Zone	Lumens	%Fixt
10	5,087	8	305	2.9	0-30	2,326	90%
20	2,558	10	136	4.3	0-40	2,554	99%
30	921	12	76	5.8	0-60	2,577	100%
40	86	15	49	7.2	0-90	2,582	100%
50	7	20	34	8.7			
60	2						
70	1						
80	0						
90	0						



SPECFIT 8" NEW CONSTRUCTION

PHOTOMETRY

SPFTR8-LEM9035-KDIM010-UNV-MD-ADR8CC

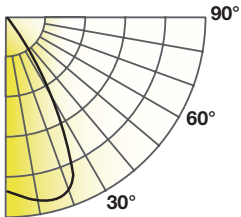

Lumens: 2548 lm
Power: 31.3 W
Efficacy: 81 lm/W
CRI: 90+
Spacing Criteria: 0.9
Beam Angle: 63°

Candlepower Distribution	
Angle (°)	Average (cd)
10	2,648
20	2,601
30	1,307
40	343
50	10
60	3
70	1
80	0
90	0

Initial Footcandles		
Height (ft)	Fc	Diameter (ft)
4	167	3.7
6	74	5.5
8	42	7.3
10	27	9.1
12	19	11.0

Zonal Lumen Summary		
Zone	Lumens	%Fixt
0-30	2,024	79%
0-40	2,487	98%
0-60	2,543	100%
0-90	2,548	100%

SPFTR8-LEM9035-KDIM010-UNV-WD-ADR8CC

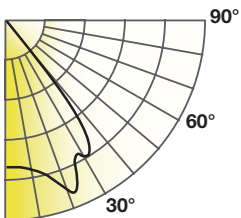

Lumens: 2567 lm
Power: 31.3 W
Efficacy: 82 lm/W
CRI: 90+
Spacing Criteria: 1.2
Beam Angle: 82°

Candlepower Distribution	
Angle (°)	Average (cd)
10	1,524
20	1,416
30	2,054
40	1,056
50	29
60	9
70	4
80	1
90	0

Initial Footcandles		
Height (ft)	Fc	Diameter (ft)
4	118	6.4
6	53	9.7
8	30	13.0
10	19	16.2
12	13	19.4

Zonal Lumen Summary		
Zone	Lumens	%Fixt
0-30	1,308	51%
0-40	2,312	90%
0-60	2,558	100%
0-90	2,567	100%

SPFTR8-LEL9035-KDIM010-UNV-VN-ADR8CC

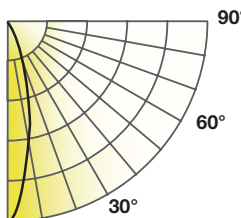

Lumens: 4767 lm
Power: 60.8 W
Efficacy: 78 lm/W
CRI: 90+
Spacing Criteria: 0.5
Beam Angle: 32°

Candlepower Distribution	
Angle (°)	Average (cd)
10	793
20	465
30	238
40	21
50	3
60	1
70	0
80	0
90	0

Initial Footcandles		
Height (ft)	Fc	Diameter (ft)
4	175	4.6
6	112	5.8
8	78	6.9
10	50	8.7
12	28	11.5

Zonal Lumen Summary		
Zone	Lumens	%Fixt
0-30	4,068	85%
0-40	4,612	91%
0-60	5,038	99%
0-90	4,767	100%



SPECFIT 8" NEW CONSTRUCTION

PHOTOMETRY

SPFTR8-LEL9035-KDIM010-UNV-NR-ADR8CC

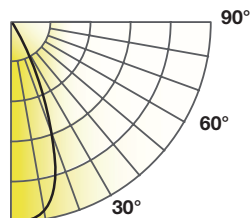

Lumens: 4885 lm
Power: 60.4 W
Efficacy: 81 lm/W
CRI: 90+
Spacing Criteria: 0.7
Beam Angle: 44°

Candlepower Distribution		Initial Footcandles			Zonal Lumen Summary		
Angle (°)	Average (cd)	Height (ft)	Fc	Diameter (ft)	Zone	Lumens	%Fixt
10	7,456	8	145	6.4	0-30	4,068	85%
20	5,085	10	93	8.0	0-40	4,666	98%
30	2,031	12	64	9.6	0-60	4,751	100%
40	202	15	41	12.0	0-90	4,885	100%
50	19	20	23	15.9			
60	7						
70	3						
80	1						
90	0						

SPFTR8-LEL9035-KDIM010-UNV-MD-ADR8CC

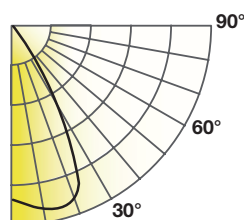

Lumens: 5041 lm
Power: 60.4 W
Efficacy: 83 lm/W
CRI: 90+
Spacing Criteria: 0.8
Beam Angle: 52°

Candlepower Distribution		Initial Footcandles			Zonal Lumen Summary		
Angle (°)	Average (cd)	Height (ft)	Fc	Diameter (ft)	Zone	Lumens	%Fixt
10	6,036	4	109	7.7	0-30	3,698	73%
20	4,389	6	70	9.6	0-40	4,897	97%
30	3,080	8	48	11.5	0-60	5,028	100%
40	891	10	31	14.4	0-90	5,041	100%
50	23	12	17	19.2			
60	8						
70	3						
80	1						
90	0						

SPFTR8-LEL9035-KDIM010-UNV-WD-ADR8CC

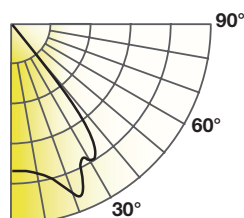

Lumens: 5064 lm
Power: 60.8 W
Efficacy: 83 lm/W
CRI: 90+
Spacing Criteria: 1.1
Beam Angle: 72°

Candlepower Distribution		Initial Footcandles			Zonal Lumen Summary		
Angle (°)	Average (cd)	Height (ft)	Fc	Diameter (ft)	Zone	Lumens	%Fixt
10	3,951	8	69	11.7	0-30	3,151	62%
20	3,789	10	44	14.6	0-40	4,680	92%
30	3,288	12	31	17.5	0-60	5,042	100%
40	1,604	15	20	21.9	0-90	5,064	100%
50	55	20	11	29.2			
60	18						
70	8						
80	3						
90	0						



SPECFIT 8" NEW CONSTRUCTION

PHOTOMETRY

SPFTR8-LES9730-KDIM010-UNV-MD-ADR8CC

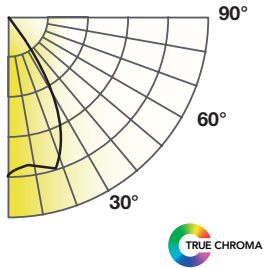

Lumens: 1,048 lm
 Power: 13 W
 Efficacy: 84 lm/W
 CRI: 96
 Spacing Criteria: 1.02
 Beam Angle: 65°

Candlepower Distribution	
Angle (°)	Average (cd)
10	977
20	972
30	615
40	190
50	3
60	0
70	0
80	0
90	0

Initial Footcandles		
Height (ft)	Fc	Diameter (ft)
4	91	5.1
6	40	7.6
8	23	10.2
10	15	12.7
12	10	15.3

Zonal Lumen Summary		
Zone	Lumens	%Fixt
0-30	744	71%
0-40	1,001	96%
0-60	1,047	100%
0-90	1,048	100%

SPFTR8-LEM9730-KDIM010-UNV-MD-ADR8CC

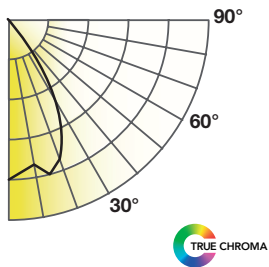

Lumens: 2,211 lm
 Power: 33 W
 Efficacy: 68 lm/W
 CRI: 96
 Spacing Criteria: 1.02
 Beam Angle: 65°

Candlepower Distribution	
Angle (°)	Average (cd)
10	2,032
20	2,035
30	1,287
40	375
50	7
60	2
70	0
80	0
90	0

Initial Footcandles		
Height (ft)	Fc	Diameter (ft)
4	189	5.1
6	84	7.7
8	47	10.3
10	30	12.8
12	21	15.4

Zonal Lumen Summary		
Zone	Lumens	%Fixt
0-30	1,568	71%
0-40	2,113	96%
0-60	2,209	100%
0-90	2,211	100%

SPFTR8-LEL9035-KDIM010-UNV-WD-ADR8CC

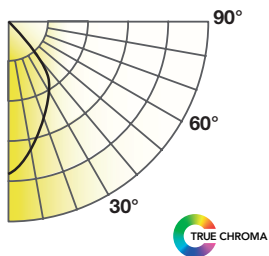

Lumens: 4,207 lm
 Power: 60 W
 Efficacy: 71 lm/W
 CRI: 96
 Spacing Criteria: 0.75
 Beam Angle: 54°

Candlepower Distribution	
Angle (°)	Average (cd)
10	4,536
20	3,392
30	2,396
40	903
50	7
60	0
70	0
80	0
90	0

Initial Footcandles		
Height (ft)	Fc	Diameter (ft)
8	47	8.1
10	30	10.1
12	21	12.1
15	13	15.2
20	8	20.2

Zonal Lumen Summary		
Zone	Lumens	%Fixt
0-30	2,901	69%
0-40	4,005	95%
0-60	4,207	100%
0-90	4,207	100%