

Project Name:	Type:
Part Number:	Date:

SPECFIT 4" SQUARE

SPECIFICATION FEATURES

- **Mechanical** - SPECFIT retrofits existing commercial housings. Spring action clips to accommodate 1/2" to 2" ceiling thicknesses. Fixture with remote driver installs and is accessible from below the ceiling.
- **Electrical** - Standard driver option is 120-277V, 50/60 Hz with three selectable lumen outputs using SelectDrive technology. 0-10V dimmable to 5% with low end cutoff. 12V auxiliary port with stand by power functionality for additional dimming and control of field installed sensors and control systems. Additional driver selections include a 120V line voltage dimming option, Lutron Ecosystem 5% and 1% dimming driver options and a Philips EasySense sensor compatible driver option.
- **Optical** - Self-flanged plated polycarbonate reflector. 40° optical cutoff. Field interchangeable optical lenses. Five beam distributions range from 15° to 75°. Wall wash field installed accessory. COB LED binned to 3-step SDCM to ensure color uniformity in 2700K, 3000K, 3500K, 4000K or 5000K CCT. Minimum 90 CRI. 97 CRI with TRUE CHROMA available in 3000K only.
- **Thermal** - Die cast heat sink. L70 lifetime of 100,000 hours. Fixture operating temperature: -13°F to +95°F (-25°C to 35°C).
- **Compliance and Warranty** - ETL Classified and Listed for damp locations. 5 year parts warranty for complete fixture.



050722



BENEFITS

- Get the right amount of light with SelectDrive technology
- Match ceiling décor with field interchangeable trims
- Direct the light with field interchangeable optics
- Various dimming driver options allow for control and energy savings
- Long 100,000 hours L70 rated lifetime

APPLICATIONS

- Commercial Office
- Hospitality
- Retail
- Educational
- Healthcare

DIMENSIONS

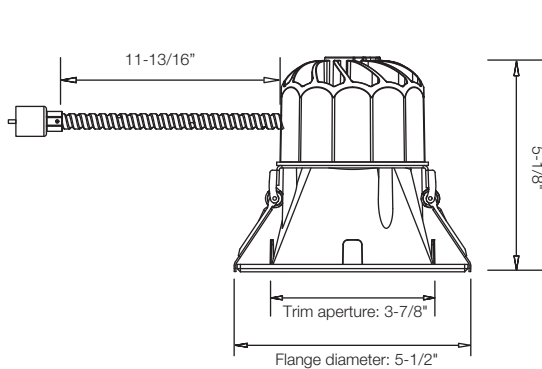

Compatible with most standard housing with aperture ranging from 4-1/8" - 5-5/16"

DIM010UNV or Fixed Output Driver

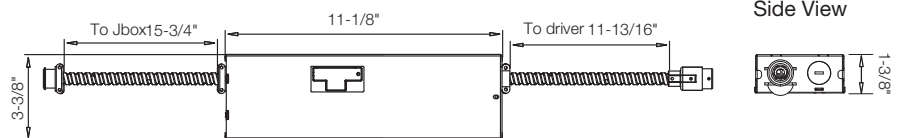

KDIM010UNV & KDIM120V

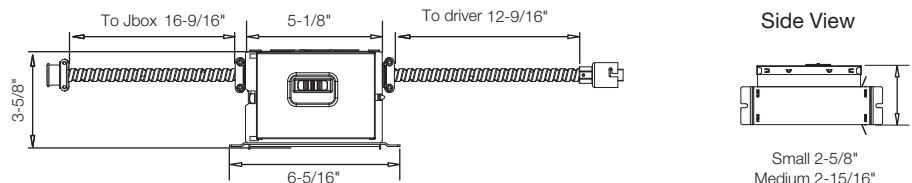



SPECFIT 4" SQUARE

ORDERING EXAMPLE

A complete fixture consists of one light engine and one reflector.

SelectDrive Light Engine: LEM9040DIM010UNVMD
Reflector: ADS4CC

SelectDrive Light Engines

Light Engine	CRI	CCT	Driver	Optical Distribution	Options ⁷
<input type="checkbox"/> LES Small Light Engine 500-700-1,000 lumens	<input type="checkbox"/> 90 90+CRI	<input type="checkbox"/> 27 2700K	<input type="checkbox"/> DIM010UNV² SelectDrive 120-277V, 50/60Hz 0-10V Dimmable to 5%	<input type="checkbox"/> SP¹⁰ Spot 15° Beam Angle	<input type="checkbox"/> SD347 347V - 240V Step Down Transformer
<input type="checkbox"/> LEM Medium Light Engine 1,500-2,000-2,500 lumens	<input type="checkbox"/> 97³ 97 CRI 3000K only	<input type="checkbox"/> 30 3000K	<input type="checkbox"/> KDIM010UNV¹¹ K-case Driver, SelectDrive 120-277V, 50/60Hz. Dimmable to 5%.	<input type="checkbox"/> MD¹ Medium (Installed Standard) 60° Beam angle	<input type="checkbox"/> SD480 480V - 240V Step Down Transformer
		<input type="checkbox"/> 35 3500K	<input type="checkbox"/> KDIM120V SelectDrive 120V, 50/60Hz Forward/Reverse Phase dimming. Dimmable to 5%.	<input type="checkbox"/> VN Very Narrow 25° Beam angle	<input type="checkbox"/> EM⁴ 10.7W Emergency Backup
		<input type="checkbox"/> 40 4000K		<input type="checkbox"/> NR Narrow 40° Beam angle	<input type="checkbox"/> EM⁴ -CEC California Title 20 Compliant 10.7W Emergency Backup
		<input type="checkbox"/> 50 5000K		<input type="checkbox"/> WD Wide 75° Beam angle	<input type="checkbox"/> OUT Outdoor Debris Ingress Protection
					<input type="checkbox"/> WET⁹ Field installable wet location gasketed ring

Reflectors

Shape	Finish
<input type="checkbox"/> ADS4 4" Square Reflector	<input type="checkbox"/> CC Clear Diffuse Trim and Flange <input type="checkbox"/> WH Matte White Trim and Flange

¹ Medium Lens Optic comes installed as standard, if other optic distribution selected the lens will ship separately and require field installation. / ² Dims to 5% with low end cutoff. Dimmer compatibility available on website. / ³ CRI97 TRUE CHROMA is only available in 3000K only and is not Energy Star rated. / ⁴ EM cannot be combined with SD347 or SD480 option. / ⁷ Options are factory installed and come with the Light Engine and Driver. / ⁹ Wet location makes the downlight ETL certified for WET location installation, separate gasketed ring will be provided with the light engine for field installation. / ¹⁰ SP optic is not available with LEL model. / ¹¹ Upgraded & compact new Light Engine with K-case driver will be available per CCT and Size once current generation is depleted. Please consult below ordering guide for availability. GREEN CREATIVE reserve the right to make change without notice.



SPECFIT 4" SQUARE

ORDERING EXAMPLE

A complete fixture consists of one light engine and one reflector.

Philips Light Engine W/ Enlighted Micro Sensor: Reflector:	LE259040PSRUNVWNENLS-IOT ADS4CC	Philips Light Engine W/ EasySense Sensor: Reflector:	LE059030PSRUNVWNES ADS4WH
120V Light Engine: Reflector:	LE209035DIM120VWD ADS4CC	Lutron EcoSystem Light Engine: Reflector:	LE159027LUT5UNVNR ADS4WH

ORDERING INFORMATION

Fixed Output Light Engines

Light Engine	CRI	CCT	Driver	Optical Distribution	Options ⁷
<input type="checkbox"/> LE05⁸ 500 lumens	<input type="checkbox"/> 90 90+CRI	<input type="checkbox"/> 27 2700K	<input type="checkbox"/> DIM120V 120V Dimmable, 120V	<input type="checkbox"/> MD¹ Medium (Installed Standard) 60° Beam angle	<input type="checkbox"/> SD347 347V - 240V Step Down Transformer
<input type="checkbox"/> LE07 700 lumens	<input type="checkbox"/> 97³ 97 CRI 3000K only	<input type="checkbox"/> 30 3000K	<input type="checkbox"/> PSRUNV 0-10V Driver + SR Ready Bridge, 120-277V	<input type="checkbox"/> VN Very Narrow 25° Beam angle	<input type="checkbox"/> SD480 480V - 240V Step Down Transformer
<input type="checkbox"/> LE10 1,000 lumens		<input type="checkbox"/> 35 3500K	<input type="checkbox"/> XT010UNV Signify 0-10V Driver 1% Dimming, 120-277V	<input type="checkbox"/> NR Narrow 40° Beam angle	<input type="checkbox"/> EM⁴ 10.7W Emergency Backup
<input type="checkbox"/> LE15 1,500 lumens		<input type="checkbox"/> 40 4000K	<input type="checkbox"/> LUT-1UNV Lutron EcoSystem 1% Dimming, 120-277V	<input type="checkbox"/> WD Wide 75° Beam angle	<input type="checkbox"/> EM⁴-CEC California Title 20 Compliant 10.7W Emergency Backup
<input type="checkbox"/> LE20 2,000 lumens		<input type="checkbox"/> 50 5000K	<input type="checkbox"/> LUT-5UNV Lutron EcoSystem 5% Dimming, 120-277V		<input type="checkbox"/> ES⁵ Philips EasySense ceiling mount sensor
<input type="checkbox"/> LE25 2,500 lumens			<input type="checkbox"/> LUT-L3DUNV Lutron Hi-lume 3-Wire 1% Dimming, 120-277V		<input type="checkbox"/> ENLS⁶-IL Enlighted Two Wire ENLIGHTED ONE Compact Sensor
			<input type="checkbox"/> ELD-E010UNV EldoLED ECOdrive 0-10V 1%, 120-277V		<input type="checkbox"/> ENLS⁶-CL Enlighted Two Wire CONNECTED LIGHTING Compact Sensor
			<input type="checkbox"/> ELD-EDALIUNV EldoLED ECOdrive DALI 1%, 120-277V		<input type="checkbox"/> ENLS⁶-IOT Enlighted Two Wire IOT Compact Sensor
			<input type="checkbox"/> ELD-S010UNV EldoLED SOLOdrive 0-10V 0.1%, 120-277V		<input type="checkbox"/> OUT Outdoor Debris Ingress Protection
			<input type="checkbox"/> ELD-SDALIUNV EldoLED SOLOdrive DALI 0.1%, 120-277V		<input type="checkbox"/> WET⁹ Field installable wet location gasketed ring

Reflectors

Shape	Finish
<input type="checkbox"/> ADS4 4" Square Reflector	<input type="checkbox"/> CC Clear Diffuse Trim and Flange <input type="checkbox"/> WH Matte White Trim and Flange

¹ Medium Lens Optic comes installed as standard, if other optic distribution selected the lens will ship separately and require field installation. / ³ CRI97 TRUE CHROMA is only available in 3000K only and is not Energy Star rated. / ⁴ EM cannot be combined with SD347 or SD480 option. / ⁵ Philips EasySense ceiling mounted sensor is only available with the PSRUNV driver. / ⁶ Enlighted Two Wire Compact Sensor with ceiling mount is only available with the PSRUNV driver. / ⁷ Options are factory installed and come with the Light Engine and Driver. / ⁸ LE05 is not available with LUT-5UNV. / ⁹ Wet location makes the downlight ETL certified for WET location installation, separate gasketed ring will be provided with the light engine for field installation.

SPECFIT 4" SQUARE

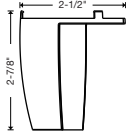
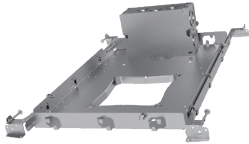
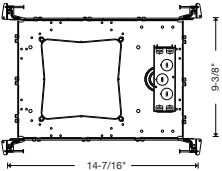
ACCESSORY ORDERING INFORMATION				
Product	Model	Description	Pictures	Dimensions
99079	ADWAW	Wall Wash (Field Installed on Module)		
35457	NCFJB4S	Square New Construction Plate with Junction Box 4"		

ORDERING GUIDE			
Light Engines		Reflector	
Product	Model	Product	Model
98060 / 35679	LES9027DIM010UNVMD / LES9027KDIM010UNVMD	98042	ADS4CC
98061 / 35680	LES9030DIM010UNVMD / LES9030KDIM010UNVMD	98043	ADS4WH
98062 / 35681	LES9035DIM010UNVMD / LES9035KDIM010UNVMD		
98063 / 35682	LES9040DIM010UNVMD / LES9040KDIM010UNVMD		
98534 / 35683	LES9050DIM010UNVMD / LES9050KDIM010UNVMD		
98064 / 35684	LES9730DIM010UNVMD / LES9730KDIM010UNVMD		
98065 / 35685	LEM9027DIM010UNVMD / LEM9027KDIM010UNVMD		
98066 / 35686	LEM9030DIM010UNVMD / LEM9030KDIM010UNVMD		
98067 / 35687	LEM9035DIM010UNVMD / LEM9035KDIM010UNVMD		
98068 / 35688	LEM9040DIM010UNVMD / LEM9040KDIM010UNVMD		
98535 / 35689	LEM9050DIM010UNVMD / LEM9050KDIM010UNVMD		
98069 / 35690	LEM9730DIM010UNVMD / LEM9730KDIM010UNVMD		

TECHNICAL INFORMATION						
Light Engine	Input Voltage	Input Frequency	Input Current	Input Power	THD Power	Power Factor
LESXXXX	120 / 277V	50 / 60Hz	0.115 / 0.047A	13W	<20%	>0.9
LEMXXXX	120 / 277V	50 / 60Hz	0.270 / 0.114A	31.5W	<20%	>0.9
LE05XXXX	120V	50 / 60Hz	0.056A	6.5W	<20%	>0.9
LE07XXXX	120V	50 / 60Hz	0.073A	8.5W	<20%	>0.9
LE10XXXX	120V	50 / 60Hz	0.112A	13W	<20%	>0.9
LE15XXXX	120V	50 / 60Hz	0.154A	18W	<20%	>0.9
LE20XXXX	120V	50 / 60Hz	0.218A	25.5W	<20%	>0.9
LE25XXXX	120V	50 / 60Hz	0.269A	31.5W	<20%	>0.9



SPECFIT 4" SQUARE

NOMINAL PERFORMANCE

LES (LE05 / LE07 / LE10) - Low / Medium / High - 6.5 / 8.5 / 12.5W

CCT	2700K			3000K			3500K			4000K			5000K		
	Low	Medium	High	Low	Medium	High	Low	Medium	High	Low	Medium	High	Low	Medium	High
Output**	Im LPW	Im LPW	Im LPW	Im LPW	Im LPW	Im LPW	Im LPW	Im LPW	Im LPW	Im LPW	Im LPW	Im LPW	Im LPW	Im LPW	Im LPW
Clear Diffuse	500 77	700 82	1,000 80	525 81	735 86	1,050 84	550 85	770 91	1,100 88	575 88	805 95	1,150 92	580 89	810 95	1,165 93
White	495 76	693 82	990 79	520 80	728 86	1,040 83	545 84	762 90	1,089 87	569 88	797 94	1,139 91	574 88	802 94	1,153 92
Black	440 68	616 72	880 70	462 71	647 76	924 74	484 74	678 80	968 77	506 78	708 83	1,012 81	510 78	714 84	1,015 81

** Lumen output are based on rated lumens, for exact value please refer to the IES files

LEM (LE15 / LE20 / LE25) - Low / Medium / High - 18.0 / 25.5 / 31.5W

CCT	2700K			3000K			3500K			4000K			5000K		
	Low	Medium	High	Low	Medium	High	Low	Medium	High	Low	Medium	High	Low	Medium	High
Output**	Im LPW	Im LPW	Im LPW	Im LPW	Im LPW	Im LPW	Im LPW	Im LPW	Im LPW	Im LPW	Im LPW	Im LPW	Im LPW	Im LPW	Im LPW
Clear Diffuse	1,600 89	2,125 83	2,500 79	1,632 91	2,169 85	2,550 81	1,664 92	2,210 87	2,600 83	1,696 94	2,253 88	2,650 84	1,713 95	2,275 89	2,677 85
White	1,584 88	2,104 82	2,475 78	1,616 90	2,147 84	2,525 80	1,647 91	2,188 86	2,574 82	1,679 93	2,230 87	2,624 83	1,696 94	2,252 88	2,650 84
Black	1,408 78	1,870 73	2,200 70	1,436 80	1,909 75	2,244 71	1,464 81	1,945 77	2,288 73	1,492 83	1,983 77	2,332 74	1,507 84	2,002 79	2,355 75

** Lumen output are based on rated lumens, for exact value please refer to the IES files

PHOTOMETRY

LES9035-DIM010-UNV-VN-ADS4CC

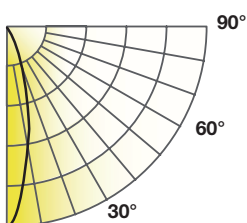

Lumens: 1,191 lm
 Power: 13 W
 Efficacy: 95 lm/W
 CRI: 90+
 Spacing Criteria: 0.44
 Beam Angle: 27°

Candlepower Distribution		Initial Footcandles			Zonal Lumen Summary		
Angle (°)	Average (cd)	Height (ft)	Fc	Diameter (ft)	Zone	Lumens	%Fixt
10	2,609	4	269	1.9	0-30	1,051	88%
20	1,031	6	120	2.9	0-40	1,128	95%
30	179	8	67	3.8	0-60	1,185	100%
40	90	10	43	4.8	0-90	1,191	100%
50	27	12	30	5.7			
60	6						
70	2						
80	0						
90	0						



SPECFIT 4" SQUARE

PHOTOMETRY

LES9035-DIM010-UNV-NR-ADS4CC

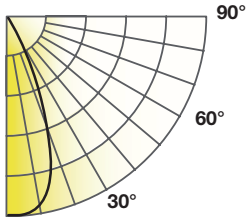

Lumens: 1,215 lm
 Power: 12.3 W
 Efficacy: 98 lm/W
 CRI: 90+
 Spacing Criteria: 0.67
 Beam Angle: 46°

Candlepower Distribution		Initial Footcandles			Zonal Lumen Summary		
Angle (°)	Average (cd)	Height (ft)	Fc	Diameter (ft)	Zone	Lumens	%Fixt
10	2,153	4	129	3.0	0-30	1,068	88%
20	1,477	6	57	4.5	0-40	1,167	96%
30	339	8	32	6.0	0-60	1,210	100%
40	72	10	21	7.6	0-90	1,215	100%
50	20	12	14	9.1			
60	5						
70	1						
80	0						
90	0						

LES9035-DIM010-UNV-MD-ADS4CC

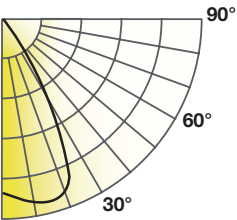

Lumens: 1,226 lm
 Power: 12.3 W
 Efficacy: 99 lm/W
 CRI: 90+
 Spacing Criteria: 1.0
 Beam Angle: 69°

Candlepower Distribution		Initial Footcandles			Zonal Lumen Summary		
Angle (°)	Average (cd)	Height (ft)	Fc	Diameter (ft)	Zone	Lumens	%Fixt
10	1,153	4	74	4.2	0-30	906	74%
20	1,238	6	33	6.4	0-40	1,160	95%
30	704	8	18	8.5	0-60	1,221	100%
40	137	10	12	10.6	0-90	1,226	100%
50	26	12	8	12.8			
60	6						
70	2						
80	0						
90	0						

LES9035-DIM010-UNV-WD-ADS4CC

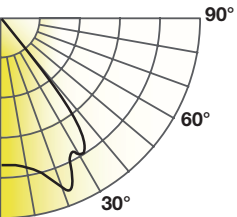

Lumens: 1,218 lm
 Power: 12.5 W
 Efficacy: 98 lm/W
 CRI: 90+
 Spacing Criteria: 1.2
 Beam Angle: 82°

Candlepower Distribution		Initial Footcandles			Zonal Lumen Summary		
Angle (°)	Average (cd)	Height (ft)	Fc	Diameter (ft)	Zone	Lumens	%Fixt
10	654	4	43	6.4	0-30	628	52%
20	771	6	19	9.7	0-40	1,068	88%
30	746	8	11	12.9	0-60	1,206	99%
40	438	10	7	16.1	0-90	1,218	100%
50	54	12	5	19.4			
60	13						
70	4						
80	1						
90	0						



SPECFIT 4" SQUARE

PHOTOMETRY

LEM9035-DIM010-UNV-VN-ADS4CC

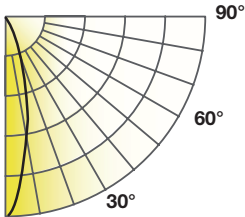

Lumens: 2,468 lm
 Power: 31.0 W
 Efficacy: 80 lm/W
 CRI: 90+
 Spacing Criteria: 0.42
 Beam Angle: 25°

Candlepower Distribution		Initial Footcandles			Zonal Lumen Summary		
Angle (°)	Average (cd)	Height (ft)	Fc	Diameter (ft)	Zone	Lumens	%Fixt
10	5,647	4	585	1.8	0-30	2,181	88%
20	2,065	6	217	2.9	0-40	2,337	95%
30	381	8	97	4.3	0-60	2,454	98%
40	201	10	54	5.8	0-90	2,468	100%
50	60	12	35	7.2			
60	14						
70	4						
80	1						
90	0						

LEM9035-DIM010-UNV-NR-ADS4CC

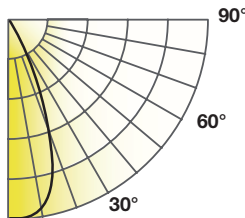

Lumens: 2,508 lm
 Power: 31.0 W
 Efficacy: 81 lm/W
 CRI: 90+
 Spacing Criteria: 0.72
 Beam Angle: 49°

Candlepower Distribution		Initial Footcandles			Zonal Lumen Summary		
Angle (°)	Average (cd)	Height (ft)	Fc	Diameter (ft)	Zone	Lumens	%Fixt
10	4,582	4	276	2.6	0-30	2,231	89%
20	2,831	6	121	3.9	0-40	2,412	96%
30	650	8	68	5.2	0-60	2,498	100%
40	151	10	44	6.5	0-90	2,508	100%
50	45	12	30	7.9			
60	10						
70	3						
80	1						
90	0						

LEM9035-DIM010-UNV-MD-ADS4CC

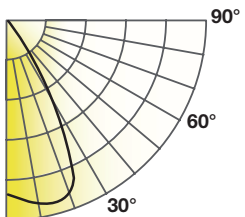

Lumens: 2517 lm
 Power: 30.95 W
 Efficacy: 81.17 lm/W
 CRI: 90+
 Spacing Criteria: 1.0
 Beam Angle: 71°

Candlepower Distribution		Initial Footcandles			Zonal Lumen Summary		
Angle (°)	Average (cd)	Height (ft)	Fc	Diameter (ft)	Zone	Lumens	%Fixt
10	2203	4	161	4.2	0-30	1852	74%
20	2885	6	72	6.4	0-40	2389	95%
30	1436	8	40	8.5	0-60	2506	100%
40	275	10	26	10.6	0-90	2517	100%
50	47	12	18	12.8			
60	11						
70	3						
80	1						
90	0						

SPECFIT 4" SQUARE

PHOTOMETRY

LEM9035-DIM010-UNV-WD-ADS4CC

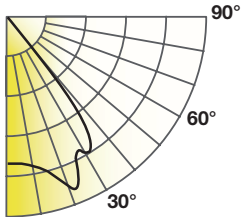

Lumens: 2471 lm
 Power: 31.5 W
 Efficacy: 78 lm/W
 CRI: 90+
 Spacing Criteria: 1.225
 Beam Angle: 83°

Candlepower Distribution		Initial Footcandles			Zonal Lumen Summary		
Angle (°)	Average (cd)	Height (ft)	Fc	Diameter (ft)	Zone	Lumens	%Fixt
10	1317	4	81	6.4	0-30	1216	49%
20	1494	6	30	9.7	0-40	2157	29%
30	1591	8	13	12.9	0-60	2445	99%
40	1040	10	8	16.1	0-90	2471	100%
50	134	12	5	19.4			
60	34						
70	11						
80	3						
90	0						

LES9730-DIM010-UNV-MD-ADS4CC

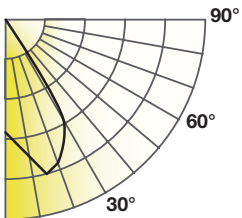

Lumens: 1032 lm
 CBCP: 1067 cd
 Power: 13 W
 Efficacy: 83 lm/W
 CRI: 96
 Spacing Criteria: 1.14
 Beam Angle: 63.5°

Candlepower Distribution		Initial Footcandles			Zonal Lumen Summary		
Angle (°)	Average (cd)	Height (ft)	Fc	Diameter (ft)	Zone	Lumens	%Fixt
10	870	4	81	5.0	0-30	724	70%
20	987	6	36	7.4	0-40	971	94%
30	594	8	20	9.9	0-60	1030	100%
40	185	10	13	12.4	0-90	1032	100%
50	18	12	9	14.9			
60	1						
70	1						
80	0						
90	0						

LEM9730-DIM010-UNV-MD-ADS4CC

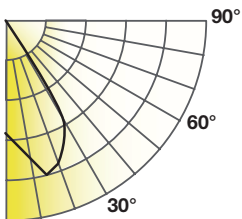

Lumens: 2165 lm
 CBCP: 2236 cd
 Power: 33 W
 Efficacy: 66 lm/W
 CRI: 96
 Spacing Criteria: 1.14
 Beam Angle: 64°

Candlepower Distribution		Initial Footcandles			Zonal Lumen Summary		
Angle (°)	Average (cd)	Height (ft)	Fc	Diameter (ft)	Zone	Lumens	%Fixt
10	1,822	4	169	5.0	0-30	1518	70%
20	2,061	6	75	7.4	0-40	2036	94%
30	1,242	8	42	9.9	0-60	2159	100%
40	399	10	27	12.4	0-90	2165	100%
50	38	12	19	14.9			
60	8						
70	3						
80	1						
90	0						



SPECFIT 4" SQUARE

COLOR ACCURACY & SPECTRAL DISTRIBUTION FOR 97 CRI WITH TRUE CHROMA

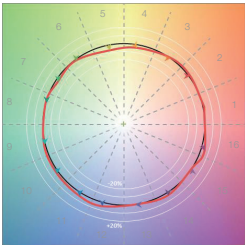
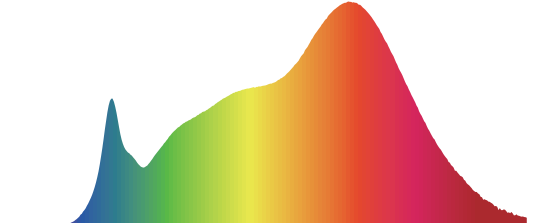
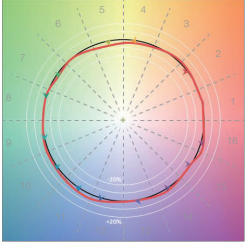
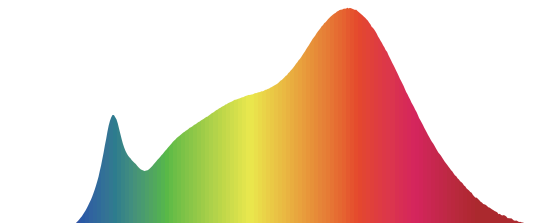

CCT	COLOR ACCURACY	SPECTRAL POWER DISTRIBUTION
LES9730DIM010UNVMD	 <p>Rf: 93, Rg: 101</p>	 <p>Wavelength (nm)</p>
LEM9730DIM010UNVMD	 <p>Rf: 94, Rg: 101</p>	 <p>Wavelength (nm)</p>

Rf: TM-30 metric measuring color fidelity (whether colors are similar to those under natural light). Rf is a more accurate version of the CRI Ra. Rf is 100 for natural light.
 Rg: TM-30 metric measuring color gamut (whether colors are more saturated than under natural light). Rg is 100 for natural light.

Note: All rights reserved. All sizes and specifications are subject to change at any time without notice.