

AUDIA

ACOUSTIX - STATIC WHITE, BIOS ST/DY

LUMENWERX

Project: _____

Type: _____

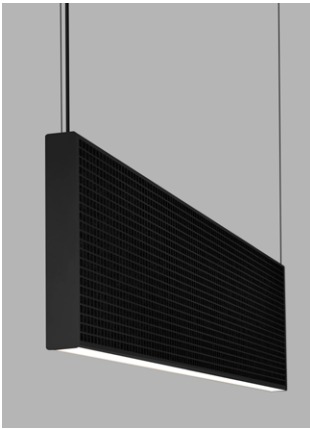

Full perforation

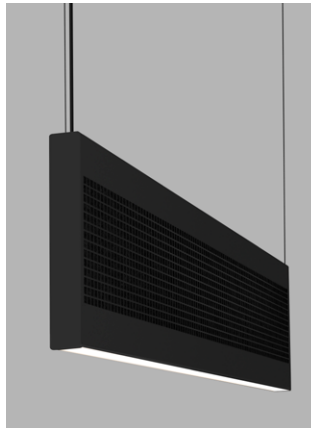

Half perforation

Section View

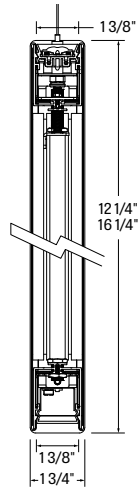

Direct/Indirect

Our premium acoustic offering Audia uses the science of Helmholtz resonance to trap acoustic waves through aluminum lattice, wrapped around proprietary sound absorbing material. With its slim core, narrow body and multiple color options, Audia was designed from the ground up with sound and light engineering in mind. Using our patent pending EchoCore™ technology we have constructed layers of sound absorbing material coupled with precise air pockets into a patterned aluminum body with a curved soft regress light reveal without compromising luminaire performance in our HLO (High-efficiency Lambertian optic) optics that delivers excellent efficacy. Audia is available in Static White and Bios biologically optimized options. Chromawerx QUADRO, DUO and SOLA are also available, see separate spec sheets.

Performance

Based on 3500K, 80CRI

DISTRIBUTION	TOTAL LUMENS PER 4FT	EFFICACY lm/W
Direct	2000 lm	74 lm/W
Direct/Indirect	4400 lm	94 lm/W
Indirect (WIO2)	3000 lm	108 lm/W

Order Guide

LUMINAIRE ID	DISTRIBUTION	DIRECT OPTICS	INDIRECT OPTICS	LIGHT SOURCE	CRI	DIRECT LUMEN PACKAGES	INDIRECT LUMEN PACKAGES
		HLO	WIO2				
AUDFACOP - Audia Full Perforation Pendant AUDHACOP - Audia Half Perforation Pendant	DI ¹ - Direct/Indirect D - Direct I ¹ - Indirect ¹ Not available with BIOS.	HLO - High-Efficiency Lambertian Optic	WIO2 - Widespread Indirect Optic	SW - Static white BIOSST - Static biologically-optimized lighting BIOSDY - Dynamic biologically-optimized lighting	80 - 80CRI 90 ² - 90CRI ² Not available with BIOS.	350 - Min. low output 350lm/ft 500 - Medium output 500lm/ft 750 ^{3,4} - Max. high output 750lm/ft ³ Not available with BIOS. ⁴ For DI fixtures, the max. high output (750lm/ft) can only be combined with 500lm/ft output or less.	350 - Min. low output 350lm/ft 500 - Medium output 500lm/ft 750 ^{3,4} - Max. high output 750lm/ft

COLOR TEMP	LUMINAIRE LENGTH	LUMINAIRE HEIGHT	VOLTAGE	DRIVER	ELECTRICAL
27 ⁵ - 2700K 30 - 3000K 35 - 3500K 40 - 4000K ⁵ Not available with BIOS.	Standard individual sections (nominal length): 4', 8', 12' Continuous runs: lengths over 12' #FT ⁶ - specify nominal length (#) in 4 foot increments ⁶ Consult factory for other lengths.	12 - 12 inches 16 - 16 inches	120 -120V 277 - 277V UNV - 120V-277V 347 ⁷ - 347V ⁷ Not available with Lutron.	D1 - 1% 0-10V DA ⁸ - DALI LTEA2W - Lutron 1% - 2 wire FP 120V LDE1 ⁸ - Lutron Hi-lume 1% Eco LDE5 ⁸ - Lutron 5% EcoSystem ⁸ On-site commissioning is required.	1 - 1 circuit 2 - 2 circuits +#EB ⁹ - Emergency battery +#EM - Emergency light circuit +#NL - Night light circuit ⁹ Not available with BIOS-DY.

MOUNTING	FIXTURE FINISH	PERFORATION OPTION	FIXTURE INTERIOR COLOR	OPTIONS																				
53WAC36W ¹⁰ - 36" aircraft cable, white canopies (5" power + 3" non-power), white power cord 53WAC36B ¹⁰ - 36" aircraft cable, white canopies (5" power + 3" non-power), black power cord 55WSW18 - 18" white stem, white canopies (5" power + 5" non power) ¹⁰ Power cord is 6" longer than suspension length. Consult factory for other lengths. For all other options, refer to our Pendant Mounting Guide	AL - Aluminum B - Matte black W - Matte white CF# - Custom finish, specify RAL#	SQ - Square RD - Round CP# - Custom perforation	<table border="0"> <tr> <td> FWT</td> <td> LMT</td> <td> IVT</td> <td> IGT</td> </tr> <tr> <td> TBT</td> <td> LNT</td> <td> LET</td> <td> SYT</td> </tr> <tr> <td> CDT</td> <td> OGT</td> <td> SDT</td> <td> BLT</td> </tr> <tr> <td> TPT</td> <td> CYT</td> <td> CFT</td> <td> MDT</td> </tr> <tr> <td> FOT</td> <td> PMT</td> <td> MOT</td> <td></td> </tr> </table>	FWT	LMT	IVT	IGT	TBT	LNT	LET	SYT	CDT	OGT	SDT	BLT	TPT	CYT	CFT	MDT	FOT	PMT	MOT		FU - Fuse TB# - T-bar caddy clip, specify grid size TG# - Tegular caddy clip, specify grid size ST - Screw slots caddy clip CU - Custom
FWT	LMT	IVT	IGT																					
TBT	LNT	LET	SYT																					
CDT	OGT	SDT	BLT																					
TPT	CYT	CFT	MDT																					
FOT	PMT	MOT																						

3737 Cote Vertu St-Laurent, Quebec, Canada H4R 2C9
T (514) 225-4304 F (514) 931-4862

www.lumenwerx.com



Lumenwerx reserves the right to modify product specifications without notification.
© Lumenwerx, ULC. All rights reserved.
AUDIA-SW-SPEC-REV6 February 20, 2023



Project: _____

Type: _____

Fixture Interior Colors



FWT - FROST WHITE



LMT - LIME

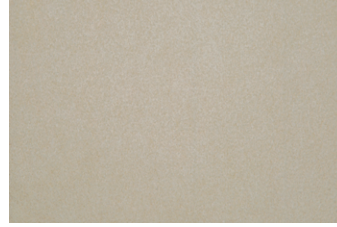

IVT - IVORY



IGT - ICEBERG

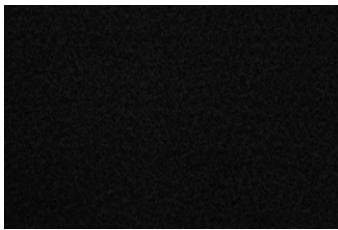

TBT - TRUE BLACK



LNT - LEMON



LET - LATTE

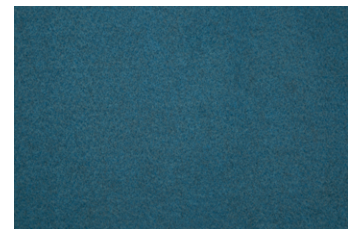

SYT - SKY



CDT - CLOUDY



OGT - ORANGE



SDT - SAND



BLT - BLUEBERRY



TPT - TAUPE

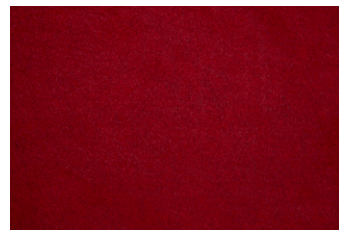

CYT - CHERRY



CFT - CAFÉ



MDT - MIDNIGHT BLUE



FOT - FOG

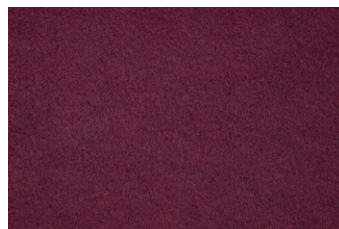

PMT - PLUM



MOT - MOCHA

Project: _____

Type: _____

DIMENSIONS

Section Views

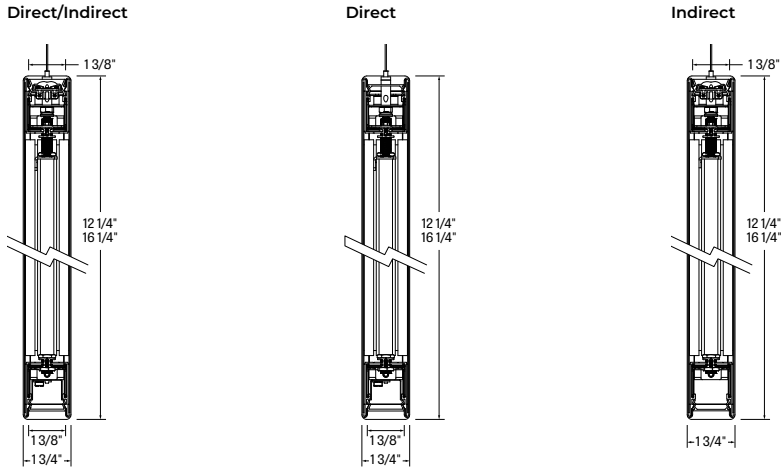

Front Views

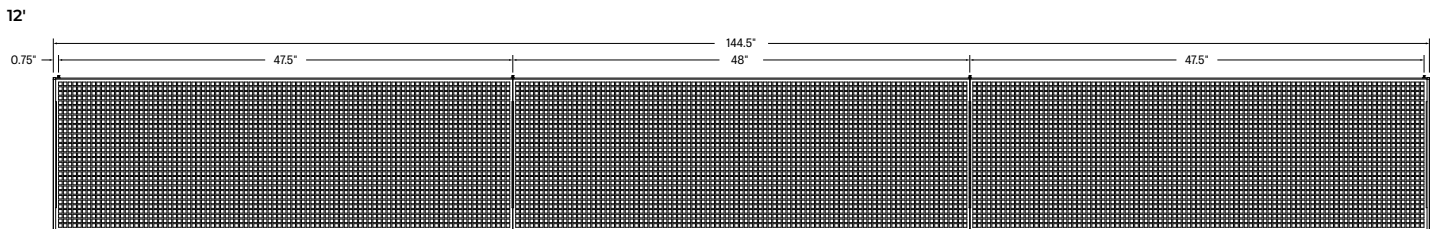
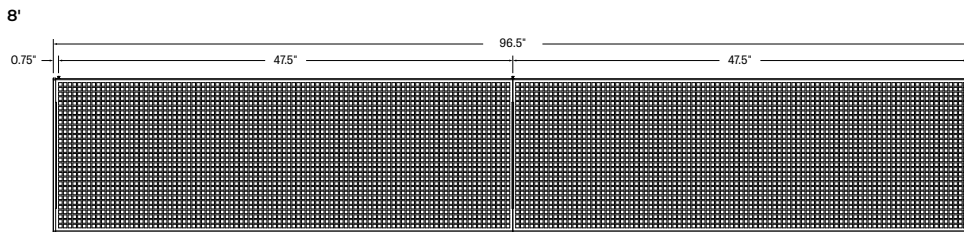
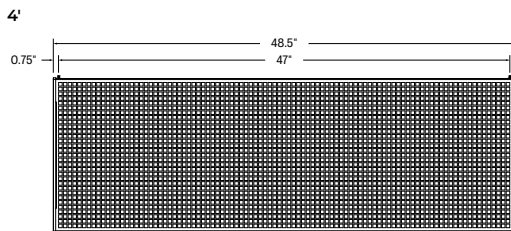

ACOUSTIC CALCULATOR

Using the Lumenwerx Acoustix Value Calculator table, you can determine the number of acoustic luminaires required in a space by fixture type. We have three levels of recommended sound reduction: good, better, and best. Choosing one of these options will reduce the sound accordingly. The best option indicates the best acoustic improvement. Calculations are based on a standard ceiling height of 9 feet.



- ① Calculate the square feet of your room (L x W).
- ② Choose the level of acoustical improvement you are looking for, and find the corresponding value based on your room dimension and luminaire configuration.

% in reduction in reverberation time		
😊	GOOD	25%
😊😊	BETTER	40%
😊😊😊	BEST	50%

LENGTH	HEIGHT	Room dimensions under 300 sq ft			Room dimensions over 300 sq ft		
		GOOD 😊	BETTER 😊😊	BEST 😊😊😊	GOOD 😊	BETTER 😊😊	BEST 😊😊😊
4 Feet	12"	38	19	12	60	29	19
	16"	51	25	17	84	39	26
8 Feet	12"	76	38	24	120	58	38
	16"	102	50	34	168	78	52
12 Feet	12"	114	57	36	180	87	57
	16"	153	75	51	252	117	78

- ③ Use the Lumenwerx Acoustix Value Formula to determine the number of luminaires needed in the room.

$$\text{Square feet} \div \text{Value} = \text{Number of luminaires}$$

Example:

Luminaires: Audia, 4 ft long, 16" high
Room square feet: L: 20 ft x W: 18 ft = 360 sq ft
Desired acoustical improvement: Better = 39
Number of luminaires needed in the room: $360 \div 39 = 10$ luminaires

NOTES:

- You can mix lit and blank fixtures.
- Lumenwerx acoustic calculators were developed to act as a guide. For precise acoustic performance in a space, please consult an acoustician.

Technical Specifications

OPTICS

High-Efficiency Lambertian Optic (HLO) - shielding of diffusing 0.075" thick acrylic with up to 88% transmission and good source obscuration. Luminaire brightness is controlled by the flux-to-shielding area ratio.

Widespread Indirect Optic (WIO2) - Vertically oriented LED arrays couple light into a linear light guide. A specially designed TIR/microstructure extracts light into the desired "batwing" distribution with smooth ceiling brightness and wide spacing.

LIGHT SOURCE - LED

Custom linear array of mid-flux LEDs are cartridge-mounted with quick-connect wiring to facilitate service and thermal management. Available in 2700K, 3000K, 3500K and 4000K with a minimum 80 CRI and an option for 90 CRI with elevated R9 value. Color consistency maintained to within 3 SDCM. LEDs operate at reduced drive current to optimize efficacy and lumen maintenance.

LUMINAIRE LENGTH

Audia is made up of standard 4, 8, and 12 foot individual sections that may be joined together to create longer continuous run lengths. Exact run length must be noted in the product code. The minimum individual section available is 4 feet, and continuous run lengths can be ordered in 4-foot increments.

All individual sections are joined together onsite using the joiner kits provided. Lumenwerx joiner kits are extremely simple to work with in the field and result in a fixture that appears virtually seamless with no light leak at any connection.

ELECTRICAL

Factory-set, adjustable output current LED driver with universal (120-277VAC) input. Dimmable from 100% to 1% with 0-10V dimming control. Rated life (90% survivorship) of 50,000 hours at 50°C max. ambient (and 70°C max. case) temperature. At maximum driver load: Efficiency>84%, PF>0.9, THD<20%. Other specifiable options include Lutron Hi-Lume 1% (specify 2-wire, or Ecosystem Dim-to-Off), Lutron 5-Series (5% Ecosystem), and DALI protocol drivers. All of our standard 0-10V drivers are NEMA 410 compliant.

EMERGENCY REMOTE

Factory installed long life high temperature recyclable Ni-Cad battery pack with test switch and charge indicator, minimum of 90 minutes operation, up to 1000 lumens per 4ft (25°C) emergency lighting output. Recharge time of 24 hours.

WEIGHT

Direct - Audia 4ft: 16.16lbs - 7.3kg

Direct/Indirect - Audia 4ft : 17.86lbs - 8.10kg

Indirect - Audia 4ft: 16.16lbs - 7.3kg

MOUNTING OPTIONS

For cable-mounted fixtures - 53WAC36 (5" white canopy for all power mounting point, 3" white canopy for non power mounting point, and a 36" cable)

For stem mounted fixtures - 55WSW18 (5" white canopy for all power mounting point, and non power mounting point, and a 18" white stem)

Caddy clips, if required specify under OPTIONS

CONSTRUCTION

Housing - Extruded aluminum (0.095" nominal) up to 90% recycled content

Interior brackets - Die formed cold rolled sheet steel 18 gauge thick

Joining system - Die cast zinc (0.95" nominal)

Reflectors - Cold rolled steel 0.024" thick precisely die formed, 95% reflective matte white painted

Diffuser - 0.075" thick acrylic, 88% transmission

Perforated panel - Die cut aluminum panel (18 gauge aluminum sheet)

End caps - Die cast aluminum (0.95" nominal)

Hanger - Chromed Griplock securely attached with spring steel hardware in end caps and/or joiners

Aircraft cable suspension - 7x7 braids aluminum aircraft cable 0.06" thick

Stem - 0.5" diameter threaded steel tube matte white or aluminum powder coating. Custom finishes are also available.

FINISH

Interior - 95%, reflective matte powder coated white paint

Exterior - powder-coat paint in standard white, black, or aluminum. Custom colors are available (provide RAL #).

ACOUSTIC FINISH

Material is 100% polyester containing up to 50% of recycled plastic bottles (PET) with an ASTM E-84 Class A fire rating and is moisture resistant.

CARE

Remove dust and debris by wiping down with a clean, dry or damp, soft, lint-free cloth, or vacuum

ENVIRONMENT

Ambient temperature at fixture location shall not exceed 30°C/86°F, indoor use, dry or damp locations.

CERTIFICATIONS:

ETL - Rated for Indoor Dry/Damp locations. Conforms to UL Standard 1598 and certified to CAN/CSA Standard C22.2 No. 250.0.

WARRANTY

Lumenwerx provides a five-year limited warranty of electrical and mechanical performance of the luminaires, including the LED boards, drivers, and auxiliary electronics. Lumenwerx will repair or replace defective luminaires or components at our discretion, provided they have been installed and operated in accordance with our specifications. Other limitations apply, please refer to the full warranty on our website.

AUDIA

ACOUSTIX - STATIC WHITE, BIOS ST/DY

LUMENWERX

Project: _____

Type: _____



WELL for Light - The WELL building standard focuses on light quality in several features. There are three categories that are fully attributed to the construction and features of a luminaire. In WELL V1, it's Feature 54 Circadian Lighting, Feature 55 Glare Control, and Feature 58 Color Quality. In WELL V2, it's Feature L03 Circadian Lighting, Feature L04 Glare Control, and Feature L07 Electric Light Quality.

This fixture meets Features:

- Feature 54 or L03 when BIOS LED is selected
- Feature 55 or L04 meets WELL glare category (a-c-d)
- Feature 58 or L07 when 90CRI is selected

All LED drivers used at Lumenwerx are deemed to have a low risk level of flicker, of 5 % or less below 90Hz operational as defined by IEEE standard 1789-2015 LED.



WELL for Sound - This luminaire is recommended for use as an acoustical absorption surface to limit reverberation times (RT) in a given space. This luminaire contributes to noise reduction and vibration dampening to promote focus and concentration. Reverberation needs to be calculated in each space based on the materials used.



WELL for Mind -This luminaire meets WELL for mind as it is a human centric luminaire offering quality light, excellent color, smooth optics, and a sound diminishing element. If any of these features are incorporated in a luminaire, it can improve the ability to focus, concentrate, and persist longer on a given task. This fixture harmoniously operates in a space to assist the mind.

For more information please contact well@lumenwerx.com.



BIOS SkyBlue™ Technology is designed to provide the specific circadian stimulus to improve overall sleep quality, recovery during the night, and overall feelings of well-being. The non-visual light signals that stimulate our circadian system have peak intensity in the "sky blue" region. As the diagram below illustrates, BIOS SkyBlue technology shifts the peak LED spectral intensity (460 nm) to align better with the peak response of circadian stimulus. Also note the enhanced deep-red (near 660 nm) spectrum.

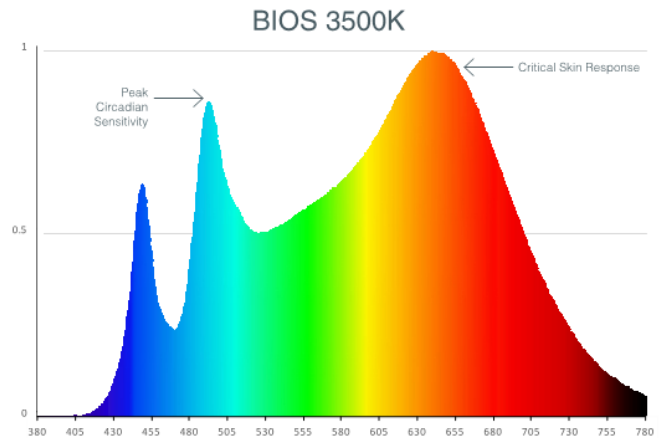

Photometrics

Please follow the multiplier tables to ensure correct lumen value lensing CCT and CRI will change the lumen output.

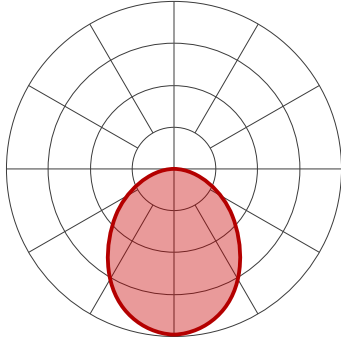

DIRECT

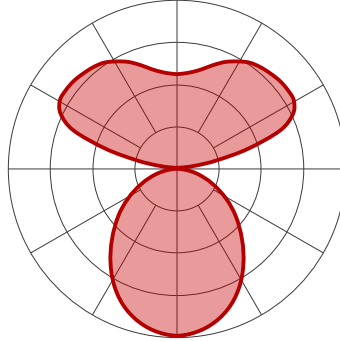

DIRECT/INDIRECT

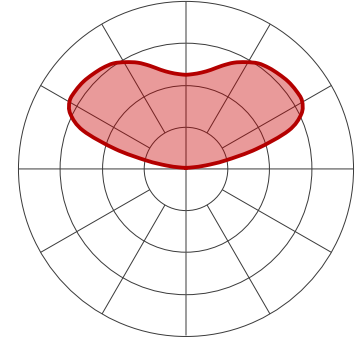

INDIRECT

DIRECT

HLO-FH Delivered Lumens for Flush at 35K 80CRI

Lumens per Foot	Total Lumens Per 4FT	Input Watts	LPW
350	1400	19.5	72
500	2000	27	74
750	3000	41	73

DIRECT

Multiplier - CCT/CRI

CCT (K)	Watts Multiplier		LPW Multiplier	
	CRI80	CRI90	CRI80	CRI90
2700	1.05	1.26	0.95	0.79
3000	1.01	1.23	0.99	0.81
3500	1.00	1.20	1.00	0.84
4000	1.00	1.17	1.00	0.85

DIRECT/INDIRECT

HLO-FH-WIO2 Delivered Lumens for Flush at 35K 80CRI

Lumen Package (Direct + Indirect)	Direct	Indirect	Total Lumens Per 4FT	Input Watts	LPW
350+350	1400	1400	2800	32.47	86
350+500	1400	2000	3400	38.21	89
350+750	1400	3000	4400	47.04	94
500+350	2000	1400	3400	40.15	85
500+500	2000	2000	4000	45.89	87
500+750	2000	3000	5000	54.72	91
750+350	3000	1400	4400	54.47	81
750+500	3000	2000	5000	60.2	83

DIRECT/INDIRECT

Multiplier - CCT/CRI

CCT (K)	Watts Multiplier		LPW Multiplier	
	CRI80	CRI90	CRI80	CRI90
2700	1.04	1.06	0.96	0.96
3000	1.01	1.09	0.97	0.92
3500	1.00	1.08	1.00	0.93
4000	0.98	1.06	1.02	0.95

INDIRECT

WIO2 Delivered Lumens at 35K 80CRI

Lumens per Foot	Total Lumens Per 4FT	Input Watts	LPW
350	1400	13.11	107
500	2000	18.84	106
750	3000	27.67	108

INDIRECT

Multiplier - CCT/CRI

CCT (K)	Watts Multiplier		LPW Multiplier	
	CRI80	CRI90	CRI80	CRI90
2700	1.04	1.06	0.96	0.96
3000	1.01	1.09	0.97	0.92
3500	1.00	1.08	1.00	0.93
4000	0.98	1.06	1.02	0.95