

CHIOBO

Radial Emission LED Bollard

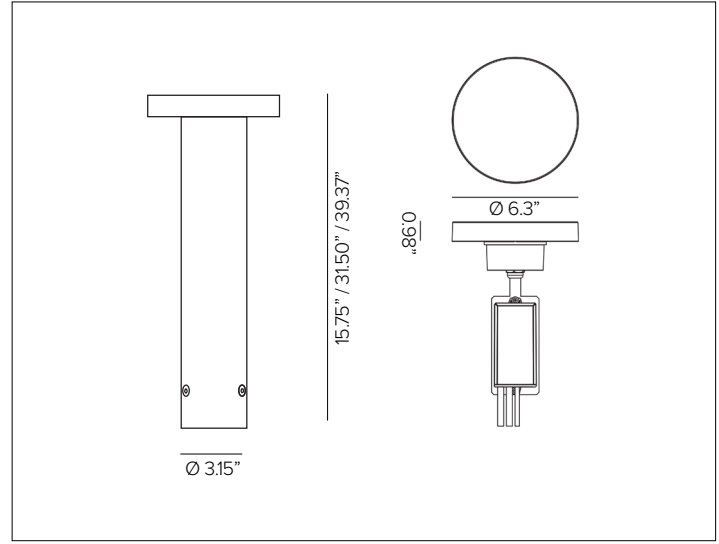
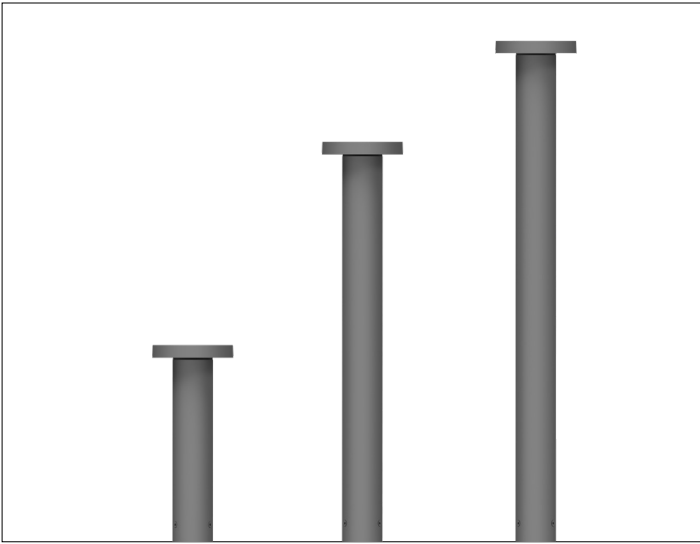

CONCEPT

Radial-emission LED bollard specifically designed to light large open spaces.

FIXTURE MECHANICAL CHARACTERISTICS

Housing	Ø 6.3" Dia. Top with Ø 3.15" Dia. Post
Materials	Powder coated anodized die-cast aluminum optical head with extruded body. Marine Grade cataphoresis ^E available as optional.
Finish	Textured finish. <ul style="list-style-type: none"> ● Ferrite Dark Grey ● Black ● White ● Bronze ● Sandstone Grey ● Heritage Brown
Power Connection	Factory shipped with DSM&T IP68 quick disconnect at fixture and mating 4ft SJOOW 18-6 cable with purple and grey wires for 0-10V.
Functionality	Available in three different heights - 15.75in, 31.50in and 39.37in. 316L grade stainless steel base and stainless steel anti-theft screws.
BUG	B0-U0-G0 Dark Sky Compliant
Weight	2.98lbs (fixture head only)
Protection	IP66
Resistance	IK10

CERTIFICATIONS

cULus Wet Location Listed.
 Tested in accordance with LM-79-08.
 Compliant for California installations.
 IEC 62471
 RoHS3 EU 215/863

WARRANTY

5 year limited warranty.

SUSTAINABILITY

Luminaire designed for disposal/recycling at end-of-life. Replaceable LED light source and control gear by a Targetti technician.

ELECTRICAL CHARACTERISTICS

Driver	Integral 4/1 smart driver (Non-Dimmable / 0-10V / Reverse Phase / Forward Phase).
Wattage	20W (360°) / 14W (180°, 90°+90°) / 9W (90°)
Voltage	Universal Voltage 120-277V AC 50/60Hz

SOURCE

LED Chip on Board.

TM30	CCT (Nominal)	CRI	Rf	Rg	SDCM
2700K	2700K	80	82	96	2
3000K	3000K	80	83	96	2
3500K	3500K	80	83	95	2
4000K	4000K	80	82	95	2

Ra90 available upon request

OPTIC

Internal high reflective anodized aluminum reflector with transparent polycarbonate lens positioned horizontally under optical head with external black anti-glare control.

Beam	360°	180°	90°	90°+90°
Delivered Lumens	2700K 878Lm 3000K 915Lm 3500K 931Lm 4000K 939Lm	470Lm	232Lm	485Lm 506Lm 514Lm 519Lm
Efficacy	47Lm/W max. Refer to photometric graphs for specific values.			
Lifetime	14W / 9W version: L92/B10 30000hrs at max TA +25°C L90/B10 50000hrs at max TA +25°C 20W version only: L89/B10 30000hrs at max TA +25°C L84/B10 50000hrs at max TA +25°C			

Photobiological Classification Low risk safety RG1

CHIOBO

SPECIFICATION INFORMATION



Ex: CBB414036L330FE / 1US4033 / 1US2530

1 - PRODUCT CODE	3 - DRIVER	4 - HEIGHT	5 - EMISSION	6 - WATTAGE	6 - KELVIN	7 - FINISH
CBB — CHIOBO	41 — 4/1 Smart Dimming (Non-Dimming / 0-10V / Reverse Phase / Forward Phase)	16 — 16in	36 ^D — 360°	L3 — 20W	27 — 2700K	FE — Ferrite Dark Grey
		32 — 32in	18 ^C — 180°	L2 — 14W	30 — 3000K	HB — Heritage Brown
		40 — 40in	99 ^C — 90°+90°	L1 — 9W	35 — 3500K	BZ — Bronze
			90 ^B — 90°		40 — 4000K	WT — White
						BT — Black
						SG — Sandstone Grey
						RAL — Custom RAL

8 - OPTIONAL	9 - MOUNTING	10 - INSTALLATION
— — Blank no option	Trimless Anchor Base <i>See section for details</i>	J-Box with sleeve <i>See section for details</i>
MG ^E — Marine Grade	Plate for Surface Installation <i>See section for details</i>	
	Ground Anchor Base <i>See section for details</i>	

^B 90° optic only available in 9W nominal.

^C 90°+90° and 180° optics only available in 14W nominal.

^D 360° optic only available in 20W nominal.

^E Marine Grade is recommended for use in environments with occasional exposure to salt air, reclaimed water, fertilizers, chemical cleaners, or frequent pressure washing (steam) cleaning. Fixture housing complete with marine grade cataphoresis suitable for use in marine grade environments. Not to be in direct contact with salt or corrosive agents for extended periods of time.

CHIOBO

9 – MOUNTING (REQUIRED)

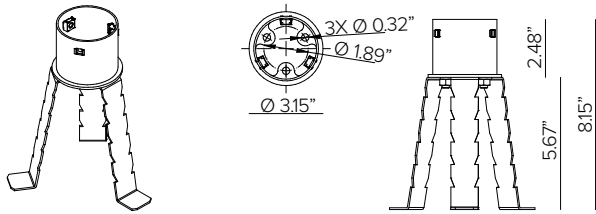

Trimless mounting base with ground anchor fixing rods for installation in concrete. AISI 316 stainless steel. Mounting bolts included. **Junction box provided by others.**

Part No. **1US4033**

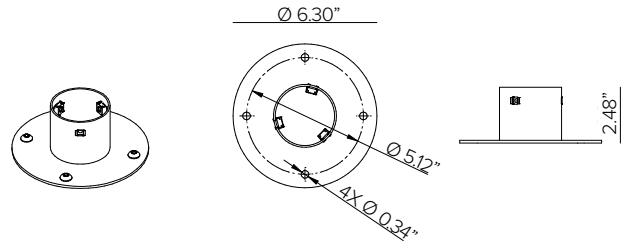

Powder coated mounting plate for surface installation outside the post. AISI 316 stainless steel compatible with dowels to be inserted into 4 holes, Ø 0.34" Dia. for use with 5/16" bolts maximum. Anchor bolts not included. **Required for use with 1US2530 by NEC.**

Part No. **1US40351(*)**

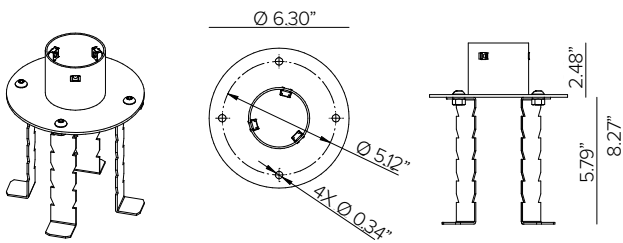

Powder coated mounting base with ground anchor fixing rods for installation in concrete. AISI 316 stainless steel. Mounting bolts included. **Required for use with 1US2530 by NEC.**

Part No. **1US40352(*)**

- Ferrite Dark Grey (Default)
- Heritage Brown (HB)*
- Bronze (BZ)*
- White (WT)*
- Black (BT)*
- Sandstone Grey (SG)*

*Add suffix to end of number to identify finish (EX. 1US4035HB)

10 – INSTALLATION (REQUIRED)

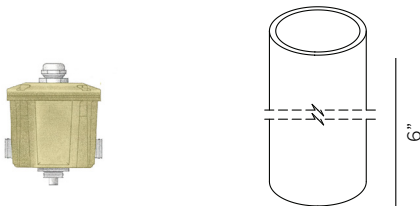

Direct burial brass ingrade j-box with PVC sleeve. Features stainless steel cover screws and strain relief for power cord, (2) 3/4" NPT bottom holes and (2) 3/4" NPT side holes. Includes (4) 3/4" to 1/2" adapters and (2) 1/2" NPT plugs. **(REQUIRED by NEC).**

Part No. **1US2530**

CHIOBO

PHOTOMETRY

360° EMISSION

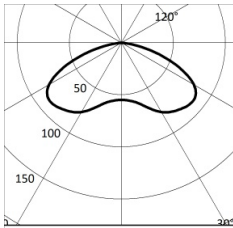
	2700K	H(m)	D(m)	Emax(lx)		
	Ra80			143°		
	Fixture Power	20W	1	5.90	136	
	Source Flux	2489lm	2	11.81	34	
	Fixture Flux	878lm	3	17.71	15	
	Efficacy	44lm/W	4	23.61	9	
TS1587	Imax=88cd/klm	Imax	220cd	5	29.51	5

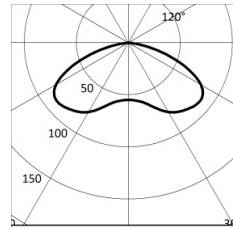
	3000K	H(m)	D(m)	Emax(lx)		
	Ra80			143°		
	Fixture Power	20W	1	5.90	142	
	Source Flux	2595lm	2	11.81	36	
	Fixture Flux	915lm	3	17.71	16	
	Efficacy	46lm/W	4	23.61	9	
TS1587	Imax=88cd/klm	Imax	230cd	5	29.51	6

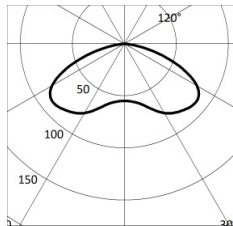
	3500K	H(m)	D(m)	Emax(lx)		
	Ra80			143°		
	Fixture Power	20W	1	5.90	144	
	Source Flux	2640lm	2	11.81	36	
	Fixture Flux	931lm	3	17.71	16	
	Efficacy	47lm/W	4	23.61	9	
TS1587	Imax=88cd/klm	Imax	234cd	5	29.51	6

	4000K	H(m)	D(m)	Emax(lx)		
	Ra80			143°		
	Fixture Power	20W	1	5.90	146	
	Source Flux	2661lm	2	11.81	36	
	Fixture Flux	939lm	3	17.71	16	
	Efficacy	47lm/W	4	23.61	9	
TS1587	Imax=88cd/klm	Imax	235cd	5	29.51	6

180° EMISSION

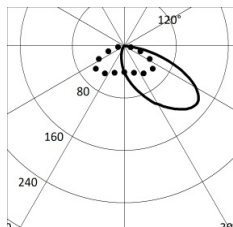
	2700K	H(m)	D1(m)	D2(m)	Emax(lx)		
	Ra80		55°	106°			
	Fixture Power	14W	1	2.65	4.33	127	
	Source Flux	1855lm	2	5.30	8.65	32	
	Fixture Flux	470lm	3	7.95	12.98	14	
	Efficacy	35lm/W	4	10.60	17.31	8	
TS1588	Imax=142cd/klm	Imax	263cd	5	13.25	21.64	5

	3000K	H(m)	D1(m)	D2(m)	Emax(lx)		
	Ra80		55°	106°			
	Fixture Power	14W	1	2.65	4.33	132	
	Source Flux	1934lm	2	5.30	8.65	33	
	Fixture Flux	490lm	3	7.95	12.98	15	
	Efficacy	36lm/W	4	10.60	17.31	8	
TS1588	Imax=142cd/klm	Imax	274cd	5	13.25	21.64	5

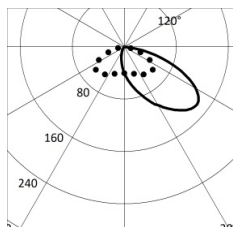
	3500K	H(m)	D1(m)	D2(m)	Emax(lx)		
	Ra80		55°	106°			
	Fixture Power	14W	1	2.65	4.33	134	
	Source Flux	1967lm	2	5.30	8.65	34	
	Fixture Flux	498lm	3	7.95	12.98	15	
	Efficacy	37lm/W	4	10.60	17.31	8	
TS1588	Imax=142cd/klm	Imax	279cd	5	13.25	21.64	5

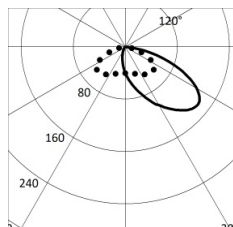
	4000K	H(m)	D1(m)	D2(m)	Emax(lx)		
	Ra80		55°	106°			
	Fixture Power	14W	1	2.65	4.33	136	
	Source Flux	1983lm	2	5.30	8.65	34	
	Fixture Flux	502lm	3	7.95	12.98	15	
	Efficacy	37lm/W	4	10.60	17.31	8	
TS1588	Imax=142cd/klm	Imax	281cd	5	13.25	21.64	5

CHIOBO

PHOTOMETRY

90° EMISSION

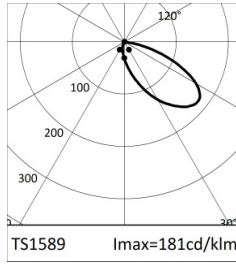

2700K		H(m)	D1(m)	D2(m)	Emax(lx)		
Ra80		49°	53°				
Fixture Power	9W	1	2.36	1.58	114		
Source Flux	1379lm	2	4.73	3.15	28		
Fixture Flux	232lm	3	7.09	4.73	13		
Efficacy	27lm/W	4	9.46	6.31	7		
TS1589	I _{max} =181cd/klm	I _{max}	250cd	5	11.82	7.88	5

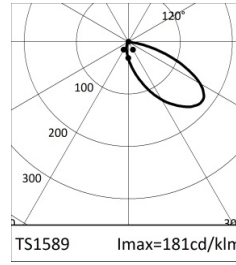

3000K		H(m)	D1(m)	D2(m)	Emax(lx)		
Ra80		49°	53°				
Fixture Power	9W	1	2.36	1.58	118		
Source Flux	1438lm	2	4.73	3.15	30		
Fixture Flux	242lm	3	7.09	4.73	13		
Efficacy	28lm/W	4	9.46	6.31	7		
TS1589	I _{max} =181cd/klm	I _{max}	260cd	5	11.82	7.88	5

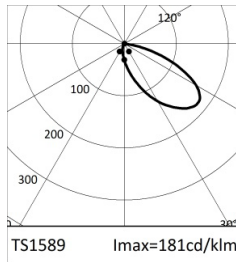

3500K		H(m)	D1(m)	D2(m)	Emax(lx)		
Ra80		49°	53°				
Fixture Power	9W	1	2.36	1.58	121		
Source Flux	1463lm	2	4.73	3.15	30		
Fixture Flux	246lm	3	7.09	4.73	13		
Efficacy	28lm/W	4	9.46	6.31	8		
TS1589	I _{max} =181cd/klm	I _{max}	265cd	5	11.82	7.88	5

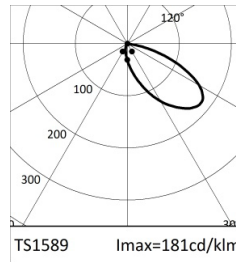

4000K		H(m)	D1(m)	D2(m)	Emax(lx)		
Ra80		49°	53°				
Fixture Power	9W	1	2.36	1.58	122		
Source Flux	1475lm	2	4.73	3.15	30		
Fixture Flux	248lm	3	7.09	4.73	14		
Efficacy	29lm/W	4	9.46	6.31	8		
TS1589	I _{max} =181cd/klm	I _{max}	267cd	5	11.82	7.88	5

90° + 90° EMISSION

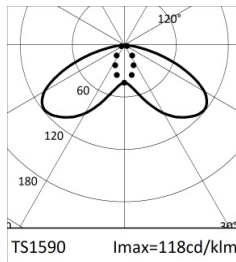

2700K		H(m)	D1(m)	D2(m)	Emax(lx)		
Ra80		54°	77°				
Fixture Power	14W	1	2.58	2.54	110		
Source Flux	1855lm	2	5.16	5.08	27		
Fixture Flux	485lm	3	7.74	7.62	12		
Efficacy	36lm/W	4	10.32	10.15	7		
TS1590	I _{max} =118cd/klm	I _{max}	219cd	5	12.90	12.69	4

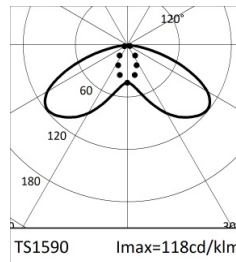

3000K		H(m)	D1(m)	D2(m)	Emax(lx)		
Ra80		54°	77°				
Fixture Power	14W	1	2.58	2.54	114		
Source Flux	1934lm	2	5.16	5.08	29		
Fixture Flux	506lm	3	7.74	7.62	13		
Efficacy	37lm/W	4	10.32	10.15	7		
TS1590	I _{max} =118cd/klm	I _{max}	228cd	5	12.90	12.69	5

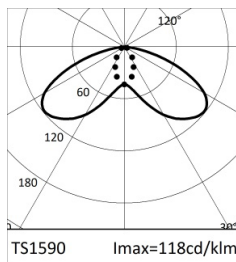

3500K		H(m)	D1(m)	D2(m)	Emax(lx)		
Ra80		54°	77°				
Fixture Power	14W	1	2.58	2.54	116		
Source Flux	1967lm	2	5.16	5.08	29		
Fixture Flux	514lm	3	7.74	7.62	13		
Efficacy	38lm/W	4	10.32	10.15	7		
TS1590	I _{max} =118cd/klm	I _{max}	232cd	5	12.90	12.69	5

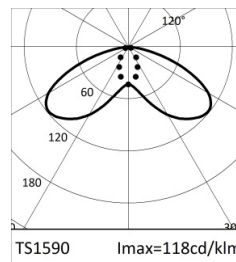

4000K		H(m)	D1(m)	D2(m)	Emax(lx)		
Ra80		54°	77°				
Fixture Power	14W	1	2.58	2.54	117		
Source Flux	1983lm	2	5.16	5.08	29		
Fixture Flux	519lm	3	7.74	7.62	13		
Efficacy	38lm/W	4	10.32	10.15	7		
TS1590	I _{max} =118cd/klm	I _{max}	234cd	5	12.90	12.69	5