

L225C-S

INTERIOR

Spotlight | For ceilings, walls

● Dry location

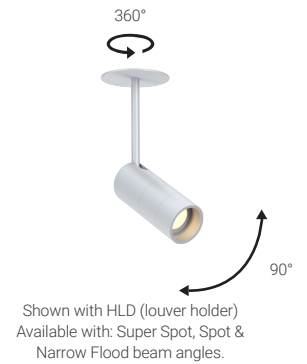
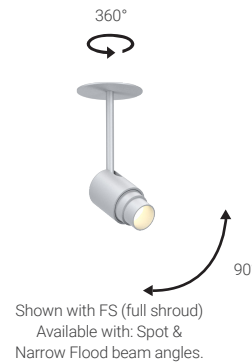
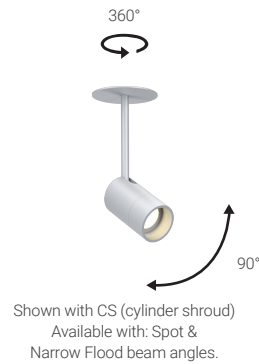

Ordering Information

Clear Form

Date : _____

Quantity : _____

Project : _____

Note : _____

Type : _____

Specifications

Luminaire | Example Code: L225-C3-N-2-W30H-N-CS-2-MA

Product	Canopy ¹	Size	Version	CCT & CRI ²	Beam Angle	Accessories-Holder ³ (optional)	Shroud	Stem Length ⁴	Finish ⁵	
L225		S								
	C1	S small	1 1W	W22S 2200K 80+	S spot 12°	HLD louver holder	FS full shroud	2 2" (51mm)	Aluminum Finishes: MA matte clear anodized BA black anodized WH white powder coat	
	C3		2 2W	W27H 2700K 90+	N narrow flood 30°		CS cylinder shroud			X custom length
	C4			W30H 3000K 90+						
	C21			W35H 3500K 90+						
	C23			W41H 4100K 90+						

System Components (Ordered Separately)

Remote Driver : _____

* Consult MP Lighting Website or Factory.

Important Notes

Specification

- See pg.3 - for different canopy options and its dimensions.
- Refer to pg.2 - Electrical for Colour Consistency details.
- HLD is required for SS (super spot, 7°) lens, louver, or other accessories supplied on site.
- Maximum: 8" (2438mm), 1" (25mm) increments
- Refer to Appendix or MP Lighting website for complete look of luminaire with different finish options. Please consult factory for custom finish for shrouds. WH not available with Super Spot beam angle.

Warranty Notes & Disclaimer

Malfunction and damage to product due to incompatible dimming system or misuse will not be covered under warranty. Consult MP Lighting for recommended drivers. If the fixture has an option to be installed with a dimming control system, consult a dimming system manufacturer with minimum load before installing. MP Lighting reserves the right, at its sole discretion, at any time and without notice, to make design changes to any of our products. Consult MP Lighting website for most updated documentation.

L225C-S

INTERIOR

Spotlight | For ceilings, walls

● Dry location

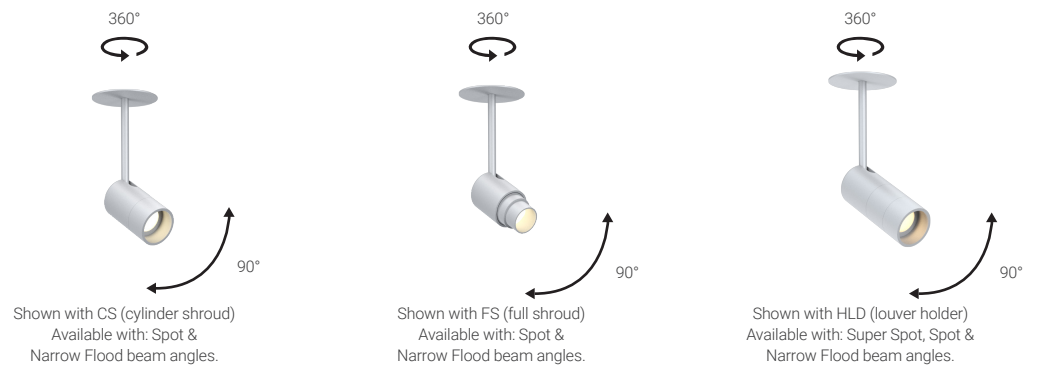

Performance

Wattage	Forward Current	Power Consumption Budget per fixture (including driver)	LED output (Source)	Fixture Output (Delivered)
1W	350mA	1.2W	110lm	65-75lm
2W	700mA	2.9W	220lm	129-149lm

Application

Environment	Dry Location approved. IP 20.
Mounting	C1/C3/C4/C23: Mounts to a 4" octagonal box using the mounting canopy C21: Mounts to a surface with coil spring clips Cut-out size: Ø1-1/2" (38mm)

Electrical

Power Supplies	Remote LED drivers (120-277V AC input, constant current output): Fixtures to be wired in series.
Control	On/off control Dimming: ELV or 0-10V dimming with appropriate drivers Other options (consult factory): TRIAC/MLV, DMX, DALI, Casambi, Power over Ethernet

Luminaire Construction

LED Light Source	W22S = CCT: 2200K, CRI (Ra): 80+, Colour Consistency: 3SDCM W27H = CCT: 2700K, CRI (Ra): 90+, Colour Consistency: 2SDCM W30H = CCT: 3000K, CRI (Ra): 90+, Colour Consistency: 2SDCM W35H = CCT: 3500K, CRI (Ra): 90+, Colour Consistency: 2SDCM W41H = CCT: 4100K, CRI (Ra): 90+, Colour Consistency: 3SDCM
Weight	N/A
Material	Fixture: machined marine-grade aluminum
Supplied with	Standard installation housing: Comes with a canopy, a universal crossbar, two hex socket head screws, two wire-nuts, and an allen key OR C21 with two wire connectors.
Warranty & LED Life	5 years limited warranty Estimated useful life of LED is 50,000 hours.

Ordered Separately

System Components	Power supplies: remote driver Please consult factory or visit Recommended Drivers for available driver options.
-------------------	---

Mounting Options & Dimensions

LED Fixture Dimensions (shown with Cylinder Shroud & C21 canopy)

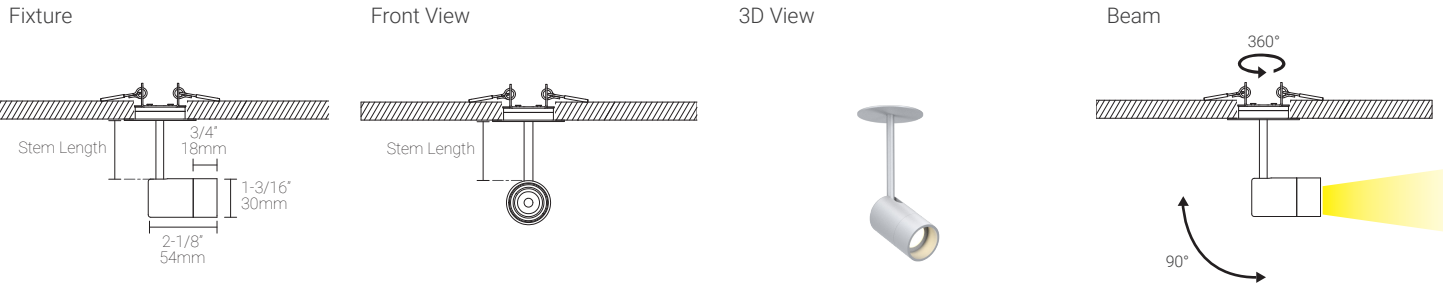

LED Fixture Dimensions (shown with Full Shroud & C21 canopy)

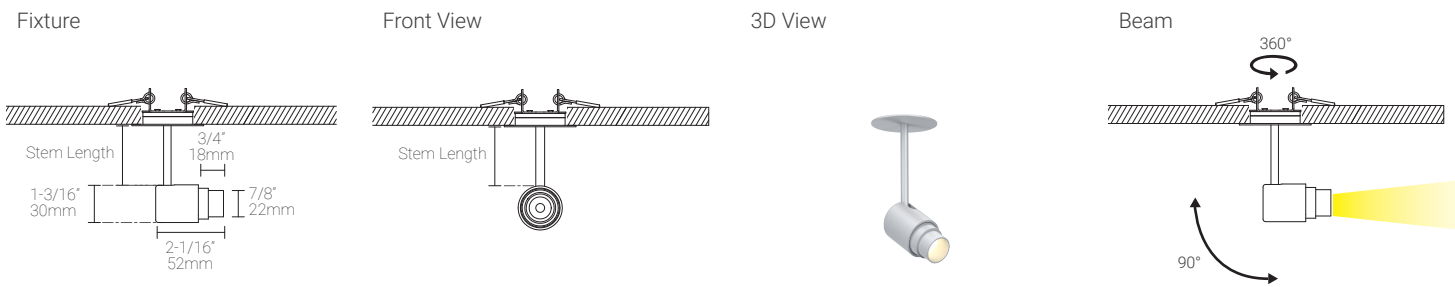

LED Fixture Dimensions (shown with HLD & C21 canopy)

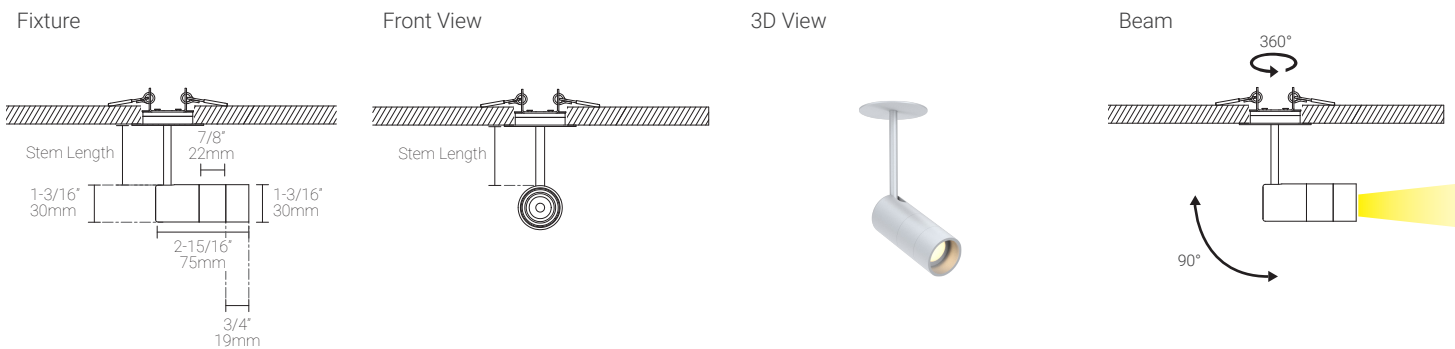

Measurement of Custom Stem Length (X)

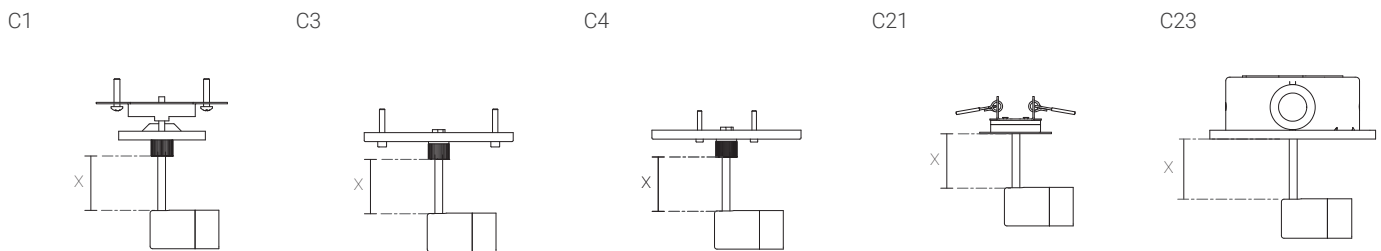

* Spotlight can rotate 360° with C21 canopy.

* Spotlight can rotate 360° with C23 canopy.

Mounting Options & Dimensions

C1



C3

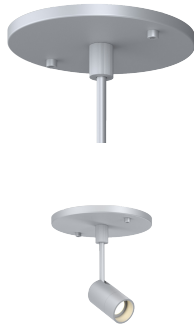

C4

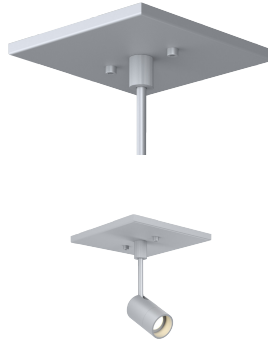

C21



C23

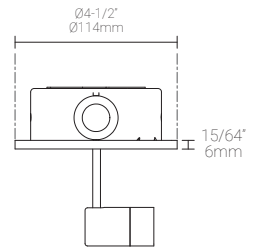
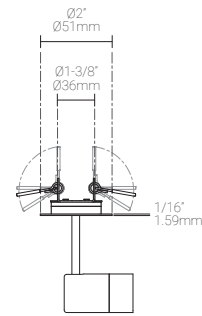
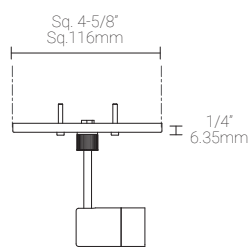
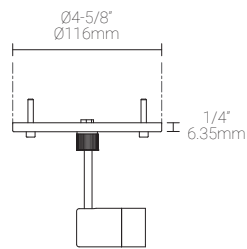
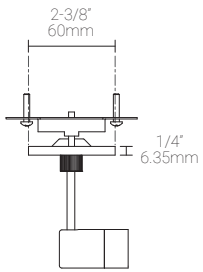
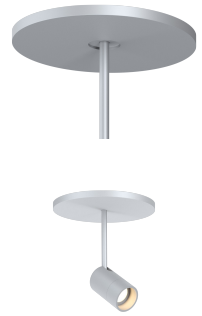

Appendix

Aluminum Finishes



MA matte clear anodized



BA black anodized



WH white powder coat

Accessories | Louver holder



MA matte clear anodized



BA black anodized

1W, 3000K, 90+ CRI

Polar Candela Distribution

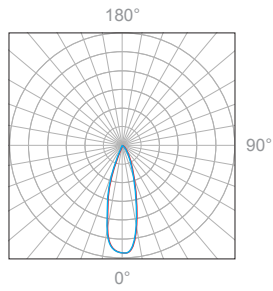

Beam Width: 12°



Illuminance at a Distance

Distance		Center Beam fc	Beam Width			
3.0ft	0.91m	50.3fc	1.0ft	0.30m	1.0ft	0.30m
6.0ft	1.83m	12.6fc	2.1ft	0.64m	2.1ft	0.64m
9.0ft	2.74m	5.5fc	3.1ft	0.94m	3.1ft	0.94m
12.0ft	3.66m	3.1fc	4.1ft	1.25m	4.1ft	1.25m
15.0ft	4.57m	2.0fc	5.2ft	1.58m	5.2ft	1.58m
18.0ft	5.49m	1.4fc	6.2ft	1.89m	6.2ft	1.89m

Delivered Lumen: 65lm
 ■ Vertical Beam Spread: 19.5°
 ■ Horizontal Beam Spread: 19.5°

Polar Candela Distribution

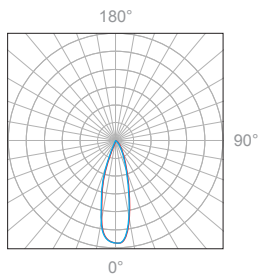

Beam Width: 30°

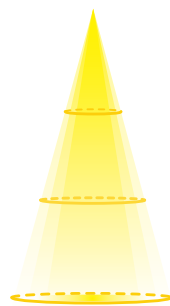

Illuminance at a Distance

Distance		Center Beam fc	Beam Width			
3.0ft	0.91m	35fc	1.4ft	0.43m	1.4ft	0.43m
6.0ft	1.83m	8.7fc	2.9ft	0.88m	2.9ft	0.88m
9.0ft	2.74m	3.9fc	4.3ft	1.31m	4.3ft	1.31m
12.0ft	3.66m	2.1fc	5.7ft	1.74m	5.7ft	1.74m
15.0ft	4.57m	1.4fc	7.2ft	2.19m	7.2ft	2.19m
18.0ft	5.49m	0.9fc	8.6ft	2.62m	8.6ft	2.62m

Delivered Lumen: 75lm
 ■ Vertical Beam Spread: 28.5°
 ■ Horizontal Beam Spread: 28.7°

2W, 3000K, 90+ CRI

Polar Candela Distribution

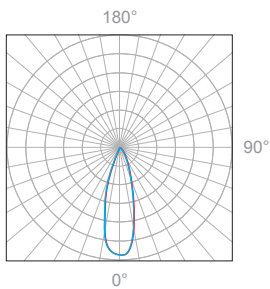

Beam Width: 12°



Illuminance at a Distance

Distance		Center Beam fc	Beam Width			
3.0ft	0.91m	103fc	1.0ft	0.30m	1.0ft	0.30m
6.0ft	1.83m	25.9fc	2.0ft	0.60m	2.0ft	0.60m
9.0ft	2.74m	11.5fc	3.0ft	0.91m	3.0ft	0.91m
12.0ft	3.66m	6.47fc	4.0ft	1.22m	4.0ft	1.22m
15.0ft	4.57m	4.14fc	5.0ft	1.52m	5.0ft	1.52m
18.0ft	5.49m	1.87fc	6.0ft	1.83m	6.0ft	1.83m

Delivered Lumen: 129lm
 ■ Vertical Beam Spread: 19°
 ■ Horizontal Beam Spread: 19°

Polar Candela Distribution

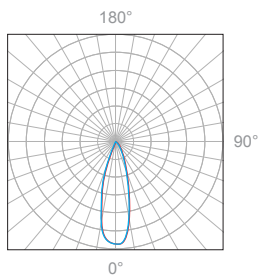

Beam Width: 30°

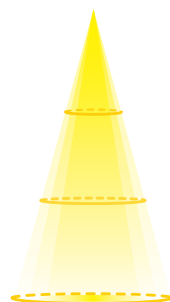

Illuminance at a Distance

Distance		Center Beam fc	Beam Width			
3.0ft	0.91m	69.5fc	1.5ft	0.46m	1.5ft	0.46m
6.0ft	1.83m	17.4fc	3.0ft	0.91m	3.0ft	0.91m
9.0ft	2.74m	7.73fc	4.5ft	1.37m	4.5ft	1.37m
12.0ft	3.66m	4.35fc	6.0ft	1.83m	6.0ft	1.83m
15.0ft	4.57m	2.78fc	7.6ft	2.32m	7.6ft	2.32m
18.0ft	5.49m	1.93fc	9.1ft	2.77m	9.1ft	2.77m

Delivered Lumen: 149lm
 ■ Vertical Beam Spread: 28.3°
 ■ Horizontal Beam Spread: 28.3°