

# ID+ 2.5"

OVERLAP & TRIMLESS LED DOWNLIGHTS

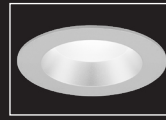

FOCAL POINT®



Solite lens



Clear diffuse

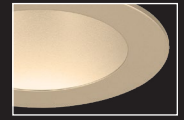

Warm diffuse

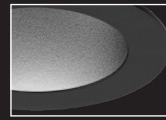

Black



White



Optional painted flanges



Wall Wash companion

## DIMENSIONAL DATA

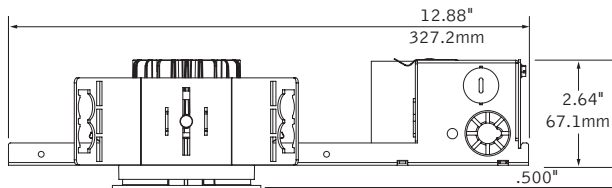

Field adjustability of ceiling thickness from 0.5" - 1.5"  
Housing height with DALI, Lutron & LZ1 drivers is 3.0"

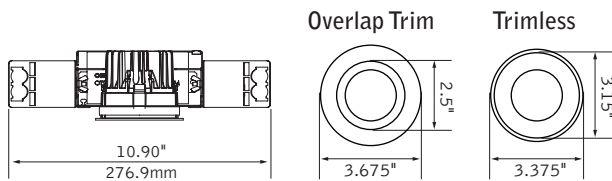

## FEATURES

Less than 2.64" low profile housing available.

60° and 75° cut-off reflector options available.

25° to 90° beam spreads support accent lighting, task lighting and general illumination

Solite lens with die-cast trim delivers 70° or 90° beam spread options.

Warm Dim: Lighting that enhances spaces with a warm glow, reminiscent of incandescent or halogen light sources.

PoE compatible: Integrates with Power over Ethernet lighting systems via standard, low-voltage wires.

Configurations available for Title 24 JA8 High Efficacy Lighting compliance.

## DISTRIBUTIONS

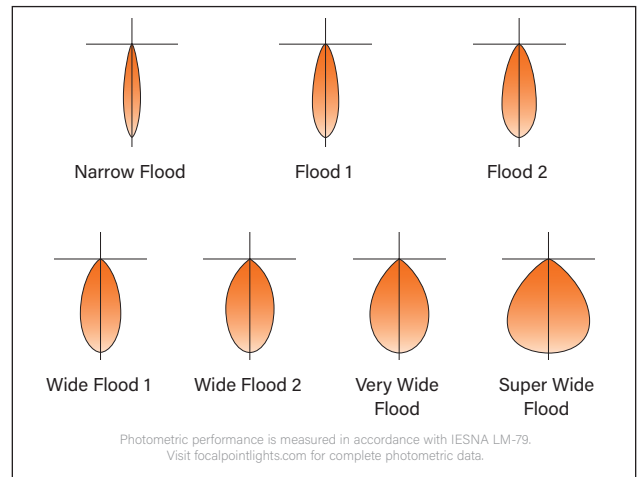

Photometric performance is measured in accordance with IESNA LM-79.  
Visit [focalpointlights.com](http://focalpointlights.com) for complete photometric data.

fixture:

project:

**HOUSING DETAILS**

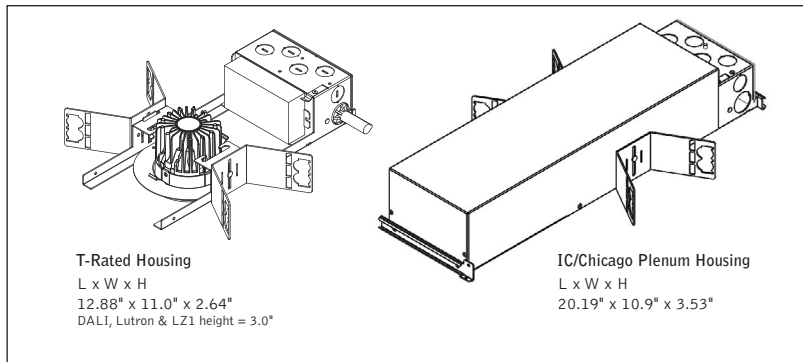

**HOUSING SPECIFICATIONS**

**Construction**

Thermally protected housing for new construction applications. Insulation to be kept 3" away from housing. Type IC inherently protected, suitable for direct contact with insulation. Restrictive airflow per ASTM-E283. LC2AT trim is inherently airtight and may be used to obtain airtight rating when used with IC-rated or thermally protected, non-IC (T) housings. Butterfly brackets allow mounting to 1/2" emt. Order bar hangers as an accessory. Die-cast aluminum heat sink designed for maximum thermal dissipation. Die-formed housing and integral junction box with (7) 1/2" pry outs. Accommodates ceiling thicknesses up to 0.5" standard, field adjustable up to 1.5" thickness. For thicker ceiling consult factory. Fixture will not exceed 5 lb.

**Electrical**

Choice of constant current dimming drivers. Power factor > .9 typical. PoE compatible: Integrates with Power over Ethernet lighting systems via standard, low-voltage wires.

**Emergency**

Above ceiling access required, overlap trim only. Emergency output - 7W for 90 minutes. Maximum mounting height: Clear Diffuse & White: 17.2ft. Black & Warm Diffuse: 15.5ft.

**Labels**

UL and cUL Listed. Suitable for Dry, Damp or Wet Locations, indoor use only. Specify Outdoor rated (OD) for outdoor recessed ceiling applications. Configurations available for Title 24 JA8 compliance, consult the JA8 High Efficacy Lighting Reference Guide for options. JA8 factory option must be specified to ensure Title 24 JA8 compliance.

**Lumen Maintenance**

Reported: L70 at >55,000 hours      Calculated: L70 at 204,000 hours  
L90 at >55,000 hours                      L90 at 59,000 hours

Derived from EPA TM-21 calculator. Based on typical conditions, consult factory for additional data.

**Reliability**

At Focal Point, our products are designed to stand the test of time. Each luminaire is engineered using superior components, manufactured with the utmost care and rigorously tested. Contact us for reliability data.

**Warranty**

LED System rated for operation in ambient environments up to 25°C. 5-year limited warranty. Fixture with Outdoor rated option must be installed in a covered ceiling and is warranted for operation in ambient environments between -20°C to +40°C.

**TRIM & LED SPECIFICATIONS**

**LED System**

Proprietary array incorporates premium LEDs on a robust platform. May be specified in 2700K, 3000K, 3500K or 4000K, or Warm Dimming (2700K-1800K and 3000K-1800K), CRI>80, >90 or 97. Color accuracy within 2 SDCM (Warm Dimming from 3-5 SDCM). Aluminum heat sink provides appropriate thermal management.

**Aesthetics**

Die-cast aluminum trims. Overlap trims are self-flanged.

**Optics**

60-degree or 75-degree cut-off to light source and its image.

Optic	Cut-Off Degree	Trim Type	Distribution Beam Spread					Spacing Criteria	
			NFL	FL1	FL2	WFL1	WFL2	VWFL	SWFL
DNS	60°	Overlap	20°   0.36	33°   0.54	42°   0.68	52°   0.80	64°   0.92	-	-
		Trimless	21°   0.38	33°   0.54	43°   0.68	51°   0.78	62°   0.88	-	-
DSS	75°	Overlap	-	-	-	52°   0.86	61°   0.88	70°   1.02	81°   1.14
		Trimless	-	-	-	52°   0.84	65°   0.90	69°   0.98	89°   1.26

**PERFORMANCE TABLE** - see page 3.

Focal Point LLC reserves the right to change specifications for product improvement without notification.

**HOUSING ORDERING**

<b>Housing Series</b>	ID+ 2.5" Round	FLC2D
<b>Trim Type</b>	Round Overlap	RDO
	Round Trimless	RDT
<b>Color Options</b>	Standard White, 80 & 90 CRI	SW
	High 97 CRI	HC
	Warm Dim	WDM
<small>(900L only. UNV, LV &amp; EMR not available.)</small>		
<b>Lumen Output</b>	500 Lumen (L1, LD1 & LVN only)	500L
	700 Lumen (Not available with LFP, LTE or LH1)	700L
	900 Lumen (Not available with LFP or LH1)	900L
	1100 Lumen	1100L
	1300 Lumen	1300L
	1500 Lumen	1500L
	1700 Lumen	1700L
	1900 Lumen (L1, LD1 & LH1 only)	1900L
<b>Voltage</b>	120/277 Volt	UNV
<small>(IC housing: SW &amp; HC: 1500L max. T &amp; TW housings: SW 1100L max., HC: 900L max.)</small>		
	120V	120
	277V	277
<b>Low Voltage</b>	LV	LV
<small>(IC housing: SW &amp; HC: 1500L max. T &amp; TW housings: SW 1100L max., HC: 900L max.)</small>		
<b>Control System &amp; Dimming Level</b>	0-10V <1% Dimming	LZ1
	0-10V - 1% Dimming	L11
	0-10V - 10% Dimming	LD1
<b>Low Voltage, PoE Compatible</b>	LVN	LVN
<small>(No driver. Not available with EMR, LV voltage only.)</small>		
	Forward Phase (120V only)	LFP
	Lutron Hi-Lume EcoSystem (LDE1) - 1% Dimming	LH1
	Lutron Hi-Lume - Forward Phase (120V) - 1% Dimming	LTE
	DALI <1% Dimming	DZ1
	DALI - 1% Dimming	D11
<b>Housing Type</b>	IC Rated / Airtight (1500L max.)	IC
	Thermally Protected, Non-IC	T
	Thermally Protected, Non-IC Wood	TW
<small>(Trimless only. Wood kit required.)</small>		
<b>Factory Options</b>	Bar Hangers	BH
	Chicago Plenum	CP
	Emergency Battery -Remote test switch	EMR
<small>(Overlap trim &amp; T Housing only. Above ceiling access.)</small>		
	Outdoor Rated	OD
<small>(LD1 driver and T-rated housing only. Not available with CP or EMR. See dimming performance table on page 3.)</small>		
	Title 24 / JA8 Compliant	JA8
<small>(Consult JA8 Reference Guide for available options.)</small>		
<b>TRIM &amp; LED MODULE</b>		
<b>Aperture</b>	2.5" Round Reflector	LC2
	2.5" Round Airtight Reflector	LC2AT
<b>Trim Type</b>	Round Overlap	RDO
	Round Trimless	RDT
<b>Lumen Output</b>		
<small>Trim &amp; housing output must match. See options above.</small>		
<b>Color Temperature</b>		
<small>(Add 9 for 90 CRI or H for 97 CRI. Leave blank for 80 CRI. Examples: 2700K, 97 CRI = H27K. 2700K, 80 CRI = 27K.)</small>		
	2700K, 80/90/97+ CRI	_27K
	3000K, 80/90/97+ CRI	_30K
	3500K, 80/90/97+ CRI	_35K
	4000K, 80/90/97+ CRI	_40K
	Warm Dim: 2700-1800K, 90+ CRI	92718W
	Warm Dim: 3000-1800K, 90+ CRI	93018W
<b>Optic</b>	Short Cone with 60° cut-off	DNS
	Super Short Cone with Solite Lens 75° cut-off	DSS
<b>Distribution</b>	Narrow Flood (DNS only)	NFL
	Flood (DNS only)	FL1
	Flood (DNS only)	FL2
	Wide Flood	WFL1
	Wide Flood	WFL2
	Very Wide Flood (DSS only)	VWFL
	Super Wide Flood (DSS only)	SWFL
<b>Finish</b>	Clear Diffuse	CD
	Warm Diffuse	WD
	Black	BK
	White	WH
<b>Optional Flange Finish</b>		
<small>(Overlap CD &amp; WD finish only. For matching finishes leave blank.)</small>		
	Black Painted	BP
	White Painted	WP
<b>Factory Options</b>	Title 24 / JA8 Compliant (Trim & housing must match)	JA8
<b>ACCESSORIES</b>	Trimless Wood Ceiling Installation Kit	LC2- WOOD-KIT
<small>(One kit recommended per 10 downlights)</small>		

**2.5" ROUND DOWNLIGHT PERFORMANCE TABLE**

Lumen Output	Delivered Lumens	System Watts	LPW
500L	513	6	86
700L	756	8.2	92
 900L	880	14.6	60
900L	929	9.9	94
1100L	1139	11.9	96
1300L	1354	16.2	84
1500L	1527	18.1	84
1700L	1746	20.7	84
1900L	1949	23.3	84

Based on Overlap, Short cone, 3500K, 80 CRI, Flood 2, Clear Diffuse. WDM based on 3000 - 1800K, 90 CRI. Delivered lumen output may vary +/- 5%. Actual wattage may vary +/- 5%

**OUTDOOR RATED (OD) DRIVER DIMMING PERFORMANCE TABLE**

Lumen Output	Minimum Dimming Level
500L	25%
700L	17%
900L	13%
1100L	10%
1300L	10%
1500L	10%
1700L	10%
1900L	10%

**2.5" ROUND DOWNLIGHT LUMEN MULTIPLIER TABLE**

**Color Temperature & CRI**

Trim Type	Optic	Color Temperature & CRI	Multiplier
ALL	ALL	2700K 80+ CRI [27K]	0.92
		2700K 90+ CRI [927K]	0.79
		2700K 97 CRI [H27K]	0.67
		3000K 80+ CRI [30K]	0.98
		3000K 90+ CRI [930K]	0.83
		3000K 97 CRI [H30K]	0.72
		3500K 80+ CRI [35K]	1.00
		3500K 90+ CRI [935K]	0.82
		3500K 97 CRI [H35K]	0.73
		4000K 80+ CRI [40K]	1.01
		4000K 90+ CRI [940K]	0.84
		4000K 97 CRI [H40K]	0.76
2700-1800K 90+ CRI [92718K]	0.93		
3000-1800K 90+ CRI [93018K]	0.98		

**Distribution**

Trim Type	Optic	Distribution	Multiplier
Round Trimless [RDT]	Short Cone with 60° cut-off [DNS]	Narrow Flood [NFL]	1.05
		Flood 1 [FL1]	0.99
		Flood 2 [FL2]	1.03
		Wide Flood 1 [WFL1]	1.00
		Wide Flood 2 [WFL2]	0.91
	Super Short Cone with Solite Lens with 75° cut-off [DSS]	Wide Flood 1 [WFL1]	1.07
		Wide Flood 2 [WFL2]	0.82
		Very Wide Flood [VWFL]	0.85
		Super Wide Flood [SWFL]	0.75
		Round Overlap [RDO]	Short Cone with 60° cut-off [DNS]
Flood 1 [FL1]	0.99		
Flood 2 [FL2]	1.03		
Wide Flood 1 [WFL1]	1.00		
Wide Flood 2 [WFL2]	0.91		
Super Short Cone with Solite Lens with 75° cut-off [DSS]	Wide Flood 1 [WFL1]		1.07
	Wide Flood 2 [WFL2]		0.82
	Very Wide Flood [VWFL]		0.85
	Super Wide Flood [SWFL]		0.75

**How To Use Lumen Multipliers**

**Formula:**  
 (Lumen Output Value) x  
 (Color Temperature & CRI) x  
 (Distribution) x  
 (Color)

**Example:**  
 LC2-RDO-SW-1100L-935K-DNS-FL1-WH

(1100) x (0.83) x (0.99) x (1.08) ≈ 976lm  
 (estimated delivered lumens)

**Color**

Trim Type	Optic	Color	Multiplier
ALL	Short Cone with 60° cut-off [DNS]	Clear Diffuse [CD]	1.00
		Warm Diffuse [WD]	0.99
		White [WH]	1.08
		Black [BK]	0.90
	Super Short Cone with Solite Lens with 75° cut-off [DSS]	Clear Diffuse [CD]	1.00
		Warm Diffuse [WD]	0.98
		White [WH]	1.08
		Black [BK]	0.90

Multiplier charts are provided to aid with estimation of lumen levels across options. Apply multipliers against ordered Lumen Output to estimate Delivered Lumens. An estimation should make use of all tables through consecutive application of three multipliers. Refer to IES files for most accurate photometric information.