

Linear

MiMi Glow A010 (10W) Fixture Guide

KKDÖ

Indoor/Outdoor | Surface | Low output up to 420lm/m (128lm/ft)

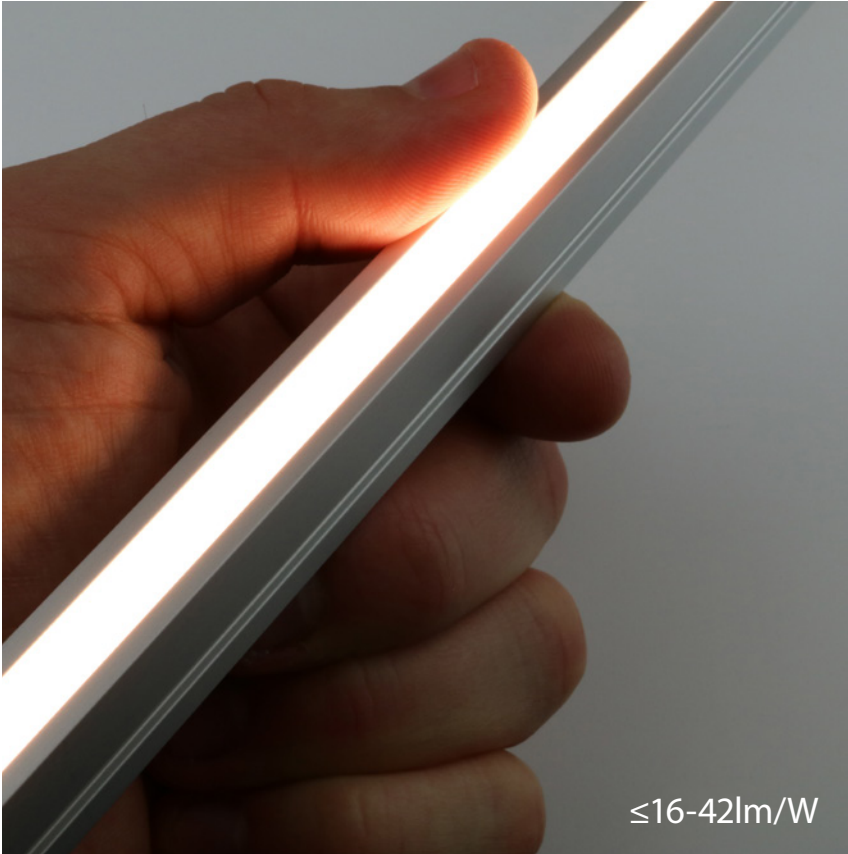

≤16-42lm/W



Key applications

- ✓ Architectural detail
- ✓ Bathrooms
- ✓ Cove lighting
- ✓ Handrail
- ✓ Interior/Exterior
- ✓ Indirect lighting
- ✓ Mirror back lighting
- ✓ Shelving display
- ✓ Under bench

Key features

- ✓ Custom lengths
- ✓ Decorative
- ✓ Diffusion: Homogenous
- ✓ Direct view
- ✓ Extensive CCT range
- ✓ Form factor: Small
- ✓ High lumen efficacy
- ✓ IP54
- ✓ IP67
- ✓ Output low

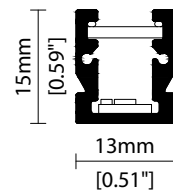

MOUNTING METHODS



KKCP-14 Lock clip



KKBK-24 Adjustable bracket



EB End Cap Bracket

Linear

MiMi Glow A010 (10W)

Specification sheet



Dimension	H15/W13/L97-2020mm* (H0.59/W0.51/L3.82-79.53in*) *Nano Louvre = 1020mm/40.16in Max
PCB increment	38.46mm increment/2000mm* (1.51in increment/78.74in*) *Nano Louvre = 1000mm/39.37in Max
LED pitch	4.8mm - 208LED/m (0.19in - 64LED/ft)
Chip	A-line
Beam angle	86° (Diffused Cover)/35° (Nano Louvre)
Colours	A-line 2700K/3000K/4000K
Bin/Step	A-line 3-step MacAdam ellipse
CRI	94
Lifetime	50,000 hours @ 25°C (50,000 hours @ 77°F)
Operating temp	T _a = -25 to 50°C (T _c max = 74.9°C) T _a = -13 to 122°F (T _c max = 166.82°F)
IP rating	IP54/IP67
Finish	Silver anodised
Cover/lens	Diffused/Diffused + Nano Louvre
Mounting	Surface mounting lock clip or adjustable bracket
Power feed	Sheathed hardwire tails or male/female connectors
Control	0-10V/1-10V/DMX/DALI



LED Grading Key

Exclusive Grade *KKDC tuned CCT range

A-line* 3-step CCT range

KKDC highest lumen efficacy LED

PERFORMANCE DATA @ 3000K

Power Consumption	Supply voltage	Supply current
10W/m (3.05W/ft)	24V DC	0.42A/m (0.13A/ft)

Colour Rendering Index (CRI)

A-line	R1	R2	R3	R4	R5	R6	R7	R8	R9	R10	R11	R12	R13	R14
	95	97	98	94	94	96	94	86	68	92	94	78	96	98

	Diffused	Diffused + Nano Louvre	CRI	R9	Rf	Rg
A-line	420lm/m (128lm/ft) 42lm/W	160lm/m (49lm/ft) 16lm/W	94	68	-	-

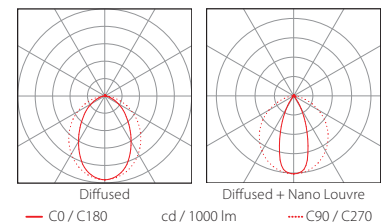
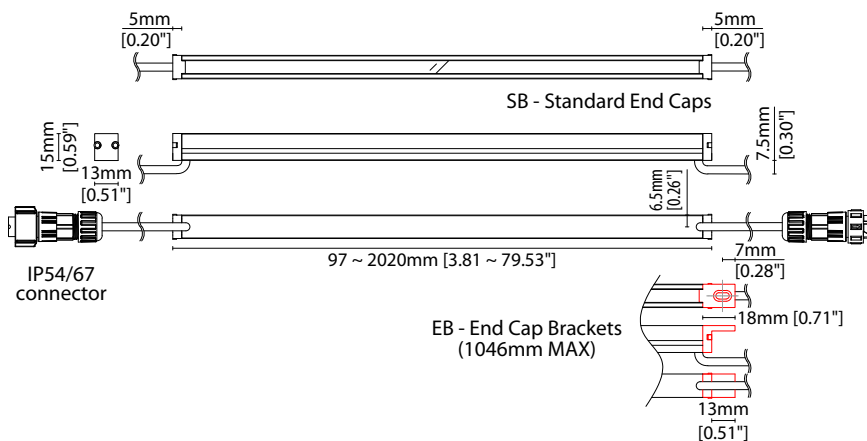

Data derived from independent UKAS / IESNA LM-79-08 accredited testing of production samples.

Linear

MiMi Glow A010 (10W) Code Table



FIXTURE

Model	Finish	Cover ¹	Grade ²	LED	Colour (CCT)	Length Availability ³	IP	Cable Length	Power Feed ⁴	Fixing	Input
MiMi Glow	MG Silver Anodised	SA Diffused Diffused + Nano Louvre ⁵	C CN	A A	010	2700K 27 3000K 30 4000K 40 m 97-2020mm 38.46mm increments i 3.82-79.53in 1.51in increments (Specify length code OR total run length)	IP54 54 IP67 ⁶ 67	300mm/ 11.81" 0300	Single ø4.3mm sheath tail S00A Double ø4.3mm sheath tail D00A Single ø4.3mm sheath IP67 connector ⁷ S67A Double ø4.3mm sheath IP67 connector ⁷ D67A	Standard End Cap SB End Cap Bracket EB	DC 24V g

- ¹ Refer to **Cover Options** on **Options** pages ² Refer to **LED Grading Key** on **Specification sheet** page ³ Refer to **Length Availability List** or enter total run length instead of length code
⁴ Refer to **Power Feed Options** on **Options** pages ⁵ Max length available with Nano Louvre is 1020mm ⁶ Due to the clear, flush potted polyurethane top layer on IP67 MiMi Glow a colour shift of +/-20K should be expected
⁷ IP67 connectors are used for both IP67 and IP54 product housings

Code Example:

MG	-	SA	-	CN	-	A	-	010	-	30	-	m	520	-	54	-	0300	-	S00A	-	EB	-	g
MiMi Glow		Silver Anodised		Diffused + Nano Louvre		A		010		3000K		520mm		IP54		300mm/11.81"		Single ø4.3mm sheath tail		End Cap Bracket		DC 24V	

ACCESSORIES

Mounting Accessories

KKCP-14	Lock Clip
KKBK-24	Adjustable bracket

* Refer to **Mounting accessories** on **Accessories** pages

Connection Accessories

CN67-2P-0300	IP67 2 PIN male & female 300mm/11.81" pair
CN67-2P-1000	IP67 2 PIN male & female 1000mm/39.37" pair
CN67-2P-3000	IP67 2 PIN male & female 3000mm/118.11" pair

* Refer to **Power feed** on **Accessories** pages

Exterior Junction Boxes

KKJB-07	IP67 Slim J-Box
KKJB-07R	Potting Resin for IP67 Slim J-Box

* Refer to **Exterior Junction Boxes** on **Accessories** pages

PSU/Driver

0-10V/1-10V/DALI/DMX

* Refer to **Driver/PSU Options** page for details or provide requirement and KKDC to offer the suitable option

LED ENGINE VARIANTS (LED STRIP TYPE)

Colour	Output	LED	Lumen/m	Lumen/ft	W/m	W/ft	Spec Doc	Length	Increment
Single CCT	Low	010	420	128	10	3.05	MiMi Glow A010	97-2020mm (3.82-79.53in)	38.46 (1.51in)
	Mid	008	583	177	20	6.09	MiMi Glow 008	103.3-2020mm (4.07-79.53in)	41.7mm (1.64in)
	Mid	020	840	256	20	6.1	MiMi Glow A020	97-2020mm (3.82-79.53in)	38.46 (1.51in)

* Performance data: A/k-line, diffused cover, 3000K

Linear

MiMi Glow A010 (10W) Length Availability List



Length Code		Fixture Length ¹		LED Strip ²		End Cap Dimension ³		Wattage (W)	Output (lm)
Metric	Imperial(US)	Metric	Imperial(US)	Metric	Imperial(US)	Metric	Imperial(US)		3000K (Test Data)
m0097	i0003	97mm	3.82in	77mm	3.03in	10mm	0.39in	0.77	32
m0135	i0005	135mm	5.33in	115mm	4.54in	10mm	0.39in	1.15	48
m0174	i0006	174mm	6.84in	154mm	6.06in	10mm	0.39in	1.54	65
m0212	i0008	212mm	8.36in	192mm	7.57in	10mm	0.39in	1.92	81
m0251	i0010	251mm	9.87in	231mm	9.09in	10mm	0.39in	2.31	97
m0289	i0011	289mm	11.39in	269mm	10.60in	10mm	0.39in	2.69	113
m0328	i0013	328mm	12.90in	308mm	12.11in	10mm	0.39in	3.08	129
m0366	i0014	366mm	14.42in	346mm	13.63in	10mm	0.39in	3.46	145
m0405	i0016	405mm	15.93in	385mm	15.14in	10mm	0.39in	3.85	162
m0443	i0017	443mm	17.44in	423mm	16.66in	10mm	0.39in	4.23	178
m0482	i0019	482mm	18.96in	462mm	18.17in	10mm	0.39in	4.62	194
m0520	i0020	520mm	20.47in	500mm	19.68in	10mm	0.39in	5.00	210
m0558	i0022	558mm	21.99in	538mm	21.20in	10mm	0.39in	5.38	226
m0597	i0023	597mm	23.50in	577mm	22.71in	10mm	0.39in	5.77	242
m0635	i0025	635mm	25.01in	615mm	24.23in	10mm	0.39in	6.15	258
m0674	i0026	674mm	26.53in	654mm	25.74in	10mm	0.39in	6.54	275
m0712	i0028	712mm	28.04in	692mm	27.26in	10mm	0.39in	6.92	291
m0751	i0029	751mm	29.56in	731mm	28.77in	10mm	0.39in	7.31	307
m0789	i0031	789mm	31.07in	769mm	30.28in	10mm	0.39in	7.69	323
m0828	i0032	828mm	32.59in	808mm	31.80in	10mm	0.39in	8.08	339
m0866	i0034	866mm	34.10in	846mm	33.31in	10mm	0.39in	8.46	355
m0905	i0035	905mm	35.61in	885mm	34.83in	10mm	0.39in	8.85	372
m0943	i0037	943mm	37.13in	923mm	36.34in	10mm	0.39in	9.23	388
m0982	i0038	982mm	38.64in	962mm	37.85in	10mm	0.39in	9.62	404
m1020	i0040	1020mm	40.16in	1000mm	39.37in	10mm	0.39in	10.00	420
m1058	i0041	1058mm	41.67in	1038mm	40.88in	10mm	0.39in	10.38	436
m1097	i0043	1097mm	43.18in	1077mm	42.40in	10mm	0.39in	10.77	452
m1135	i0044	1135mm	44.70in	1115mm	43.91in	10mm	0.39in	11.15	468
m1174	i0046	1174mm	46.21in	1154mm	45.43in	10mm	0.39in	11.54	485
m1212	i0047	1212mm	47.73in	1192mm	46.94in	10mm	0.39in	11.92	501
m1251	i0049	1251mm	49.24in	1231mm	48.45in	10mm	0.39in	12.31	517
m1289	i0050	1289mm	50.76in	1269mm	49.97in	10mm	0.39in	12.69	533
m1328	i0052	1328mm	52.27in	1308mm	51.48in	10mm	0.39in	13.08	549
m1366	i0053	1366mm	53.78in	1346mm	53.00in	10mm	0.39in	13.46	565
m1405	i0055	1405mm	55.30in	1385mm	54.51in	10mm	0.39in	13.85	582
m1443	i0056	1443mm	56.81in	1423mm	56.02in	10mm	0.39in	14.23	598
m1481	i0058	1481mm	58.33in	1461mm	57.54in	10mm	0.39in	14.61	614
m1520	i0059	1520mm	59.84in	1500mm	59.05in	10mm	0.39in	15.00	630
m1558	i0061	1558mm	61.35in	1538mm	60.57in	10mm	0.39in	15.38	646
m1597	i0063	1597mm	62.87in	1577mm	62.08in	10mm	0.39in	15.77	662
m1635	i0064	1635mm	64.38in	1615mm	63.60in	10mm	0.39in	16.15	678
m1674	i0066	1674mm	65.90in	1654mm	65.11in	10mm	0.39in	16.54	695
m1712	i0067	1712mm	67.41in	1692mm	66.62in	10mm	0.39in	16.92	711

MiMi Glow A010 (10W)

Length Availability List



Length Code		Fixture Length ¹		LED Strip ²		End Cap Dimension ³		Wattage (W)	Output (lm) 3000K (Test Data)
Metric	Imperial(US)	Metric	Imperial(US)	Metric	Imperial(US)	Metric	Imperial(US)		
m1751	i0069	1751mm	68.93in	1731mm	68.14in	10mm	0.39in	17.31	727
m1789	i0070	1789mm	70.44in	1769mm	69.65in	10mm	0.39in	17.69	743
m1828	i0072	1828mm	71.95in	1808mm	71.17in	10mm	0.39in	18.08	759
m1866	i0073	1866mm	73.47in	1846mm	72.68in	10mm	0.39in	18.46	775
m1905	i0075	1905mm	74.98in	1885mm	74.19in	10mm	0.39in	18.85	792
m1943	i0076	1943mm	76.50in	1923mm	75.71in	10mm	0.39in	19.23	808
m1981	i0078	1981mm	78.01in	1961mm	77.22in	10mm	0.39in	19.61	824
m2020	i0079	2020mm	79.52in	2000mm	78.74in	10mm	0.39in	20.00	840

¹ Actual total overall length of light fixture (LED strip + end caps + void/wire hole)

² Actual length of PCB strip

³ Actual length of 2x end caps

Standard End Caps (SB)

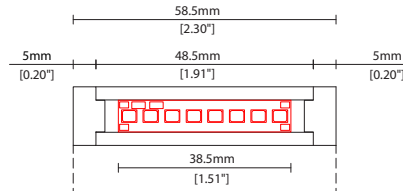

*End Cap Brackets (EB)
Increases overall standard
length by 26mm (2x13mm)

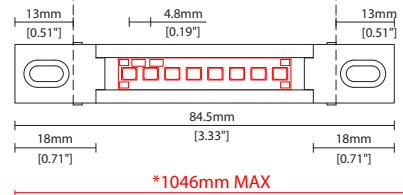

***IMPORTANT NOTE:**
DUE TO POTENTIAL PROFILE 'SAGGING' THE MAX
LENGTH AVAILABLE WITH END CAP BRACKETS IS 1046mm.

Linear

MiMi Glow A010 (10W) Options

KKDC

COVER/LENS OPTIONS

* Options are an integral part of the fixture ordering codes. Please refer to **Code Table** pages.

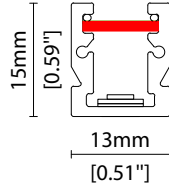
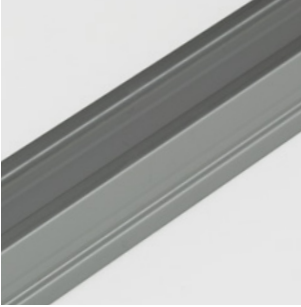

C Diffused Cover
Polycarbonate finish
W13/H15mm (W0.51"/H0.59")

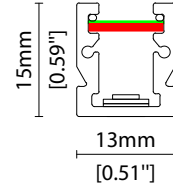
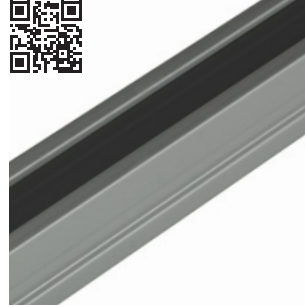

CN Diffused Cover + Nano Louvre
Polycarbonate cover with anti-glare, 30° cut-off view angle
W13/H15mm (W0.51"/H0.59")

END CAP OPTION

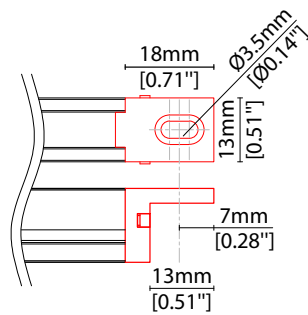

EB End Cap Bracket (Pair)
Handrail installation
Compatible up to 1m/40"
L18/W13/H15mm
(L0.7/W0.51/H0.59")

Key

Control Gear Power supply, sub-controllers & control systems
JB Junction box / cable connection

POWER FEED OPTIONS

0300 S00A 300mm (11.81") Single \varnothing 4.3mm sheath tail

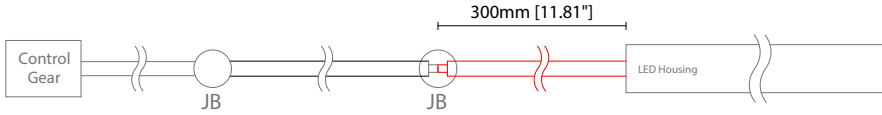

0300 D00A 300mm (11.81") Double \varnothing 4.3mm sheath tail

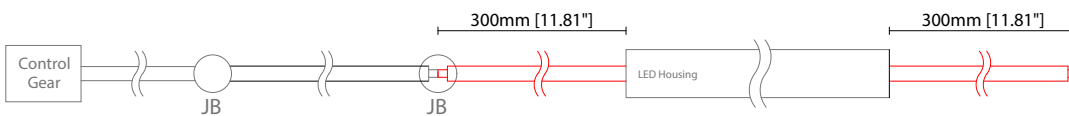

0300 S67A 300mm (11.81") Single \varnothing 4.3mm sheath IP67 connector

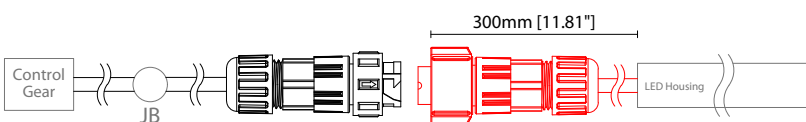

0300 D67A 300mm (11.81") Double \varnothing 4.3mm sheath IP67 connector

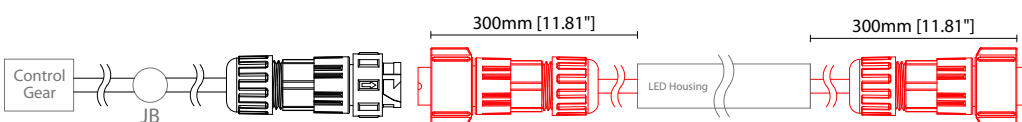

IP67 2 Pin Connector

Female connector
2 PIN (IP67)

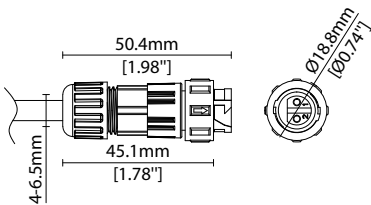

Male connector
2 PIN (IP67)

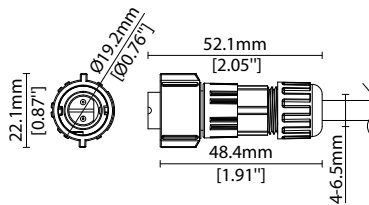

Linear

MiMi Glow A010 (10W) Accessories

KKDÖ

MOUNTING ACCESSORIES

Note: Accessories are to be ordered separately with corresponding code shown below.



KKCP-14

Lock clip (allow 2 per metre/40in)
S/Steel finish

L25/W13.6/H20.2mm
(L0.98/W0.54/H0.80")

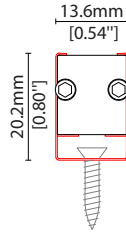

KKBK-24

Adjustable bracket
(allow 2 per metre/40in)
S/Steel finish

L36.5/W13/H41.7mm
(L1.44/W0.51/H1.64")

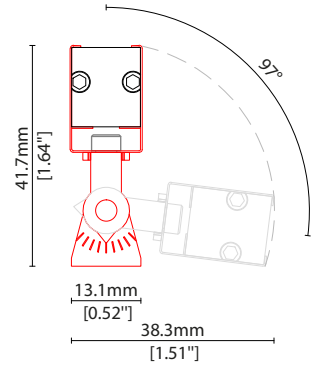

POWER FEED



CN67-2P-0300 300mm (11.81in) pair
CN67-2P-1000 1000mm (39.37in) pair
CN67-2P-3000 3000mm (118.11in) pair

IP67

2 PIN male + female connector set

EXTERIOR JUNCTION BOXES



KKJB-07

IP67 Slim J-Box
(including type A,B,C, D bushings)



KKJB-07R

Potting resin for IP67 Slim J-Box

Linear

MiMi Glow A010 (10W) Accessories

KKDC

KKDC CONTROL



IP20
Plastic housing
L170/W59/H29mm
(L6.69/W2.32/H1.14in)

KKDM-06 1-10V

visDIM dimmable sub-controller
(4 x 8A max @ 12-36V)



IP20
Plastic housing
L170/W53.4/H28mm
(L6.69/W2.10/H1.10in)

KKSC-05 DMX

visDIM dimmable sub-controller
(4 x 5A max @ 12-36V)



IP20
Plastic housing
L170/W59/H29mm
(L6.69/W2.32/H1.14in)

KKDL-02 DALI

visDIM dimmable sub-controller
(4 x 8A max @ 12-36V)



IP20
Plastic housing
L166/W53.4/H23mm
(L6.54/W2.10/H0.91in)

KKDL-03 DALI

visDIM dimmable sub-controller
(4 x 5A max @ 12-36V)

AVAILABLE PSU OPTIONS

Control Mode	PSU (Order Code)	Input Voltage AC	Output Voltage DC	Rated Output Current	Rated Power	Dim %	IP Rating
Switched	CEN-60-24	90-295V	24V	2.5A	60W	-	IP67
	HLG-60H-24	90-305V	24V	2.5A	60W	-	IP67
	HLG-100H-24	90-305V	24V	4.0A	100W	-	IP67
	HLG-150H-24	90-305V	24V	6.3A	150W	-	IP67
	HLG-240H-24	90-305V	24V	10A	240W	-	IP67
0-10V (1-10V)	PWM-40-24	90-305V	24V	1.67A	40W	100-0.15 (100-10)	IP67
	PWM-60-24	90-305V	24V	2.5A	60W	100-0.15 (100-10)	IP67
	PWM-90-24	90-305V	24V	3.67A	90W	100-0.15 (100-10)	IP67
	PWM-120-24	90-305V	24V	5.0A	120W	100-0.15 (100-10)	IP67
DALI	LIN100A1	120-277V	24V	1A per channel	100W	100-0.1	IP66/IP40
DMX RGB	LIN100A1	120-277V	24V	1.33A per channel	100W	100-0.1	IP66/IP40
DMX RGBW	LIN100A1	120-277A	24V	1A per channel	100W	100-0.1	IP66/IP40

Flicker Free Options - Combination of PSU+ sub-controller

Control Mode	PSU (Order Code)	Sub-controller (Order Code)	Input Voltage AC	Output Voltage DC	Rated Output Current	Rated Power	Dim %	IP Rating PSU/ Sub-controller
0-10V or 1-10V	CEN-60-24	KKDM-06	90-295V	24V	2.5A	60W	100-0.9	IP67/IP20
	HLG-60H-24	KKDM-06	90-295V	24V	2.5A	60W	100-0.9	IP67/IP20
	HLG-100H-24	KKDM-06	90-295V	24V	4.0A	100W	100-0.9	IP67/IP20
	HLG-150H-24	KKDM-06	90-295V	24V	6.3A	150W	100-0.9	IP67/IP20
	HLG-240H-24	KKDM-06	90-295V	24V	10.0A	240W	100-0.9	IP67/IP20
DALI	CEN-60-24	KKDL-02/03	90-295V	24V	2.5A	60W	100-0.1	IP67/IP20
	HLG-60H-24	KKDL-02/03	90-305V	24V	2.5A	60W	100-0.1	IP67/IP20
	HLG-100H-24	KKDL-02/03	90-305V	24V	4.0A	100W	100-0.1	IP67/IP20
	HLG-150H-24	KKDL-02/03	90-305V	24V	6.3A	150W	100-0.1	IP67/IP20
	HLG-240H-24	KKDL-02/03	90-305V	24V	10.0A	240W	100-0.1	IP67/IP20
DMX RGB	CEN-60-24	KKSC-05	90-295V	24V	2.5A	60W	100-0.9	IP67/IP20
	HLG-60H-24	KKSC-05	90-305V	24V	2.5A	60W	100-0.9	IP67/IP20
	HLG-100H-24	KKSC-05	90-305V	24V	4A	100W	100-0.9	IP67/IP20
	HLG-150H-24	KKSC-05	90-305V	24V	6.3A	150W	100-0.9	IP67/IP20
	HLG-240H-24	KKSC-05	90-305V	24V	10.0A	240W	100-0.9	IP67/IP20

¹ The items shown above cover the most frequently used specification but does not exhaust the possible options

² PSU and/or driver can be chosen from the table, or KKDC may recommend the best option upon receipt of the controls requirement and installation environment

³ Electrical shop drawing will include detailed information of PSU and relevant control drivers

⁴ Cut sheets are available on the controls section of www.kkdc.lighting or upon request