

Linear

MoMo-F A040 (40W) Fixture Guide

KKDÖ

Indoor/Outdoor | Recessed | High output up to 1640lm/m (500lm/ft)



Key applications

- ✓ Bathrooms
- ✓ Interior/Exterior
- ✓ Orientation lighting
- ✓ Public spaces
- ✓ Uplighting
- ✓ Wall grazing

Key features

- ✓ Custom lengths
- ✓ Diffusion: Homogenous
- ✓ Direct view
- ✓ Extensive CCT range
- ✓ Form factor: Large
- ✓ High lumen efficacy
- ✓ In-ground walkover
- ✓ IP67
- ✓ Output high

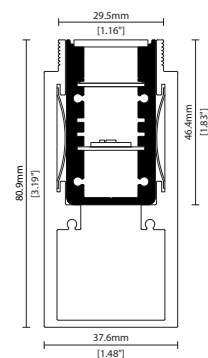

MOUNTING METHODS



KKFR-03 Ground box

Linear

MoMo-F A040 (40W)

Specification sheet



Dimension	H46.4/W25/L87-1510mm (H1.83/W0.98/L3.43-59.45in)	
PCB increment	38.46mm increment/1500mm max (1.51in increment/59.06in max)	
LED pitch	4.8mm - 208LED/m (0.19in - 64LED/ft)	
Chip	A-line	
Beam angle	110° (Diffused Cover)	
Colours	A-line	2700K/3000K/4000K
Bin/Step	A-line	3-step MacAdam ellipse
CRI	94	
Lifetime	50,000 hours @ 25°C (50,000 hours @ 77°F)	
Operating temp	T _a = -20 to 40°C (T _c max = 83.9°C) T _a = -13 to 113°F (T _c max = 183°F)	
IP rating	IP67	
Finish	Silver anodised	
Cover/lens	Diffused	
Mounting	Ground recessed	
Power feed	Sheathed hardwire tails or male/female connectors	
Control	0-10V/1-10V/DMX/DALI	
IK Rating	IEC 62262:2010/IK08	

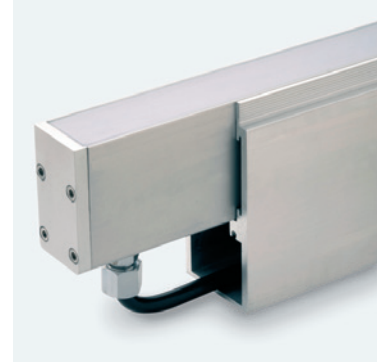

LED Grading Key

Exclusive Grade	*KKDC tuned CCT range
A-line*	CCT range
3-step CCT range	
KKDC highest lumen efficacy LED	

PERFORMANCE DATA @ 3000K

Power consumption	Supply voltage	Supply current
40W/m (12.19W/ft)	24V DC	1.67A/m (0.51A/ft)

Colour Rendering Index (CRI)

	R1	R2	R3	R4	R5	R6	R7	R8	R9	R10	R11	R12	R13	R14
A-line	94	95	94	94	93	93	95	87	69	87	94	77	94	96

Diffused Cover

A-line	1640lm/m (500lm/ft) 41lm/W	CRI	R9	Rf	Rg
		94	69	-	-

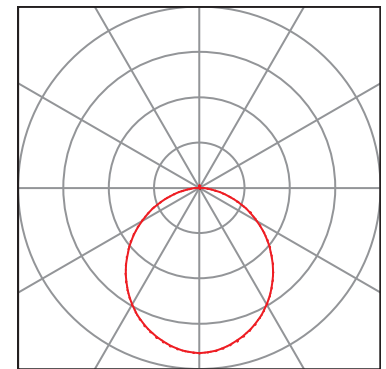
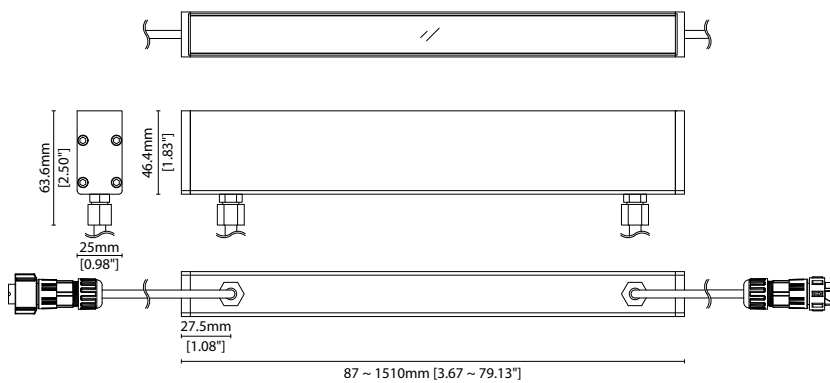

— C0 / C180 cd / 1000 lm C90 / C270

Data derived from independent UKAS/IESNA LM-79-08 accredited testing of production samples.

Linear

MoMo-F A040 (40W)

Code Table



FIXTURE

Model	Finish	Cover ¹	Grade ²	LED	Colour (CCT)	Length Availability ³	IP	Cable Length	Power Feed ⁴	Input
MoMo-F MF	Silver Anodised SA	Diffused C	A- A	040	2700K 27 3000K 30 4000K 40	m 87-1510mm 38.46mm increments i 3.43-59.45in 1.51in increments (Specify length code OR total run length)	IP67 67	300mm/11.81" 0300	Single ø6.3mm sheath tail S00B Double ø6.3mm sheath tail D00B Single ø6.3mm sheath IP67 connector S67B Double ø6.3mm sheath IP67 connector D67B	DC 24V g

¹ Refer to Cover/Lens Options on Options pages

² Refer to LED Grading Key on Specification sheet page

³ Refer to Length Availability List or enter total run length instead of length code

⁴ Refer to Power Feed Options on Options pages

Code Example:

MF	-	SA	-	C	-	A	-	040	-	30	-	m	500	-	67	-	0300	-	D00B	-	g
MoMo-F		Silver Anodised		Diffused		A-		040		3000K		500mm		IP67		300mm/11.81"		Double ø6.3mm sheath tail		DC 24V	

ACCESSORIES

Mounting Accessories

KKFR-03	Ground box
---------	------------

* Refer to Mounting accessories on Accessories pages

Connection Accessories

CN67-2P-0300	IP67 2 PIN male & female 300mm/11.81" pair
CN67-2P-1000	IP67 2 PIN male & female 1000mm/39.37" pair
CN67-2P-3000	IP67 2 PIN male & female 3000mm/118.11" pair

* Refer to Power feed on Accessories pages

Exterior Junction Boxes

KKJB-07	IP67 Slim J-Box
KKJB-07R	Potting Resin for IP67 Slim J-Box

* Refer to Exterior Junction Boxes on Accessories pages

PSU/Driver

0-10V/1-10V/DALI/DMX

* Refer to Driver/PSU Options page for details or provide requirement and KKDC to offer the suitable option

LED ENGINE VARIANTS (LED STRIP TYPE)

Colour	Output	LED	Lumen/m	Lumen/ft	W/m	W/ft	Spec Doc	Length	Increment
Single CCT	Low	352	140	43	5.5	1.67	MoMo-F 352	93.3-2010mm (3.67-79.13in)	83.3mm (3.28in)
	Low	504	340	104	12.5	3.81	MoMo-F 504	110-2010mm (4.33-79.13in)	100mm (3.94in)
	Low	508	470	143	17.5	5.33	MoMo-F 508	81.4-2010mm (3.20-79.13in)	71.4mm (2.81in)
	Mid	512	810	247	30.2	9.2	MoMo-F 512	81.4-2010mm (3.20-79.13in)	71.4mm (2.81in)
	High	040	1640	500	40	12.19	MoMo-F A040	87-1510mm (3.43-59.45in)	38.46mm (1.51in)
RGB		501	Red 41 Green 88 Blue 14 RGB 127	Red 12 Green 27 Blue 44 RGB 39	15.6	4.75	MoMo-F RGB	93.3-2010mm (3.67-79.13in)	83.3mm (3.28in)

* Performance data: A/s/e-line, diffused cover, 3000K

Linear

MoMo-F A040 (40W)

Length Availability List



Length Code		Fixture Length ¹		LED Strip ²		End Cap Dimension ³		Wattage (W)	Output (lm)
Metric	Imperial(US)	Metric	Imperial(US)	Metric	Imperial(US)	Metric	Imperial(US)		3000K (Test Data)
m0087	i0003	87mm	3.43in	77mm	3.03in	10mm	0.39in	3.08	126
m0125	i0005	125mm	4.94in	115mm	4.55in	10mm	0.39in	4.62	189
m0164	i0006	164mm	6.45in	154mm	6.06in	10mm	0.39in	6.16	252
m0202	i0008	202mm	7.97in	192mm	7.57in	10mm	0.39in	7.70	316
m0241	i0009	241mm	9.48in	231mm	9.09in	10mm	0.39in	9.23	379
m0279	i0011	279mm	11.00in	269mm	10.60in	10mm	0.39in	10.77	442
m0318	i0013	318mm	12.51in	308mm	12.12in	10mm	0.39in	12.31	505
m0356	i0014	356mm	14.02in	346mm	13.63in	10mm	0.39in	13.85	568
m0395	i0016	395mm	15.54in	385mm	15.14in	10mm	0.39in	15.39	631
m0433	i0017	433mm	17.05in	423mm	16.66in	10mm	0.39in	16.93	694
m0472	i0019	472mm	18.57in	462mm	18.17in	10mm	0.39in	18.46	757
m0510	i0020	510mm	20.08in	500mm	19.69in	10mm	0.39in	20.00	820
m0549	i0022	549mm	21.60in	539mm	21.20in	10mm	0.39in	21.54	883
m0587	i0023	587mm	23.11in	577mm	22.72in	10mm	0.39in	23.08	946
m0625	i0025	625mm	24.62in	615mm	24.23in	10mm	0.39in	24.62	1009
m0664	i0026	664mm	26.14in	654mm	25.74in	10mm	0.39in	26.16	1072
m0702	i0028	702mm	27.65in	692mm	27.26in	10mm	0.39in	27.69	1135
m0741	i0029	741mm	29.17in	731mm	28.77in	10mm	0.39in	29.23	1199
m0779	i0031	779mm	30.68in	769mm	30.29in	10mm	0.39in	30.77	1262
m0818	i0032	818mm	32.19in	808mm	31.80in	10mm	0.39in	32.31	1325
m0856	i0034	856mm	33.71in	846mm	33.31in	10mm	0.39in	33.85	1388
m0895	i0035	895mm	35.22in	885mm	34.83in	10mm	0.39in	35.39	1451
m0933	i0037	933mm	36.74in	923mm	36.34in	10mm	0.39in	36.92	1514
m0972	i0038	972mm	38.25in	962mm	37.86in	10mm	0.39in	38.46	1577
m1010	i0040	1010mm	39.77in	1000mm	39.37in	10mm	0.39in	40.00	1640
m1049	i0041	1049mm	41.28in	1039mm	40.89in	10mm	0.39in	41.54	1703
m1087	i0043	1087mm	42.79in	1077mm	42.40in	10mm	0.39in	43.08	1766
m1125	i0044	1125mm	44.31in	1115mm	43.91in	10mm	0.39in	44.62	1829
m1164	i0046	1164mm	45.82in	1154mm	45.43in	10mm	0.39in	46.16	1892
m1202	i0047	1202mm	47.34in	1192mm	46.94in	10mm	0.39in	47.69	1955
m1241	i0049	1241mm	48.85in	1231mm	48.46in	10mm	0.39in	49.23	2019
m1279	i0050	1279mm	50.36in	1269mm	49.97in	10mm	0.39in	50.77	2082
m1318	i0052	1318mm	51.88in	1308mm	51.49in	10mm	0.39in	52.31	2145
m1356	i0053	1356mm	53.39in	1346mm	53.00in	10mm	0.39in	53.85	2208
m1395	i0055	1395mm	54.91in	1385mm	54.51in	10mm	0.39in	55.39	2271
m1433	i0056	1433mm	56.42in	1423mm	56.03in	10mm	0.39in	56.92	2334
m1472	i0058	1472mm	57.94in	1462mm	57.54in	10mm	0.39in	58.46	2397
m1510	i0059	1510mm	59.45in	1500mm	59.06in	10mm	0.39in	60.00	2460

¹ Actual total overall length of light fixture (LED strip + end caps + void/wire hole)

² Actual length of PCB strip

³ Actual length of 2x end caps

Linear

MoMo-F A040 (40W)

Length Availability List

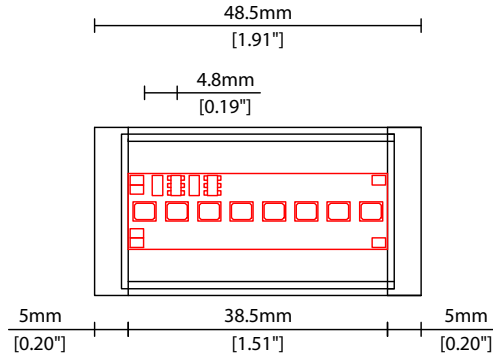

Linear

MoMo-F A040 (40W) Options

KKDC

COVER/LENS OPTIONS

* Options are an integral part of the fixture ordering codes. Please refer to **Code Table** pages.

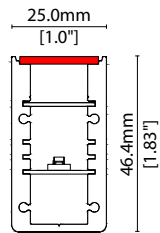

C Diffused Cover
W25.0/H46.4mm (W1.00/H1.83")

POWER FEED OPTIONS

* Options are an integral part of the fixture ordering codes. Please refer to **Code Table** pages.

0300 S00B 300mm (11.81") Single Ø6.3mm sheath tail

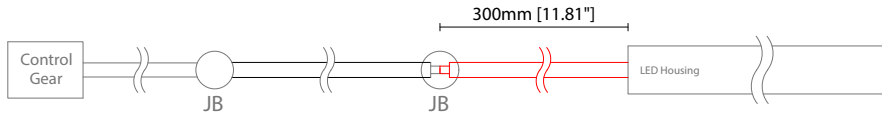

0300 D00B 300mm (11.81") Double Ø6.3mm sheath tail

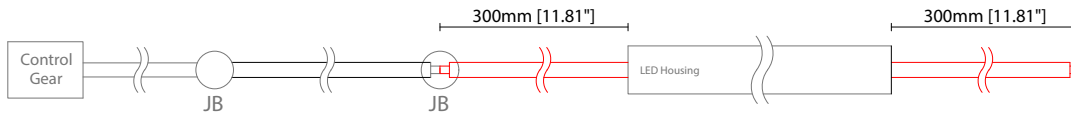

0300 S67B 300mm (11.81") Single Ø6.3mm sheath IP67 connector

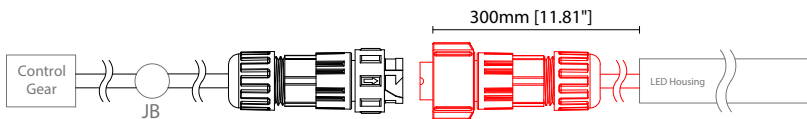

0300 D67B 300mm (11.81") Double Ø6.3mm sheath IP67 connector

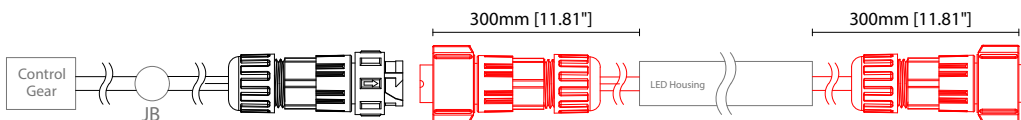

IP67 2 Pin Connector

Female connector
2 PIN (IP67)

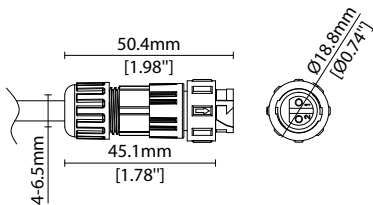

Male connector
2 PIN (IP67)

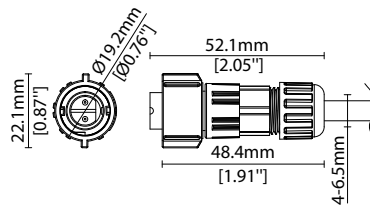

Key

- Control Gear Power supply, sub-controllers & control systems
- JB Junction box / cable connection

Linear

MoMo-F A040 (40W) Accessories

KKDC

MOUNTING ACCESSORIES

Note: Accessories are to be ordered separately with corresponding code shown below.

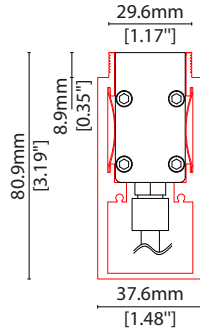

KKFR-03*

Ground box

Anodised aluminium finish

W37.6/H80.9mm (W1.48/H3.19")

* Specify length to match MoMo-F

POWER FEED

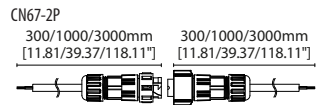

CN67-2P-0300 300mm (11.81in) pair

CN67-2P-1000 1000mm (39.37in) pair

CN67-2P-3000 3000mm (118.11in) pair

IP67

2 PIN male + female connector set

EXTERIOR JUNCTION BOXES



KKJB-07

IP67 Slim J-Box
(including type A,B,C, D bushings)



KKJB-07R

Potting resin for IP67 Slim J-Box

Linear

MoMo-F A040 (40W)

Accessories

KKDC

KKDC CONTROL



IP20
Plastic housing
L170/W59/H29mm
(L6.69/W2.32/H1.14in)

KKDM-06 1-10V

visDIM dimmable sub-controller
(4 x 8A max @ 12-36V)



IP20
Plastic housing
L170/W53.4/H28mm
(L6.69/W2.10/H1.10in)

KKSC-05 DMX

visDIM dimmable sub-controller
(4 x 5A max @ 12-36V)



IP20
Plastic housing
L170/W59/H29mm
(L6.69/W2.32/H1.14in)

KKDL-02 DALI

visDIM dimmable sub-controller
(4 x 8A max @ 12-36V)



IP20
Plastic housing
L166/W53.4/H23mm
(L6.54/W2.10/H0.91in)

KKDL-03 DALI

visDIM dimmable sub-controller
(4 x 5A max @ 12-36V)

AVAILABLE PSU OPTIONS

Control Mode	PSU (Order Code)	Input Voltage AC	Output Voltage DC	Rated Output Current	Rated Power	Dim %	IP Rating
Switched	CEN-60-24	90-295V	24V	2.5A	60W	-	IP67
	HLG-60H-24	90-305V	24V	2.5A	60W	-	IP67
	HLG-100H-24	90-305V	24V	4.0A	100W	-	IP67
	HLG-150H-24	90-305V	24V	6.3A	150W	-	IP67
	HLG-240H-24	90-305V	24V	10A	240W	-	IP67
0-10V (1-10V)	PWM-40-24	90-305V	24V	1.67A	40W	100-0.15 (100-10)	IP67
	PWM-60-24	90-305V	24V	2.5A	60W	100-0.15 (100-10)	IP67
	PWM-90-24	90-305V	24V	3.67A	90W	100-0.15 (100-10)	IP67
	PWM-120-24	90-305V	24V	5.0A	120W	100-0.15 (100-10)	IP67
DALI	LIN100A1	120-277V	24V	1A per channel	100W	100-0.1	IP66/IP40
DMX RGB	LIN100A1	120-277V	24V	1.33A per channel	100W	100-0.1	IP66/IP40
DMX RGBW	LIN100A1	120-277A	24V	1A per channel	100W	100-0.1	IP66/IP40

Flicker Free Options - Combination of PSU+ sub-controller

Control Mode	PSU (Order Code)	Sub-controller (Order Code)	Input Voltage AC	Output Voltage DC	Rated Output Current	Rated Power	Dim %	IP Rating PSU/ Sub-controller
0-10V or 1-10V	CEN-60-24	KKDM-06	90-295V	24V	2.5A	60W	100-0.9	IP67/IP20
	HLG-60H-24	KKDM-06	90-295V	24V	2.5A	60W	100-0.9	IP67/IP20
	HLG-100H-24	KKDM-06	90-295V	24V	4.0A	100W	100-0.9	IP67/IP20
	HLG-150H-24	KKDM-06	90-295V	24V	6.3A	150W	100-0.9	IP67/IP20
	HLG-240H-24	KKDM-06	90-295V	24V	10.0A	240W	100-0.9	IP67/IP20
DALI	CEN-60-24	KKDL-02/03	90-295V	24V	2.5A	60W	100-0.1	IP67/IP20
	HLG-60H-24	KKDL-02/03	90-305V	24V	2.5A	60W	100-0.1	IP67/IP20
	HLG-100H-24	KKDL-02/03	90-305V	24V	4.0A	100W	100-0.1	IP67/IP20
	HLG-150H-24	KKDL-02/03	90-305V	24V	6.3A	150W	100-0.1	IP67/IP20
	HLG-240H-24	KKDL-02/03	90-305V	24V	10.0A	240W	100-0.1	IP67/IP20
DMX RGB	CEN-60-24	KKSC-05	90-295V	24V	2.5A	60W	100-0.9	IP67/IP20
	HLG-60H-24	KKSC-05	90-305V	24V	2.5A	60W	100-0.9	IP67/IP20
	HLG-100H-24	KKSC-05	90-305V	24V	4A	100W	100-0.9	IP67/IP20
	HLG-150H-24	KKSC-05	90-305V	24V	6.3A	150W	100-0.9	IP67/IP20
	HLG-240H-24	KKSC-05	90-305V	24V	10.0A	240W	100-0.9	IP67/IP20

¹ The items shown above cover the most frequently used specification but does not exhaust the possible options

² PSU and/or driver can be chosen from the table, or KKDC may recommend the best option upon receipt of the controls requirement and installation environment

³ Electrical shop drawing will include detailed information of PSU and relevant control drivers

⁴ Cut sheets are available on the controls section of www.kkdc.lighting or upon request