

# WALO LED

SURFACE



**LUMENWERX**  
WWW.LUMENWERX.COM

## CHROMAWERX QUADRO - RGBW

**IMPORTANT: a qualified DMX integration consultant is required to ensure proper installation and function of any DMX network**

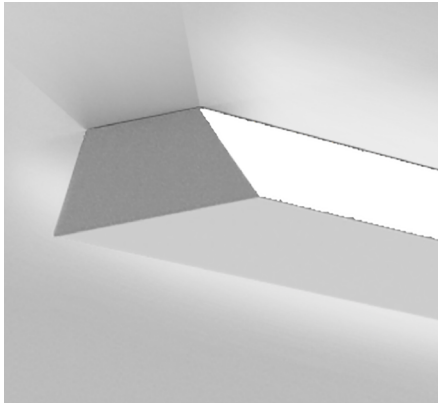

Surface

### DESCRIPTION

**Walo** is a linear luminaire that casts light to either side, reflecting off of the adjacent surface. The resulting parallel bands of brightness define and delineate pathways. WALO can be used individually or in patterns. A full suite of on-board driver, battery pack and electrical options makes WALO a practical approach for lighting circulation areas. Walo is an ideal vehicle for Chromawerx color tuning in education, office, and healthcare applications where modular luminaires are used.

**PROJECT:** \_\_\_\_\_  
 \_\_\_\_\_  
**TYPE:** \_\_\_\_\_  
 \_\_\_\_\_  
**NOTES:** \_\_\_\_\_  
 \_\_\_\_\_



### ORDER GUIDE

| WALS                       | HLO   | LED                               | CHROMAWERX  | OUTPUT WATTAGE   |
|----------------------------|---|-----------------------------------|---|--|
| LUMINAIRE ID               | OPTICS  | LIGHT SOURCE                      | CHROMAWERX  | OUTPUT WATTAGE   |
| <b>WALS</b> - walo surface | <b>HLO</b> - High-Efficiency Lambertian Optic | <b>LED</b> - high performance LED | <b>QUADRO</b> - four-channel RGB with 3500K white<br><b>RS</b> - red solid<br><b>GS</b> - green solid<br><b>BS</b> - blue solid | <b>7WF</b> - 7 W/ft output (for solid colors only)<br><b>7WF</b> - 7 W/ft output (quadro only)<br><b>9WF</b> - 9 W/ft output (quadro only) |

| LUMINAIRE LENGTH  | VOLTAGE                                | DRIVER   | ELECTRICAL           | MOUNTING                     |
|---|--|--|----------------------|------------------------------|
| Available sections - 4', 8' & 12'<br>#FT - nominal length in feet<br><b>(2' increments only)</b><br>Continuous Run - for luminaires over 12'<br>Minimum Individual section 4' | <b>120</b> - 120V<br><b>277</b> - 277V | <b>DMX</b> - to specify see pages 4 to 9<br><b>DA</b> - DALI (solid colors only) local on-site commissioning is required<br><b>O-10</b> - O-10 (solid colors only) | <b>1</b> - 1 circuit | <b>DRC</b> - drywall ceiling |

See page 2 for ordering code detailed information

| FINISH  | OPTIONS                                |
|---|--|
| <b>W</b> - matte white<br><b>AL</b> - aluminum<br><b>CF#</b> - custom finish specify RAL# | <b>FU</b> - fuse<br><b>CU</b> - custom |

| DMX WALL CONTROLS           |
|-----------------------------|
| To specify see pages 4 to 9 |

### CROSS SECTION

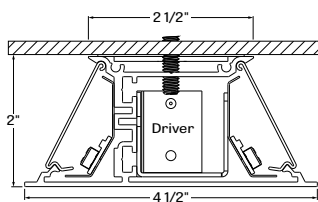

**WALS** - surface

### OPTICS



**HLO** - High-efficiency Lambertian Optic

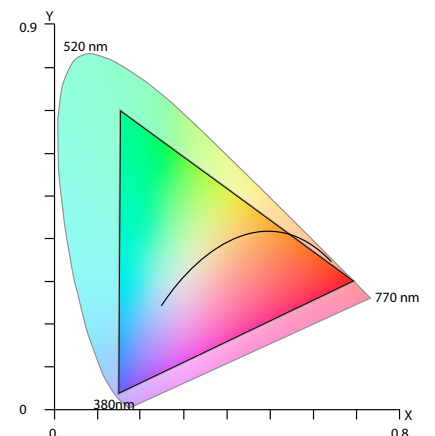

## CHROMAWERX QUADRO - RGBW

### OPTICS

**HIGH EFFICIENCY LAMBERTIAN OPTIC (HLO)** - Matte white side reflectors combined with High-Efficiency Lambertian Optic (HLO) shielding of diffusing 0.075" thick acrylic with up to 88% transmission and good source obscuration. Luminaire brightness is controlled by the flux-to-shielding area ratio.

### LIGHT SOURCE - LED

Custom linear array of mid-flux LEDs, comprised of an alternation of an RGB and a dedicated white LED. The white LED is used for when a static white CCT is required in the space. RGB LEDs are tightly binned for excellent color control between fixtures. The white LEDs have been tested in accordance with IESNA LM-80-08 and the results have shown L80 lumen maintenance greater than 60,000 hours. Absolute product photometry is measured and presented in accordance with IESNA LM-79, unless otherwise indicated.

### LUMINAIRE LENGTH

Walo is made up of standard 4, 8 and 12 foot sections that may be joined together to create longer continuous run lengths. Exact run length must be noted in the product code. The minimum individual section available is 4 foot, and continuous run lengths can be ordered in 2 foot increments. All individual sections are joined together onsite using the joiner kits provided. Lumenwerx offers joiner kits that are extremely simple to work with in the field and result in a fixture that appears virtually seamless with no light leak at any connection.

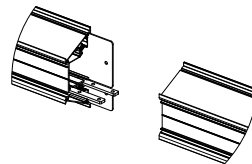

joining system Walo

### CHROMAWERX - RGBW

**Chromawerx Quadro** is a four-channel control that operates an RGBW LED array and addresses the need for more expressive color in architectural applications. The DMX driver supports familiar programming tools for both dynamic multi-hued color and precise white color point control. While a typical user interface will be a DMX controller by others, Lumenwerx also offers a simple control station for stand-alone color changing applications.

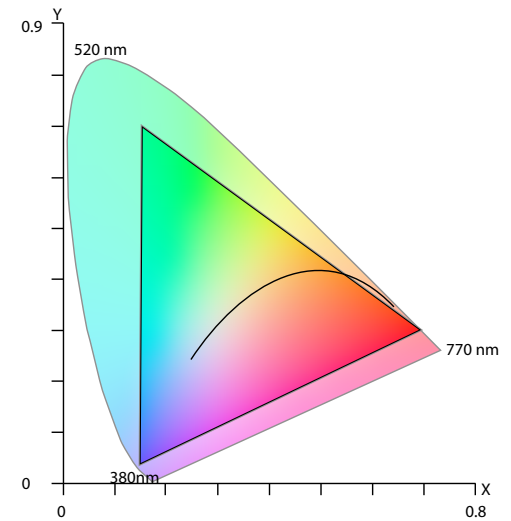

CIE 1931 Chromaticity space

The above diagram overlays the full gamut of colors attainable with the RGBW on top of the CIE 1931 color space. Any color point inside of the triangle can be obtained by setting the correct output levels for each of the individual red, green, blue, and white channels.

### ELECTRICAL

#### DMX

Factory-set, adjustable output current, multi-channel LED driver with universal (120-277VAC) input. Using DMX wall controls (optionally supplied by Lumenwerx) or an existing DMX control system, four channels of LEDs (Red/Green/Blue/White) are independently adjustable. Each DMX driver has multiple output channels that can be independently addressed at the factory or on-site using built-in RDM (Remote Device Management) functionality. Dimming range from 100%-0%. At maximum driver load, efficiency<89%, PF>0.9, THD<20%.

### CHROMAWERX QUADRO - RGBW

#### MOUNTING OPTIONS

Fixtures may be mounted to the ceiling using a threaded rod. For long runs, a minimum of 6" from adjacent walls is required.

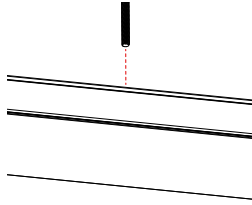

#### FINISH

**Interior** - 95%, reflective matte powder coated white paint

**Exterior** - matte white or aluminum powder coating.

Custom finishes are also available.

#### CONSTRUCTION

**Housing** - Extruded aluminum (0.07" nominal) up to 90% recycled content

**Interior brackets** - Die formed cold rolled sheet steel 16 gauge thick

**Joining system** - Cold rolled steel

**Reflectors** - Cold rolled steel 0.024" thick precisely die formed, 95% reflective matte white painted

**End caps** - Aluminum plate 0.125" thickness

#### WEIGHT

**WALO 4ft** - 7.63lbs - 3.46kg

**WALO 8ft** - 13.78lbs - 6.25kg

**WALO 12ft** - 21lbs - 9.53kg

#### CERTIFICATIONS

**ETL** - Rated for Indoor Dry/Damp locations. Conforms to UL Standard 1598 and certified to CAN/CSA Standard C22.2 No. 250.0.

#### WARRANTY

For all Chromawerx products, Lumenwerx provides a five-year limited warranty of electrical and mechanical performance of the luminaires, including the LED boards, drivers, and auxiliary electronics. Lumenwerx will repair or replace defective luminaires or components at our discretion, provided they have been installed and operated in accordance with our specifications. Other limitations apply, please refer to the full warranty on our website.

Wall controllers are covered by the manufacturer warranty.

CHROMAWERX QUADRO - RGBW

QUADRO DMX SPECIFICATION

A qualified DMX integrator is required to assure proper installation and commissioning of the DMX network. **When placing the PO, please provide the contact information of your DMX integrator.**

Please answer the following questions to help us identify your DMX network requirements.

YES

Do you require a wall controller provided by Lumenwerx?

NO

DMX control system supplied by others. Lumenwerx will supply DMX-enabled fixtures with default DMX addressing. See following pages for technical DMX informations. ✓

DMX controller supplied by Lumenwerx

How many zones do you have?  
A zone consists of one or more luminaires behaving identically.

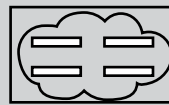

1 Zone

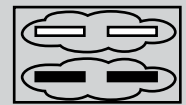

2 Zones

How to calculate the required number of drivers:

per 4' fixture  
Driver  
1x driver  
Less than 12.5W/ft, direct only

per 4' fixture  
Driver Driver  
2x driver  
Above 12.5W/ft or for all direct/indirect fixture

To Calculate # of drivers

1 Zone

2 to 3 Zones

4 or more Zones

Do you have more than 32 drivers in total?

NO

YES

Order a standard Lumenwerx wall controller type 1.

WALL CONTROLLER

WC1W - Single zone wall controller white  
WC1B - Single zone wall controller black

Add the control code at the end of your order code. Please provide a fixture layout or RCP (Reflected Ceiling Plan) showing the locations of the DMX fixtures, zones and the DMX wall controller. Refer to your DMX integrator for the installation. ✓

Subject to factory evaluation. Please contact our controls specialist at controls@lumenwerx.com Additional cost and equipment will be required. ✓

NO

YES

Order a standard Lumenwerx wall controller type 2.

WALL CONTROLLER

WC2W - 3 zone wall controller white  
WC2B - 3 zone wall controller black

Add the control code at the end of your order code. Please provide a fixture layout or RCP (Reflected Ceiling Plan) showing the locations of the DMX fixtures, zones and the DMX wall controller. Refer to your DMX integrator for the installation. ✓

Subject to factory evaluation. Please contact our controls specialist at controls@lumenwerx.com Additional cost and equipment will be required. ✓

Subject to factory evaluation and approval. Please contact our controls specialist at controls@lumenwerx.com Additional cost and equipment will be required. ✓

CHROMAWERX QUADRO - RGBW

GENERIC DMX NETWORK ARCHITECTURE

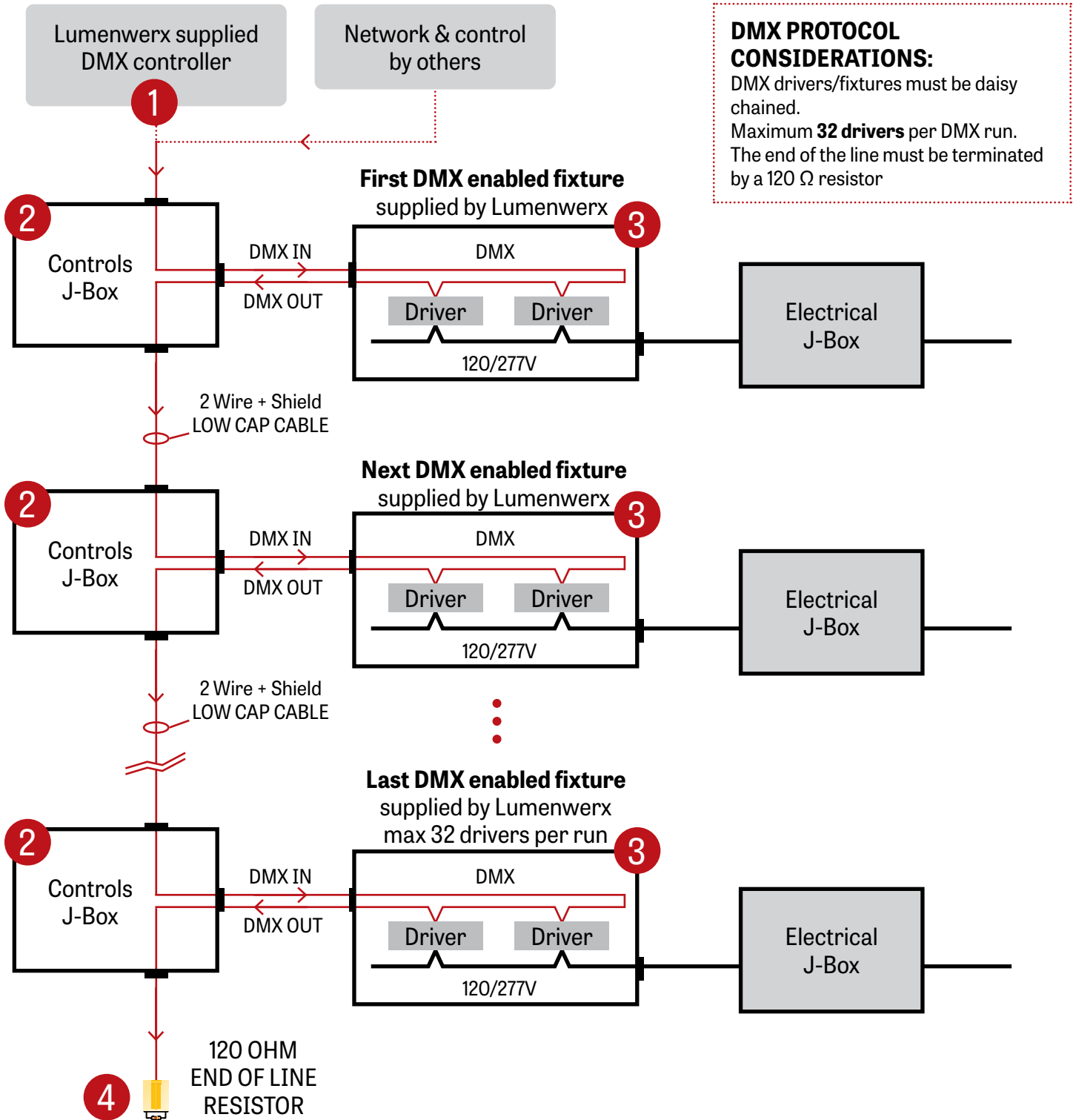

## CHROMAWERX QUADRO - RGBW

### 1 LUMENWERX SUPPLIED DMX CONTROLLER

To the first fixture

WALL BOX SUPPLIED BY OTHERS

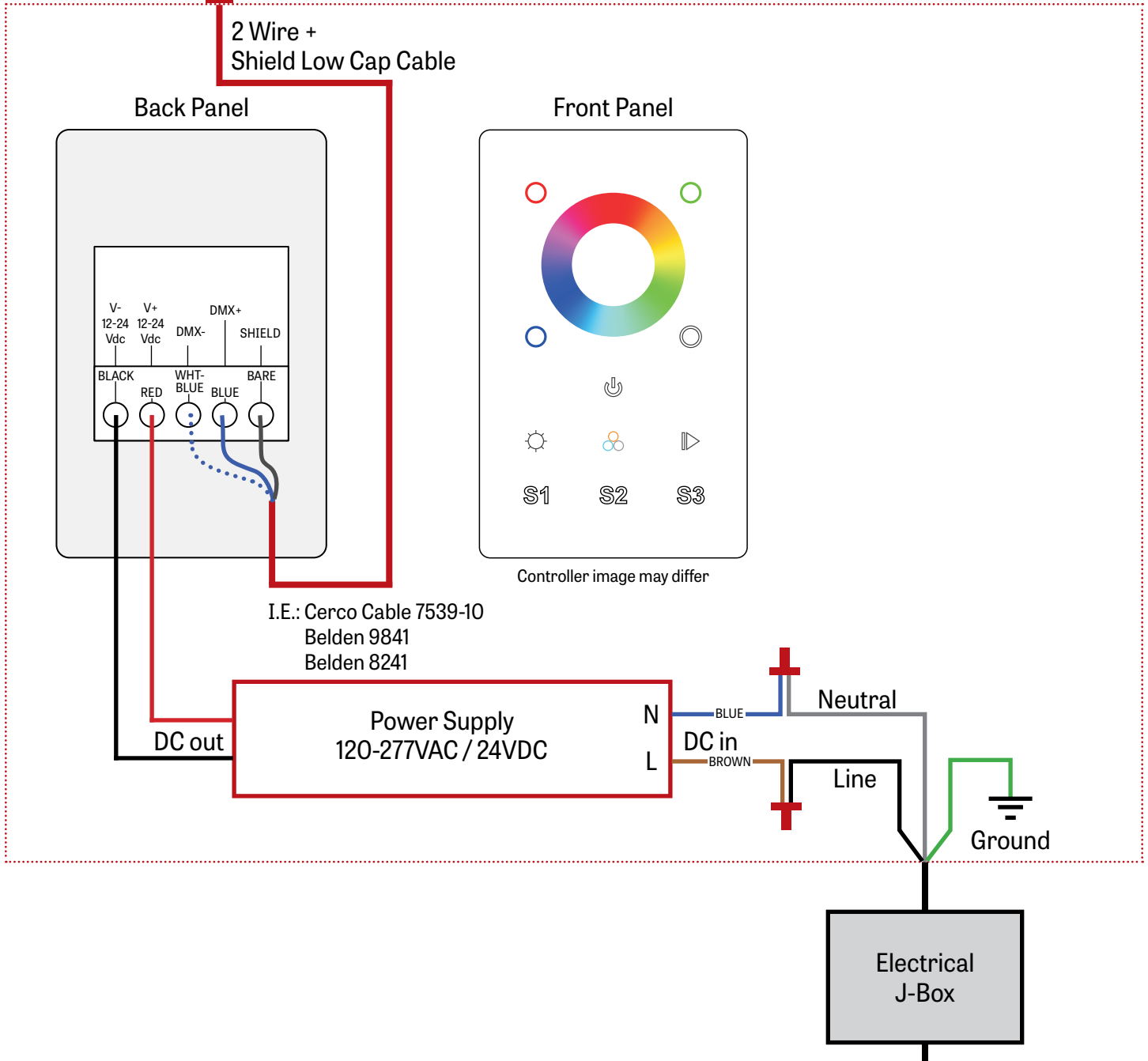

CHROMAWERX QUADRO - RGBW

2 J-BOX DMX DAISY CHAIN DETAIL

Low capacitance DMX Cable from Previous Fixture

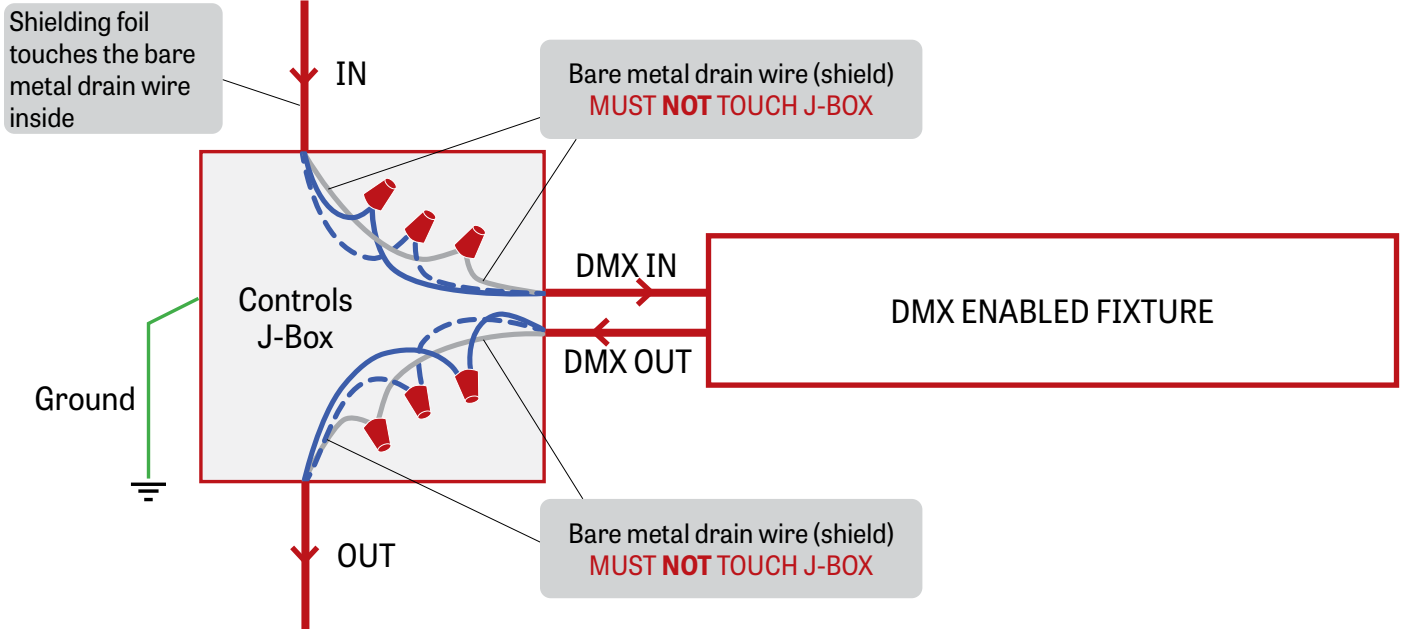

Low capacitance DMX cable to next fixture

3 DMX CONNECTION RECESSED & SURFACE

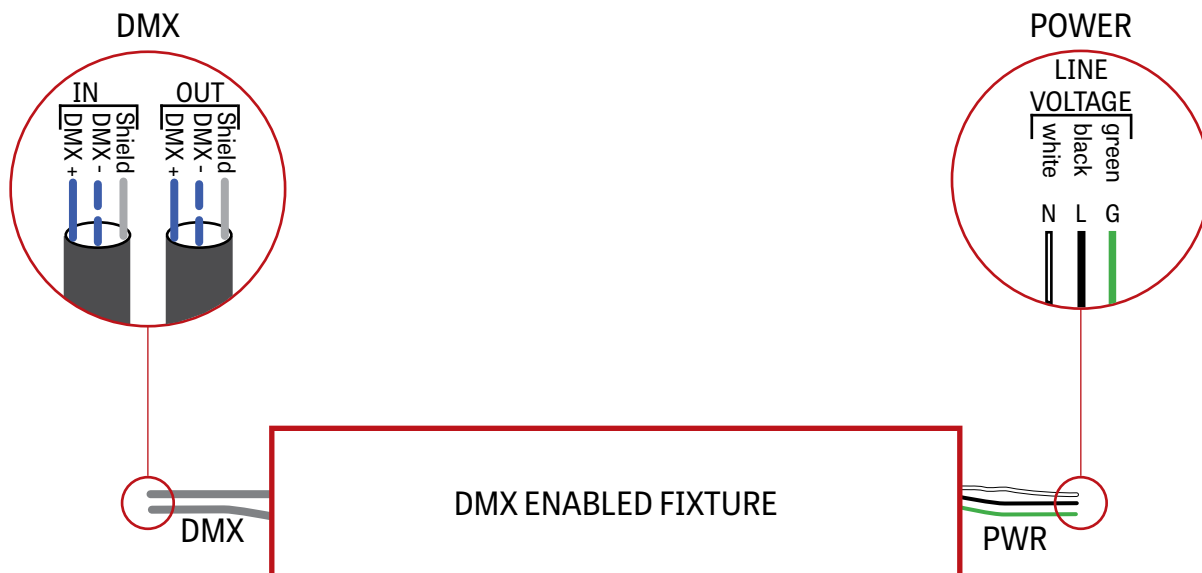

CHROMAWERX QUADRO - RGBW

4 DMX LAST FIXTURE DETAIL

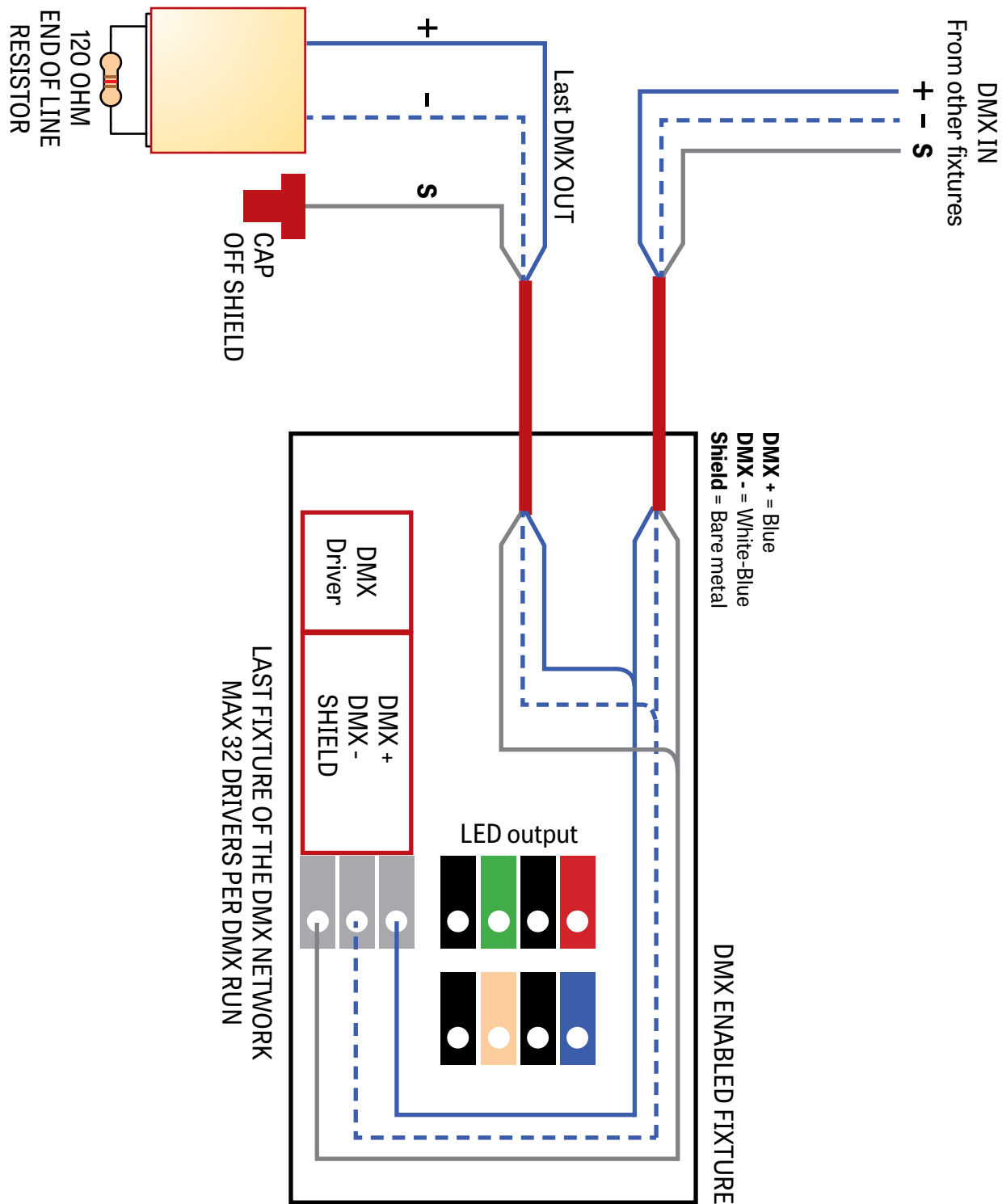



## CHROMAWERX QUADRO - RGBW

### DMX WALL CONTROLLER

#### WC1

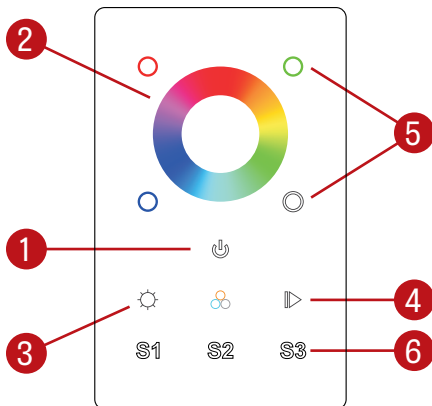

- (1) Power: Use this button to turn ON or OFF the RGBW fixture.
- (2) Color Wheel: The wheel is used to rapidly select a color (RGB colors only).
- (3) Brightness (RGB): Hold down this button to either increase or decrease the brightness of the current RGB selection. White will not be affected by the RGB brightness button.
- (4) Color Cycle: This button will start an animation, rotating between Reds Greens and Blues, the arrows allow the user to speed up or slow down the animation.
- (5) Individual Colors: By pressing and holding a color it will be possible to brighten or dim it. Quickly pressing a color will turn it OFF or turn it ON to its previous dim level.  
White: In order to activate or deactivate and dim the White channel, the White button needs to be used.
- (6) Scenes: By holding down one of the scenes button, the current color selection is saved. It can be later accessed by quickly pressing on one of the Scene buttons.

#### WC2

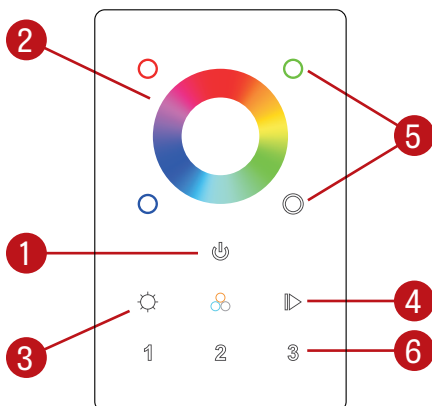

- (1) Power: Use this button to turn ON or OFF the RGBW fixture.
- (2) Color Wheel: The wheel is used to rapidly select a color (RGB colors only).
- (3) Brightness: Hold down this button to either increase or decrease the brightness of the current RGB selection. White will not be affected by the RGB brightness button.
- (4) Color Cycle: This button will start an animation, rotating between Reds Greens and Blues, the arrows allow the user to speed up or slow down the animation.
- (5) Individual Colors: By pressing a color it will be possible to brighten or dim that specific color.  
White: In order to activate or deactivate and dim the White channel, the White button needs to be used.
- (6) Zone: By holding down one of the zone buttons, a zone can be selected and controlled.

#### Default DMX Addresses:

- 1 Red
- 2 Green
- 3 Blue
- 4 White