

WALO LED

SURFACE



LUMENWERX
WWW.LUMENWERX.COM

CHROMAWERX TUNABLE WHITE AND DIM TO WARM

IMPORTANT: a qualified DMX integration consultant is required to ensure proper installation and function of any DMX network

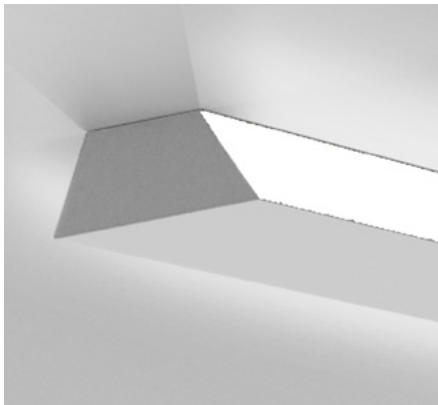

Surface

DESCRIPTION

Walo is a linear luminaire that casts light to either side, reflecting off of the adjacent surface. The resulting parallel bands of brightness define and delineate pathways. Walo can be used individually or in patterns. A full suite of on-board driver, battery pack and electrical options makes Walo a practical approach for lighting circulation areas. Walo is an ideal vehicle for ChromaWerx white tuning in education, office, and healthcare applications where modular luminaires are used.

PROJECT: _____

TYPE: _____

NOTES: _____

ORDER GUIDE

up to 130 lm/w performance

WALS	HLO	LED			
LUMINAIRE ID	OPTICS	LIGHT SOURCE	CRI	LUMEN PACKAGES	CHROMAWERX
WALS - walo surface	HLO - High-Efficiency Lambertian Optic	LED - high performance LED	80 - 80CRI 90 - 90CRI	500 - min. low output 500lm/ft 700 - medium output 700lm/ft 1000 - max. high output 1000lm/ft #### - other required lm/ft	DUO - tunable white 2 channel control 27k to 65k SOLA - dim to warm single channel control 22k to 35k

LUMINAIRE LENGTH	VOLTAGE	DRIVER	ELECTRICAL	MOUNTING
Available sections - 4', 8' & 12' #FT - nominal length in feet (2' increments only) Continuous Run - for luminaires over 12' Minimum Individual section 4'	120 - 120V 277 - 277V	DMX - to specify see pages 4 to 9 DA - Dali (duo only) local on-site commissioning is required O-10 - Single 0-10V input (Sola) or dual 0-10V input for CCT/Intensity (Duo) PSQO - Lutron T-Series 1% Tunable White	1 - 1 circuit	DRC DRC - drywall ceiling

See page 2 for ordering code detailed information

FINISH	OPTIONS
W - matte white AL - aluminum CF# - custom finish specify RAL#	FU - fuse CU - custom

DMX WALL CONTROLS
To specify see pages 4 to 9

CROSS SECTION

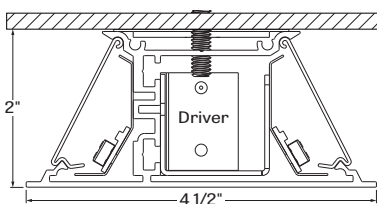

WALS - surface

OPTICS



HLO - High-efficiency Lambertian Optic



ANSI C78.377-2015

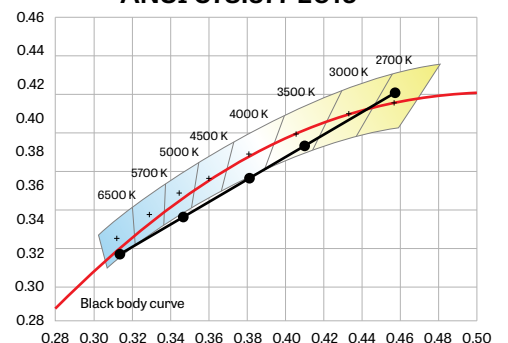

CHROMAWERX TUNABLE WHITE AND DIM TO WARM

OPTICS

HIGH EFFICIENCY LAMBERTIAN OPTIC (HLO) - Matte white side reflectors combined with High-Efficiency Lambertian Optic (HLO) shielding of diffusing 0.075" thick acrylic with up to 88% transmission and good source obscuration. Luminaire brightness is controlled by the flux-to-shielding area ratio.

LIGHT SOURCE - LED

PERFORMANCE PER 4' AT 4000K

LED output	Color Temp	Watts	Nominal Delivered Lumens	Efficacy LPW
low output	4000K	15.5	2000	127
medium output	4000K	21.5	2800	129
high output	4000K	31	4000	130

Lumen Adjustment Factors

2700K	0.917
3000K	0.959
3500K	0.988
4000K	1.000
6500K	1.053

Custom linear array of alternating color temperature mid-flux LED's are mounted directly to the housing for optimal thermal performance. For the Duo products, a color temperature range from 2700K-6500K is achievable with color points on or below the black body curve. For the Sola products, a color temperature range from 2200K-3500K is controlled synchronously with intensity. Color consistency between fixtures is maintained to within 3SDCM. LEDs are operated at reduced drive current to optimize efficacy and lumen maintenance.

All LED's have been tested in accordance with IESNA LM-80-08 and the results have shown L80 lumen maintenance greater than 60,000 hours. Absolute product photometry is measured and presented in accordance with IESNA LM-79, unless otherwise indicated.

LUMINAIRE LENGTH

Walo is made up of standard 4, 8 and 12 foot sections that may be joined together to create longer continuous run lengths. Exact run length must be noted in the product code. The minimum individual section available is 4 foot, and continuous run lengths can be ordered in 2 foot increments. All individual sections are joined together onsite using the joiner kits provided. LumenWerx offers joiner kits that are extremely simple to work with in the field and result in a fixture that appears virtually seamless with no light leak at any connection.

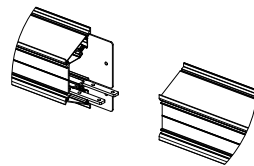

joining system Walo

CHROMAWERX - TUNABLE WHITE

ANSI C78.377-2015

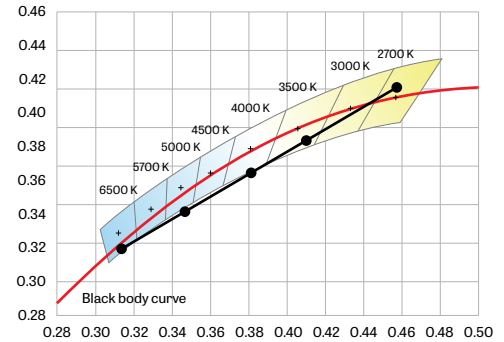

ChromaWerx Sola is single-channel control that dims output while warming the color temperature in a pre-determined relationship. A simple digital or analog control sends a common signal to dual output digital drivers, which are programmed to adjust a specially populated LED array to emulate the effect of dimming a filament source. Dimming range is programmable but the default option runs from 3500K at 100% of full power to 2200K at 5% of full power. CRI is maintained above 80 throughout the dimming range.

ChromaWerx Duo is two-channel control. It uses an analog (0-10V) protocol for separate control of luminaire CCT and intensity or a digital (DMX, DALI) protocol for synchronous control of both warm and cool LED arrays to enable the user to set color temperature and light output. Commonly called "tunable white", ChromaWerx two-channel control provides the range of warm (2700K) to cool (6500K) color that can be useful for helping to entrain circadian rhythms, stimulate alertness for improved educational and work productivity, and compensate for jet lag, among other applications. The ChromaWerx drivers are programmed to limit maximum light output and power usage across all color temperatures. CRI is maintained above 80.

CHROMAWERX TUNABLE WHITE AND DIM TO WARM

ELECTRICAL**DMX (Duo only)**

Factory-set, adjustable output current, multi-channel LED driver with universal (120-277VAC) input. Using DMX wall controls (optionally supplied by LumenWerx) or an existing DMX control system, two channels of LEDs (warm-white & cool-white) are independently adjustable. Each DMX driver has multiple output channels that can be independently addressed at the factory or on-site using built-in RDM (Remote Device Management) functionality. Dimming range from 100%-0%. At maximum driver load, efficiency<89%, PF>0.9, THD<20%.

Dali (Duo Only)

Factory-set, adjustable output current LED driver with universal (120-277VAC) input. Using an existing DALI control system (supplied by others), one control channel adjusts the fixture color temperature, and the other control channel adjusts fixture brightness. Dimming range from 100%-0%. At maximum driver load, efficiency<86%, PF>0.9, THD<20%.

0-10V (Solo)

Factory-set, adjustable output current LED driver with universal (120-277VAC) input. Using a single 0-10V control signal, the light output warms in color temperature as it dims down to 1% and 2200K. At maximum driver load, efficiency<86%, PF>0.9, THD<20%.

0-10V (Duo)

Factory-set adjustable output current LED driver with universal (120-277VAC) input. Controlled via two individual 0-10V signals, one for setting light output down to a minimum of 1% and the other for adjusting the CCT (default range of 2700K-6500K). Rated life of 50,000 hours at 70°C maximum driver case temperature and 100% load conditions. Typical efficiency of 86%, PF>0.9, THD<20% at 100% load conditions.

MOUNTING OPTIONS

Fixtures may be mounted to the ceiling using a threaded rod. For long runs, a minimum of 6" from adjacent walls is required.

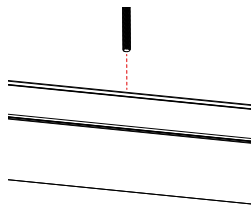
**FINISH**

Interior - 95%, reflective matte powder coated white paint

Exterior - matte white or aluminum powder coating.

Custom finishes are also available.

CONSTRUCTION

Housing - Extruded Aluminum (0.07" nominal) up to 90% Recycled Content

Interior brackets - Die formed cold rolled sheet steel 16 gauge thick

Joining system - Cold rolled steel

Reflectors - Cold rolled steel 0.024" thick precisely die formed, 95% reflective matte white painted

End caps - Aluminum plate 0.125" thickness

WEIGHT

WALO 4ft - 7.63lbs - 3.46kg

WALO 8ft - 13.78lbs - 6.25kg

WALO 12ft - 21lbs - 9.53kg

CERTIFICATIONS

ETL - Rated for Indoor Dry/Damp locations.

Conforms to UL Standard 1598 and certified to CAN/CSA Standard C22.2 No. 250.0.

WARRANTY

For all ChromaWerx products, LumenWerx provides a three-year limited warranty of electrical and mechanical performance of the luminaires, including the LED boards, drivers, and auxiliary electronics. LumenWerx will repair or replace defective luminaires or components at our discretion, provided they have been installed and operated in accordance with our specifications. Other limitations apply, please refer to the full warranty on our website.

Wall controllers are covered by the manufacturer warranty.

CHROMAWERX TUNABLE WHITE

DUO DMX SPECIFICATION

A qualified DMX integrator is required to assure proper installation and commissioning of the DMX network. **When placing the PO, please provide the contact information of your DMX integrator.**

Please answer the following questions to help us identify your DMX network requirements.

YES

Do you require a wall controller provided by Lumenwerx?

NO

DMX control system supplied by others. Lumenwerx will supply DMX-enabled fixtures with default DMX addressing. See following pages for technical DMX informations. ✓

DMX controller supplied by Lumenwerx

How many zones do you have?
A zone consists of one or more luminaires behaving identically.



1 Zone



2 Zones

How to calculate the required number of drivers:

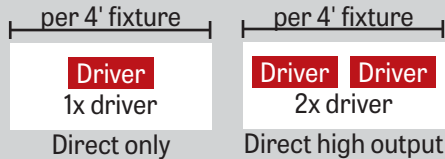

To Calculate # of drivers

1 - 4 Zones

5 or more Zones

Do you have more than 32 drivers in total?

NO

YES

Order a standard Lumenwerx wall controller.

WALL CONTROLLER

WCW - wall controller white
WCB - wall controller black

Add the control code at the end of your order code.

Please provide a fixture layout or RCP (Reflected Ceiling Plan) showing the locations of the DMX fixtures, zones and the DMX wall controller.

Refer to your DMX integrator for the installation. ✓

Subject to factory evaluation. Please contact our controls specialist at controls@lumenwerx.com Additional cost and equipment will be required. ✓

Subject to factory evaluation and approval. Please contact our controls specialist at controls@lumenwerx.com Additional cost and equipment will be required. ✓

CHROMAWERX TUNABLE WHITE

GENERIC DMX NETWORK ARCHITECTURE

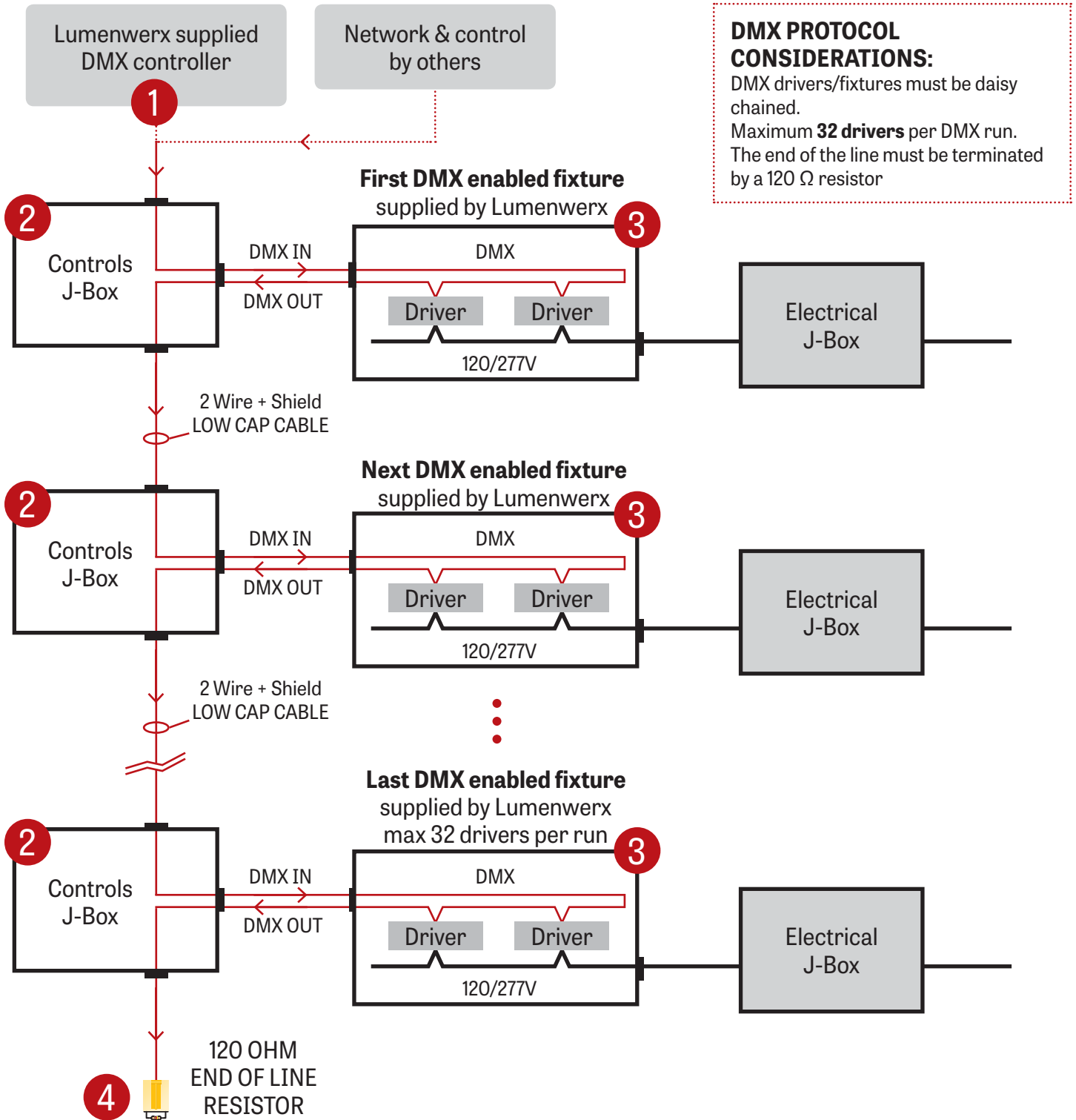

CHROMAWERX TUNABLE WHITE

1 LUMENWERX SUPPLIED DMX CONTROLLER

To the first fixture

WALL BOX SUPPLIED BY OTHERS

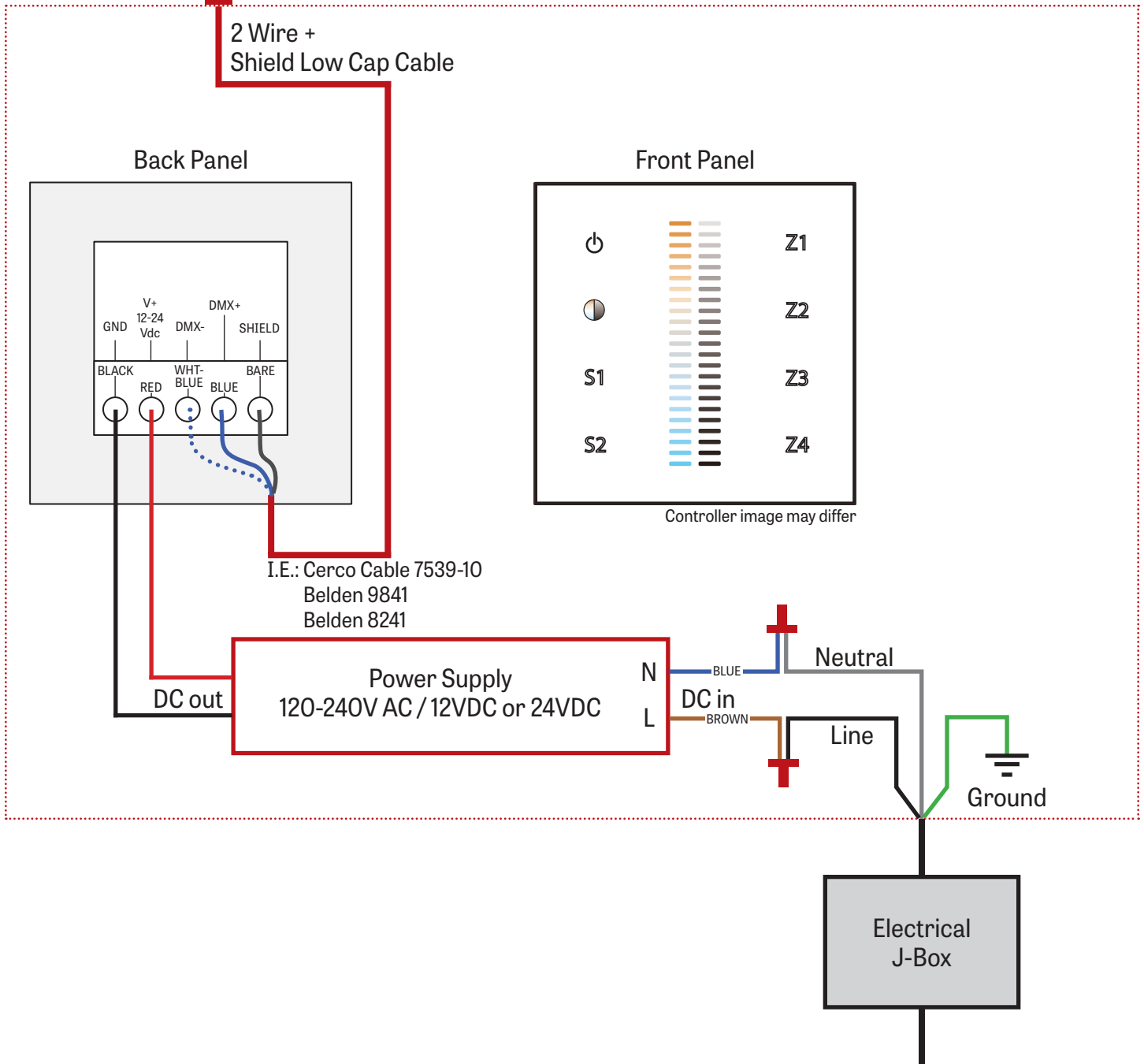

CHROMAWERX TUNABLE WHITE

2 J-BOX DMX DAISY CHAIN DETAIL

Low capacitance DMX Cable from Previous Fixture

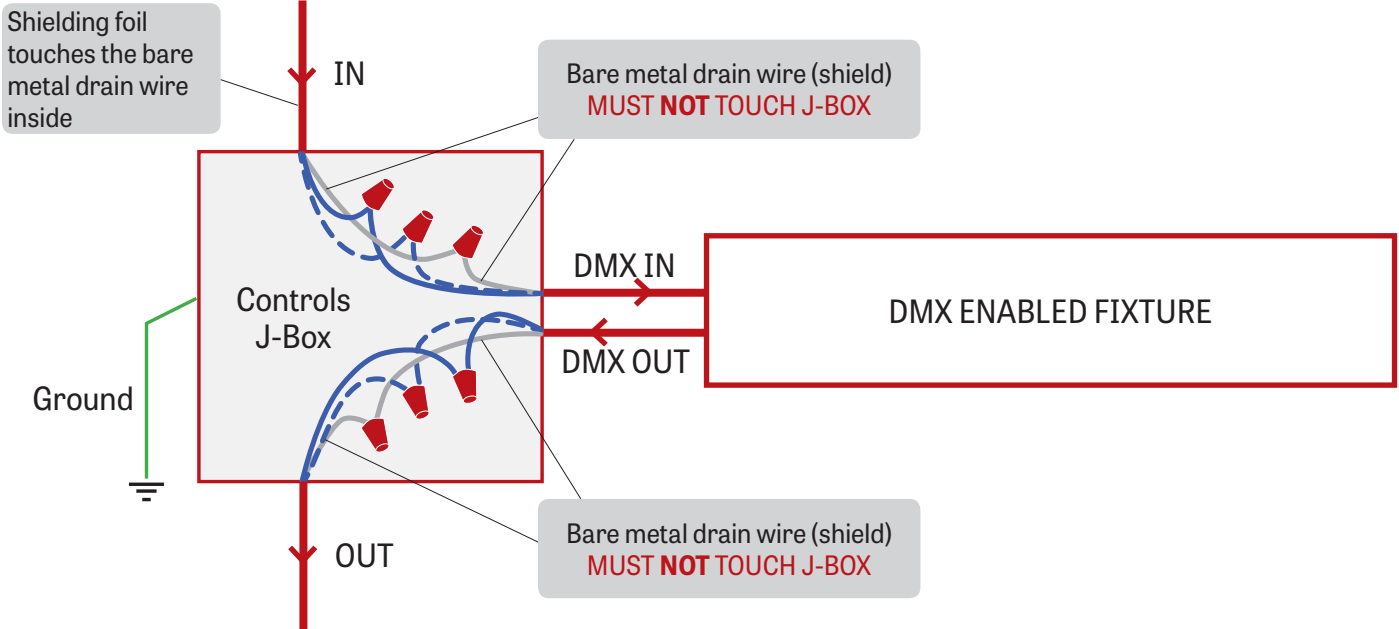

Low capacitance DMX cable to next fixture

3 DMX CONNECTION RECESSED & SURFACE

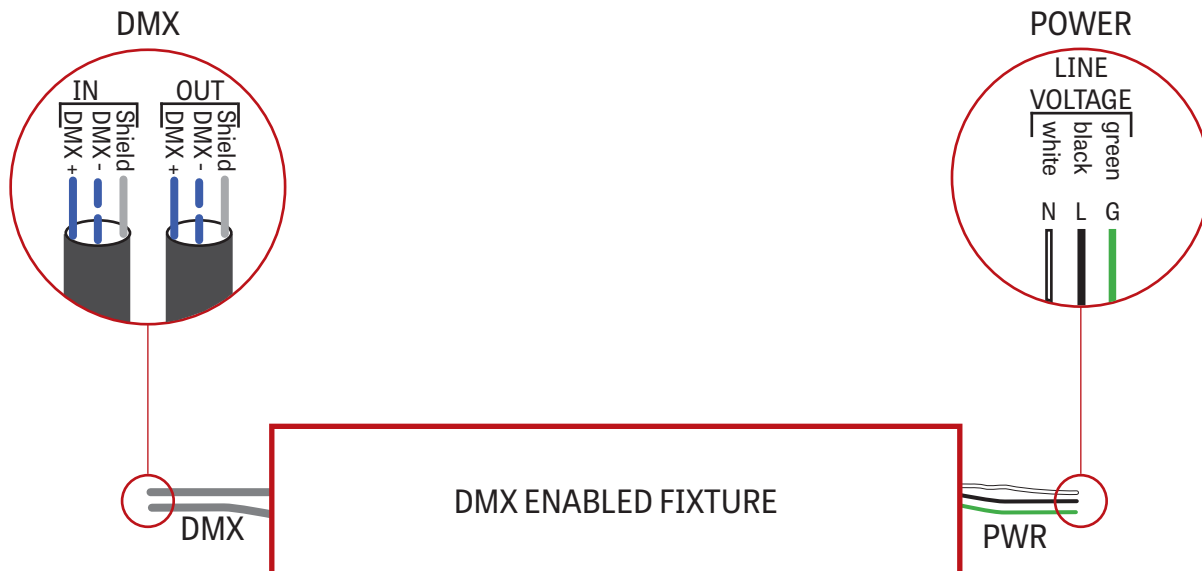

CHROMAWERX TUNABLE WHITE

DMX WALL CONTROLLER

DUO 1-4 ZONE

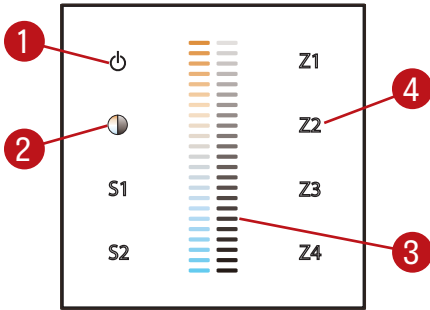

- (1) Power: Use this button to turn ON or OFF the fixture
- (2) Brightness/CCT: Use the color/brightness toggle button to chose between color/brightness. when Blue: brightness is selected, when Yellow: color is selected.
- (3) Slider: Depending on the mode chosen in 2, the slider will allow the user to set desired color or brightness.
- (4) Zone select: Up to 4 zones can be selected either independently or together. Once selected the commands will be sent to the zone identified by a Blue LED.

Default DMX Addresses:

- 1 Warm
- 2 Cool

CHROMAWERX TUNABLE WHITE AND DIM TO WARM

500 LUMEN AT 80CRI - LOW OUTPUT

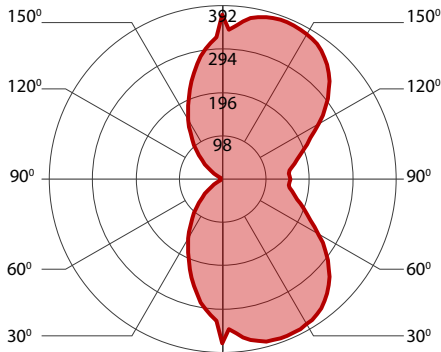

PERFORMANCE

LED output	Color Temp	Watts	Nominal Delivered Lumens	Efficacy LPW
low output	2700K	17	2000	117
low output	3000K	16.5	2000	121
low output	3500K	16.5	2000	123
low output	4000K	15.5	2000	127
low output	6500K	15	2000	132

700 LUMEN AT 80CRI - MEDIUM OUTPUT

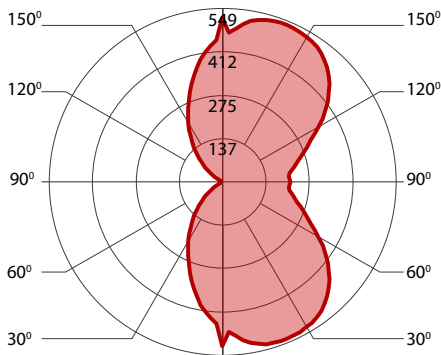

PERFORMANCE

LED output	Color Temp	Watts	Nominal Delivered Lumens	Efficacy LPW
medium output	2700K	23.5	2800	119
medium output	3000K	23	2800	123
medium output	3500K	22.5	2800	125
medium output	4000K	21.5	2800	129
medium output	6500K	21	2800	134

1000 LUMEN AT 80CRI - HIGH OUTPUT

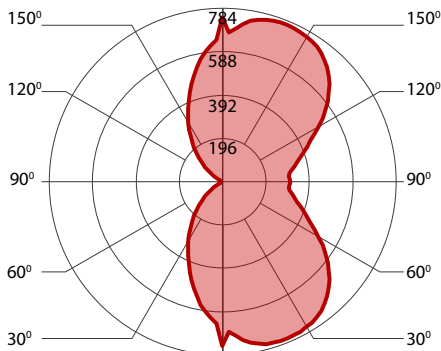

PERFORMANCE

LED output	Color Temp	Watts	Nominal Delivered Lumens	Efficacy LPW
high output	2700K	33.5	4000	120
high output	3000K	32.5	4000	124
high output	3500K	31.5	4000	126
high output	4000K	31	4000	130
high output	6500K	29.5	4000	135