

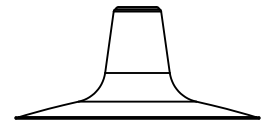

SPS-0157 REV C

STERLING SERIES

JOB NAME: _____ FIXTURE TYPE: _____



BLE - _____ - _____ - _____ - _____ - _____ - _____ - _____ - _____

A B C D E F G

_____ - _____ - _____ - _____

H I J K

Order Example: BLE - G - DCS16 - 400 - G22 - 975 - NA - CGG - 975 - FST - HDBP - E26

A - MOUNTING STYLE

C	Cord Hung
CN	Chain Hung
F	Flush Mount
G	Gooseneck
S	Stem Mount

B - SHADE SIZE**STERLING:**

DCS12	12" Shade
DCS14	14" Shade
DCS16	16" Shade

C - SHADE FINISH**PORCELAIN FINISHES¹:**

150	Black
250	White
350	Vintage Green
355	Jadite
455	Cherry Red
550	Yellow
650	Bronze
750	Cobalt Blue
765	Delphite Blue
850	Graphite
950	Metallic Chrome

POWDER COAT FINISHES²:

100	Black
105	Textured Black
106	Matte Black
200	White
206	Matte White
300	Dark Green
307	Emerald Green
311	Jadite
370	Mint
380	Chartreuse
390	Teal
400	Barn Red
420	Orange
470	Watermelon
480	Blush Pink
490	Magenta
495	Sherbet Orange
500	Buttery Yellow
570	Sunflower
600	Bronze
601	Chocolate
605	Rust
615	Oil-Rubbed Bronze
700	Royal Blue

C - SHADE FINISH (CONTINUED)**POWDER COAT FINISHES²:**

705	Navy
710	Cobalt Blue
715	Delphite Blue
790	Lavender
800	Industrial Grey
805	Charcoal Granite
810	Graphite
975	Galvanized

D - MOUNTING

Please Note: If Flush Mount [F] is selected in Section A, please select **NA**

NA	Not Applicable
-----------	----------------

CSA LISTED CORD OPTIONS:

SBK	Standard Black
SWH	Standard White
CMG	Grey Cotton
CRZ	Red Chevron
CSB	Black Cloth
CSW	White Cloth
CSR	Red Cloth
CSBB	Black & Brown Cloth
CSRW	Red & White Cloth
CSGW	Gold & White Cloth
CSBG	Black & Gold Cloth
CSBW	Black & White Cloth
CSBP	Black & Pink Cloth
CSUW	Blue & White Cloth

NON-CSA LISTED CORD OPTIONS³:

TBK	Black Cotton Twist
TWH	White Cotton Twist
TBR	Brown Cotton Twist
TRD	Red Cotton Twist
TPT	Putty Cotton Twist
TBW	Black & White Twist
TRW	Red & White Twist
TBB	Brown & Beige Twist

CHAIN MOUNT OPTIONS:

CN36	3' of Chain
CN48	4' of Chain
CN60	5' of Chain
CN72	6' of Chain

D - MOUNTING (CONTINUED)**GOOSENECK OPTIONS:**

G1	G16
G2	G17
G3⁴	G19
G4⁴	G22
G5	G24
G6	G25
G7	G26
G8	G32
G9	G34
G10	G35
G11	G36
G12	G40
G13	G64
G14	G65
G15	

STEM MOUNT OPTIONS:

ST506	.5" Stem Mount, 6"
ST512	.5" Stem Mount, 12"
ST518	.5" Stem Mount, 18"
ST524	.5" Stem Mount, 24"
ST536	.5" Stem Mount, 36"
ST548	.5" Stem Mount, 48"
ST706	.75" Stem Mount, 6"
ST712	.75" Stem Mount, 12"
ST718	.75" Stem Mount, 18"
ST724	.75" Stem Mount, 24"
ST736	.75" Stem Mount, 36"
ST748	.75" Stem Mount, 48"

E - MOUNTING FINISH

Please Note: See **Section C** for Finish Options. 980-Brushed Aluminum is also available for Gooseneck (except G36, G40, G64 & G65) and Stem mounting styles. If Porcelain Finish is selected, mounting will be powder coat painted-to-match.

(I) If Cord Hung [C] or Flush Mount [F] Mounting Style, selection identifies canopy finish

(II) If Chain Hung [CN] Mounting Style, selection identifies chain and canopy finish

(III) If Stem Mount [S] Mounting Style, selection identifies stem and canopy finish

980	Brushed Aluminum
------------	------------------

F - CORDS⁵

Please Note: See **Section D** for all applicable CSA and Non-CSA Listed Cord Options for Chain Hung Mounting Style

NA	Not Applicable
-----------	----------------

G - SHADE ACCESSORIES

NA	None
WC	Wire Cage
TGG	Heavy Duty Guard
CGG	Cast Guard
WGG	Wire Guard

H - SHADE ACCESSORY FINISH

Please Note: See **Section C** for Finish Options. If Porcelain Finish is selected, accessory will be powder coat painted-to-match

NA	Not Applicable
-----------	----------------

I - GLASS OPTION⁶

NA	Not Applicable
CLR	Clear Glass
FST	Frosted Glass
RIB	Ribbed Glass
BLU	Blue Glass
RED	Red Glass
AMB	Amber Glass
GRN	Green Glass
SMK	Smoke Crackle Glass

J - MOUNTING ACCESSORY

NA	None/Not Applicable
HSC	Hang Straight Canopy ⁷
HDSMC	Heavy Duty Stem Mount Canopy ⁷
HDBP	Heavy Duty Backing Plate ^{8,9}
DD	Dusk-to-Dawn Photocell ^{8,9}
DBPC	Decorative Backing Plate Cover ^{8,9}
DCHX	Decorative Backing Plate Cover & Hex Cover ^{8,9}

K - LIGHT SOURCE

E26	200 Watt Max
GU24	23 Watt Max ¹⁰

IMPORTANT: (1) All Porcelain Enamel finished shades feature a white interior and a black outer rim (2) All Powder Coat finished shades, Galvanized excluded, feature a white interior (3) Not available with Chain Hung option (4) Not compatible with 16" shade (5) Only applicable if Chain Hung Mounting Style selected in Section A, select NA if another Mounting Style is selected (6) Guard and Glass accessory reduces incandescent wattage to 100W Max and GU24 Bi-Pin to 18W Max (7) Only applicable if Stem Mounting Style is selected in Section A (8) Only available if Gooseneck Mounting Style is selected in Section A (9) Not available with G19 and G40 Gooseneck (10) Fixtures configured with GU24 socket are non-returnable

MOUNTING STYLE

CHAIN HUNG PENDANT (CN)

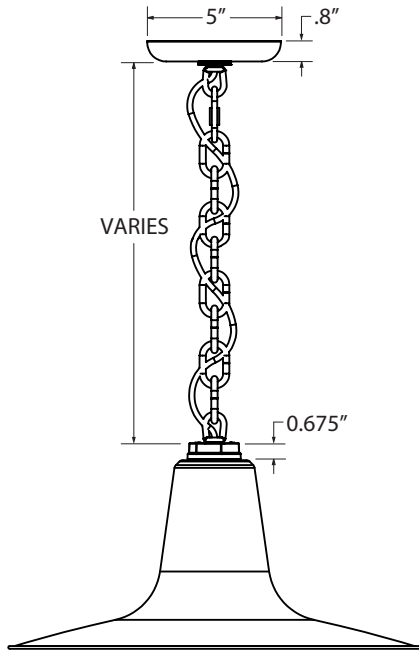

FLUSH MOUNT (F)

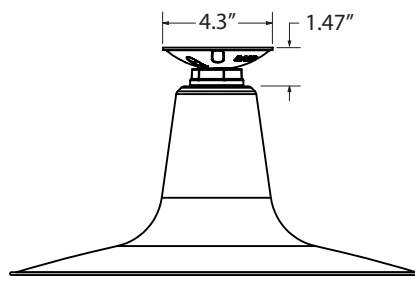

STEM MOUNT PENDANT (S)

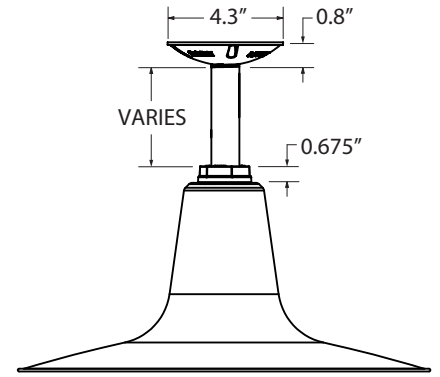

CORD HUNG PENDANT (C)

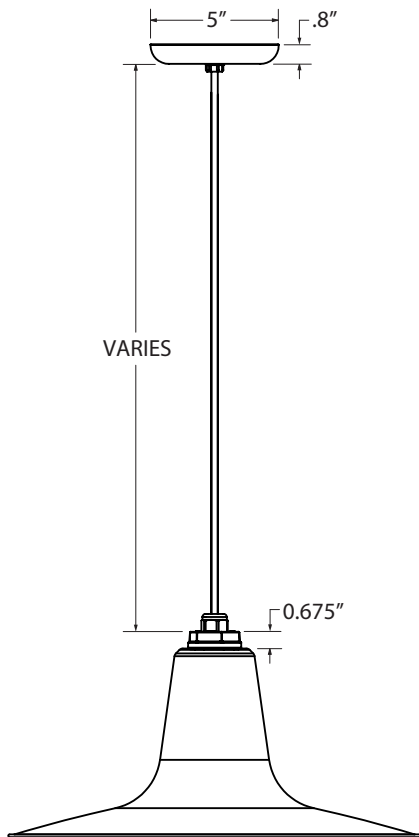

GOOSENECK (G)

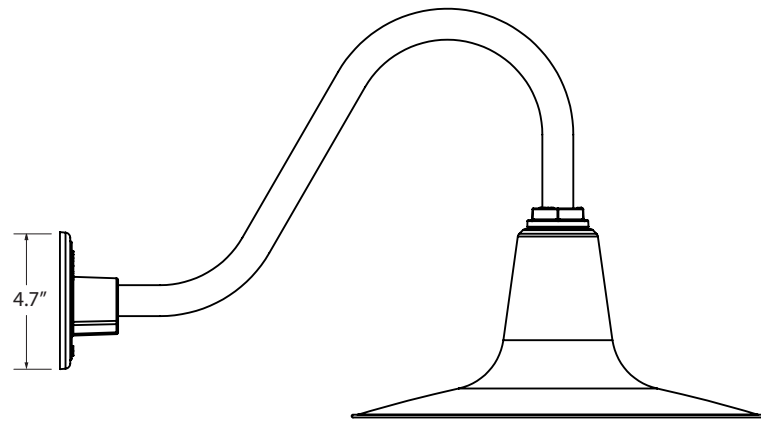

SHOWN WITH: G15 GOOSENECK ARM

LUMINAIRE DIMENSIONS

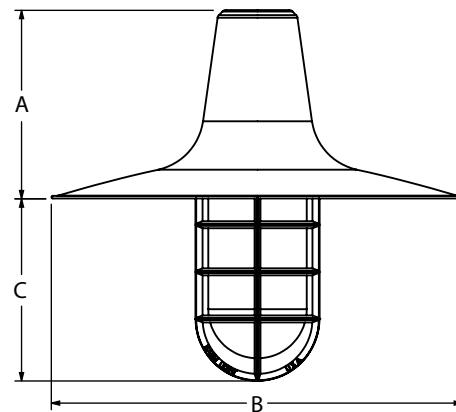

SHOWN WITH: OPTIONAL GUARD & GLASS ACCESSORY

SHADE CODE	HEIGHT (A)	DIAMETER (B)	EXTENSION (C)
DCS12	5.75"	12"	6.7"
DCS14	6.50"	14"	6.2"
DCS16	7"	16"	5.6"

SPECIFICATIONS

CERTIFICATIONS, LISTINGS & WARRANTY

MADE IN THE USA
Manufactured and Hand-Crafted in Our 60,000 Square Foot Facility
Located in Titusville, FL

CSA LISTED FOR WET LOCATIONS
Includes All Gooseneck, Stem and Flush Mounting Styles

CSA LISTED FOR DAMP LOCATIONS
Includes All Chain and Select Cord Hung Mounting Styles

LIMITED WARRANTY
For Additional Information on Our Limited Warranty, Please See
Our Terms & Conditions

UL CERTIFICATION
UL Listed Fixtures Available upon Request. Please Consult Factory
for Additional Information.

LIGHT SOURCE

INCANDESCENT
Medium Base E26 Socket, 120 VAC, 200W Max

COMPACT FLUORESCENT
Bi-Pin Base GU24 Socket, 120 VAC, 23W Max

CONSTRUCTION & FINISH

POWDER COAT SHADE
Hand-Spun from High Purity 3003-O Temper Aluminum

PORCELAIN SHADE
Hand-Spun from 20 Gauge Porcelain Steel

GALVANIZE SHADE
Hand Spun from High Quality Galvanized Steel

POWDER COAT FINISHES
Polyester Powder Coat Finishes Are Electro-Statically Applied and
Thermocured

PORCELAIN FINISHES
Applied by Hand and Fired in a High Temperature Oven

STEM
1/2" Nominal (0.84" Actual) or 3/4" Nominal (1.05" Actual) Sch 40,
6063 Aluminum Mounting Stem. Custom Lengths Available upon
Request.

GOOSENECK
1/2" Nominal (0.84" Actual) or 3/4" Nominal (1.05" Actual) Sch 40,
6063 Aluminum Gooseneck

CORD
Cord-Hung Pendants Include 7' of Standard Cord or 5' of Cotton or
Cloth Cord, +/- For Socket Orientation

CHAIN
4-Gauge Chain Complete with Quick Link for On-Site Adjustments
to Chain's Length