

Star Power Patent number: 10168023

UNMATCHED PERFORMANCE

VUE-34X @ 648 Watts achieves United States Tennis Association "Level II" 75-Foot Candle Average with less than 1.75 Maximum to Minimum Uniformity in the extended Primary Playing Area with eight fixtures spaced thirty feet apart. Designed specifically for court lighting, the VUE-34X can replace 1000 watt metal halide traditional court fixtures at 45% less energy and provide 3-4 times the existing light levels evenly across the court using the same existing fixture arms and poles. VUE-34X has a 30% or greater photometric light level advantage compared to competitors at the same wattage across the court.

GLARE & LIGHT TRESPASS SENSITIVITY

The VUE-34X fixture creates one of the most environmentally sensitive courts in the nation. VUE-34X recesses & conceals its light source 3 inches above the bottom plane of the fixture eliminating neighborhood & dark sky glare.

Player Disability Glare is significantly reduced as well, enabling players to compete at their highest level. VUE-34X is endorsed by Dr. David Crawford, Founder of the International Dark Sky Association.

TRACK RECORD

The VUE fixture is one of Americas most prolific court fixture, having been installed in over 300 of the most prestigious tennis/pickleball multi-courts around the nation.

RELIABILITY

VUE-34X is Made in America. The VUE-34X is Die Cast, 3G Vibration Rated, IP66 Rated against Dust and water, L70 Depreciation Rated at more than 130,000 hours, IK08 impact resistant, Low Iron Safety Glass Lens, 20kA Surge Protection Standard, and Powder Coated.

VUE-34X does not use Plastic Acrylic or Polycarbonate Lenses, which will yellow and cause rapid LED depreciation. Driver compartment & LEDs separate so heat from one does not depreciate the life and output of the other.

SERVICE

Cost Competitive, Supply Chain Friendly, and short Shipping Lead Times in Days & Weeks.

PRODUCT & SPECIFICATION FEATURES

- Ideal and Traditionally Designed for Tennis Clubs, Pickleball Clubs, Universities, High Schools, Residential Community Centers, Public Parks, and Private Homes
- Replaces VUE-3 & VUE-4 with 30% increased performance & better uniformity
- VUE-34X (up to 87,000 Lumens, Weight 58 lbs, EPA: 1.04) uses the patented Star Power™ Optic System for Reduced Glare and Improved Uniformity
- Optimized Sports Optic for Tennis and Pickleball
- 192L and 224L LED Configurations
- 4000K or 5000K CCT Multichip High Power 70 CRI LEDs standard
- IP66 Rated Against Dust & Water Ingress
- IK08 Rated for Impact Protection
- 20kA Surge Protection Standard (120V-480V)
- Highest quality 0-10V Programmable, Dimming LED Drivers
- Driver Compartment physically separated from LED Light Source
- Easy to Retrofit VUE-34X can slip over any existing tennis arm or bolt to any existing pole with a 1.5G to 3G Vibration Rated Mounting
- Pole, Straight Rectangular Tennis Arm, radius Davit Arm, Bolt-on Architectural Sweep Arm, Knuckle Mount, and Trunnion Mount are available with the same finish
- Ten Standard Finishes, Marine Grade Finish, and Custom Finish Available
- Available with NLS Step Dimming and Motion Sensing Controls for additional energy savings, neighborhood compliance, party atmosphere, or to maintain initial light level throughout the life of the product (Details Below)
- Die-Cast Aluminum Housing
- Environmentally Friendly Product Which Reduces Energy Consumption
- L70 Depreciation Factor > 120,000 hours (depreciates up to four times slower than import fixtures)
- Patented VUE-34X Concealed optical system is hidden from sight from neighbors, wildlife, & the dark sky and is the least glary fixture for players to compete under
- Buy America(n) VUE-34X is completely designed, fabricated, powder coated, and assembled in the USA
- *Contact Factory for custom BKGN (Black/Green) Architectural Finish
- Experienced in-house Tennis and Pickleball design team will layouts and photometric design at no charge based on USTA and National Pickleball Association Published Lighting Criteria

Project Name:

Type:

VUE-34X ORDERING GUIDE

Cat#	Light Dist.	No. of LEDs	Watts	Kelvin
VUE-34X (VUE-34X)	Type SP (SP)	192 (192L)	414W (41) 503W (50) 577W (57) 621W (62) 648W (64)	4000K, 70 CRI (40K7)Ⓢ 5000K, 70 CRI (50K7)Ⓢ
		224 (224L)	706W (70)	

Volts	Mounting	Color	CONTROLS	Options
120-277 (UNV)	Tennis Arm Mount (TA)	Bronze Textured (BRZ)	Nema 7-Pin Receptacle (PE7)	Bird Spikes (BS)
347-480 (HV)	Davit Arm Mount (DAM)	White Textured (WHT)	Receptacle + Shorting Cap (PER)	Marine Grade Finish (MGF)
	Knuckle Mount (KM)	Smooth White Gloss (SWT)	FSP-221 with Motion Sensor (120-480V) (FSP-20) *9'-20" Heights (FSP-40) *21'-40' Heights	Round Pole Adapter 3"- 4" Pole (RPA4)Ⓢ
	Trunnion Mount (TM)Ⓢ	Silver (SVR)	Motion Sensor Control FSIR-100 Remote (FSIR)Ⓢ	Round Pole Adapter 5"- 6" Pole (RPA5)Ⓢ
	Architectural Sweep Arm (ASA)	Black Textured (BLK)		Front Side Shield (FSS)
	Direct Pole 6" Arm Single, D180 (DPS6)Ⓢ	Smooth Black Gloss (SBK)		House Side Shield (HSS)
	Direct Pole 11" Arm D90, T90, T120, Quad (DPS11)Ⓢ	Graphite Textured (GPH)		
	Wall Mount (WM)	Grey Textured (GRY)		
		Green (GRN)		
		Hunter Green (HG)		
		Custom (CS)		

Notes:

- Ⓢ Standard finish is stainless steel. Can be painted to match fixture
- Ⓢ For Round Pole Specify RPA4 or RPA5
- Ⓢ Direct Pole Mount, Architectural Sweep Arm Mount only
- Ⓢ Consult Factory for other CCT options
- Ⓢ Consult Factory for Control Options
- Ⓢ One remote is required per site



701 Kingshill Place, Carson, CA 90746
Call Us Today (310) 341-2037

nslighting.com

PRODUCT SPECIFICATIONS

ELECTRICAL

- 120-277 Volts (UNV) or 347-480 Volts (HV)
- 0-10V dimming driver
- Driver power factor at maximum load is $\geq .95$, THD maximum load is 15%
- LED Drivers Ambient Temp. Min is -40°C and Ambient Temp. Max ranges from 50°C to 55°C and, in some cases, even higher. Consult the factory for revalidation by providing the fixture catalog string before quoting and specifying it.
- All internal wiring UL certified for 600 VAC and 105°C
- All drivers, controls, and sensors housed in separate IP66 compartment
- CRI 70
- Color temperature: 4000K, and 5000K available
- Surge Protection: 20kA supplied as standard.

CONSTRUCTION

- Die Cast Aluminum
- External cooling fins
- Corrosion resistant external hardware
- One-piece silicone gasket ensures IP66 seal for electronics compartment

OPTICS

Recessed Star Power™ Optical System is 95% reflective material. Utilizes a linear diffused pattern, softening the light distribution and eliminating any dark shadows or striations.

CONTROL OPTIONS

CONTROL OPTIONS & FEATURES

- FSP-221 (FSP-X) - Passive infrared (PIR) sensor providing multi-level control based on motion/daylight contribution.
- All control parameters adjustable via wireless configuration remote storing and transmitting sensor profiles.
- * Party Setting Available (10% output) Consult Factory
- * Can maintain constant foot candles over time. Consult Factory
- FSP-20 mounting heights 9-20 feet
- FSP-40 mounting heights 21-40 feet.
- Includes 5 dimming event cycles, 0-10V dimming with motion sensing, re-programmable in the field. Programmable remote must be purchased separately.
- FSIR-100 commissioning remote is required to change sensor settings. Please contact factory for ordering.

- Controls Agnostics: Please contact factory for your preferred controls option.

- NEMA 7-PIN RECEPTACLE (PE7) - An ANSI C136.41-2013 receptacle provides electrical and mechanical interconnection between photo control cell and luminaire. Dimming receptacle available two or four dimming contacts supports 0-10 VDC dimming methods or Digital Addressable Lighting Interface (DALI), providing reliable power interconnect.

- RECEPTACLE + SHORTING CAP (PER) - 7-Pin Receptacle and Shorting Cap.

OPTIONS

- BIRD SPIKES (BS) - Offer an effective and humane deterrent for larger bird species and provide a cost-effective long-term solution to nuisance bird infestations and to protect your property.

- MARINE GRADE FINISH (MGF) - A multi-step process creating a protective finishing coat against harsh environments. Chemically washed in a 5-stage cleaning system. Pre-baked, Powder coated 3-5 mils of Zinc Rich Super Durable Polyester Primer. Oven Baked. Finished Powder Coating of Super Durable Polyester Powder Coat 3-5 mil thickness.

- ROUND POLE ADAPTER (RPA) - When using round poles, specify Round Pole Adapter (RPA). Specify RPA4 when installing on 3"-4" round poles, and RPA5 when installing on 5"-6" round poles.

- House Side Shield (HSS) is designed for full property line cutoff.

- Front Side Shield (FSS) is designed to reduce glare.

FINISH

- 3-5 mils electrostatic powder coat.
- NLS Lighting standard high-quality finishes prevent corrosion, and protects against extreme environmental conditions.

WARRANTY

Five-year limited warranty for drivers and LEDs.
Consult Factory for 7 or 10 year warranty

LISTINGS

- Certified to UL 1598
- UL 8750
- CSA C22.2 No. 250.0
- IP66 Rated Fixture
- 1.5G Vibration Rated - Knuckle Mount
- 1.5G Vibration Rated - Direct Pole Mount
- 3G Vibration Rated - Trunnion Mount
- IK08 Rated
- * DLC Pending
- * USTA Approved Pending



The information and specifications on this document are subject to change without any notification. All values are design, nominal, or typical or prorated values when measured under internal and external laboratory conditions.



701 Kingshill Place, Carson, CA 90746
Call Us Today (310) 341-2037

nslighting.com

PRODUCT SPECIFICATIONS

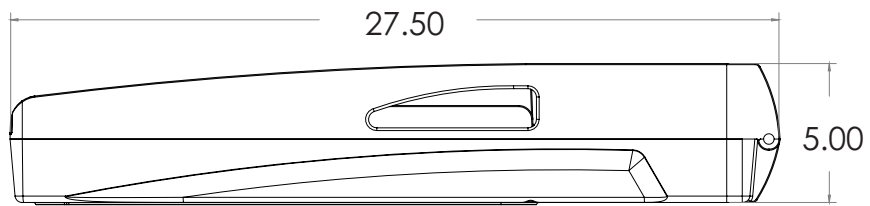
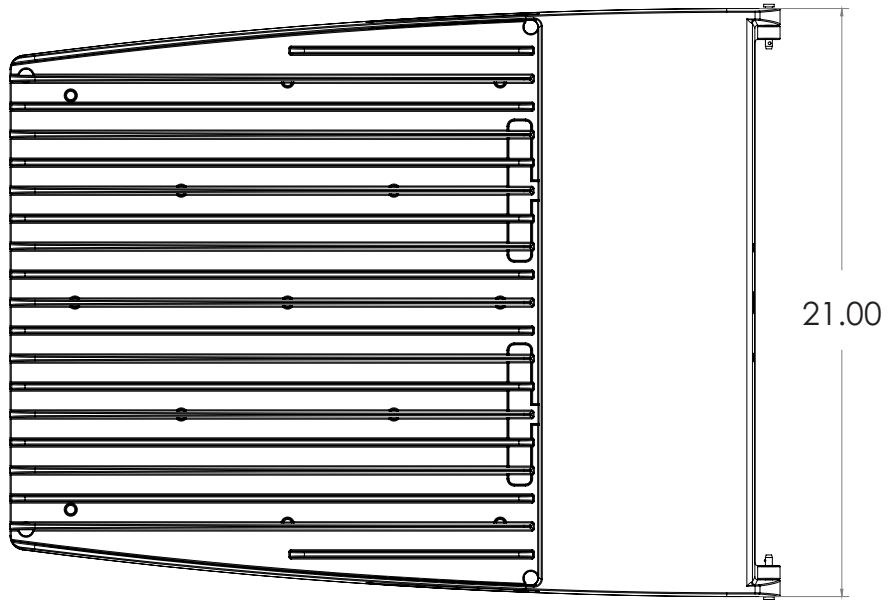

Weight: 58 lbs

PRODUCT SPECIFICATIONS

Lumens				
Part Number	SP Lumens	LM/W	BUG	Watts
VUE-34X-SP-192L-41-50K7	51159	124	B4-U0-G4	414
VUE-34X-SP-192L-50-50K7	62121	124	B4-U0-G4	503
VUE-34X-SP-192L-57-50K7	71257	124	B4-U0-G5	577
VUE-34X-SP-192L-62-50K7	76738	124	B4-U0-G5	621
VUE-34X-SP-192L-64-50K7	79041	122	B5-U0-G5	648
VUE-34X-SP-224L-70-50K7	87361	124	B5-U0-G5	706

Lumen Maintenance Data							
Ambient Temperature	Drive Current	L90 Hours*	L70 Hours**	30,000 Hours*	50,000 Hours*	60,000 Hours*	100,000 Hours**
25°C	Up to 700mA	58,000	173,000	95.7%	91.6%	89.6%	82.1%
	1050mA	43,000	117,000	93.9%	87.8%	84.9%	74.2%
*Reported extrapolations per IESNA TM-21				**Projected extrapolations per IESNA TM-21			

RECOMMENDED POLE / FIXTURE LAYOUTS

TENNIS COURT LAYOUTS

Recommended New Court Spacing
8Pole - 8Light

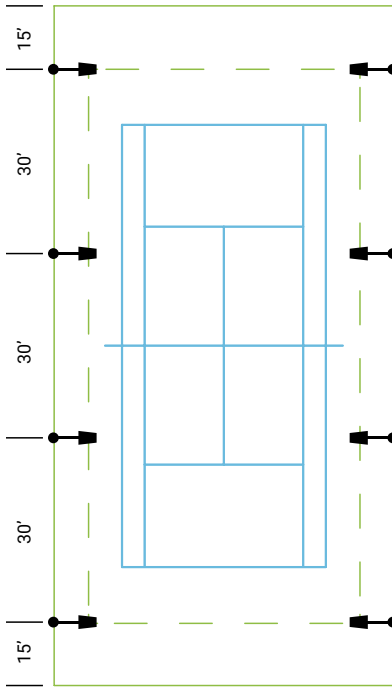

USTA Level (2) 600W
USTA Level (3) 450W

Recommended New Court Spacing
6Pole - 6Light

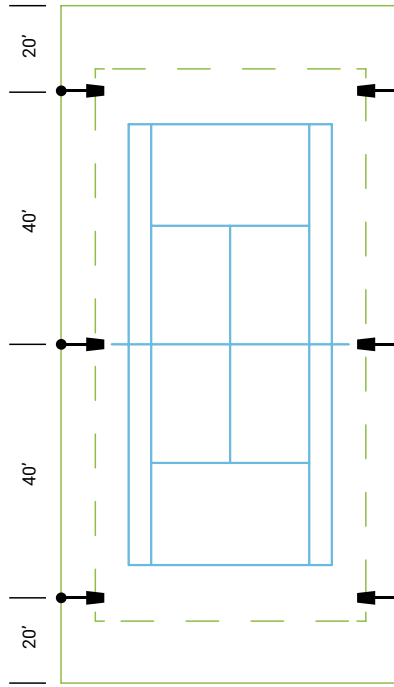

Recommended New Court Spacing
4Pole - 8Light

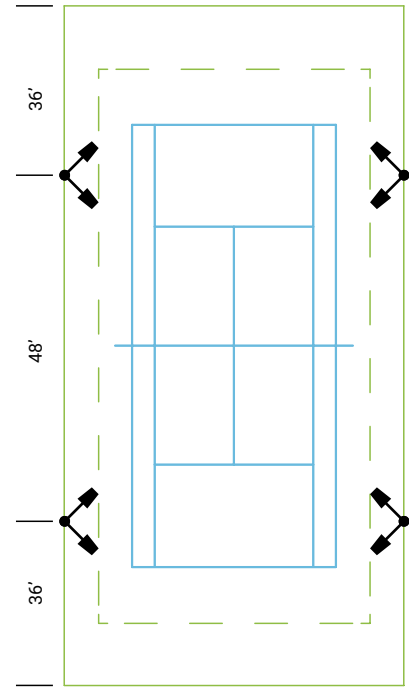

PICKLEBALL COURT LAYOUTS

Recommended New Court Spacing
4Pole - 4Light

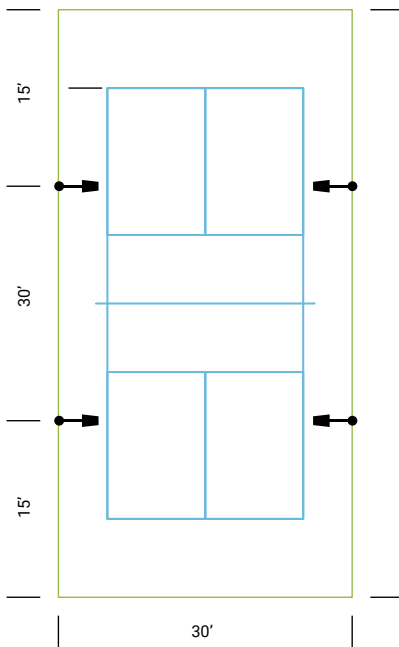



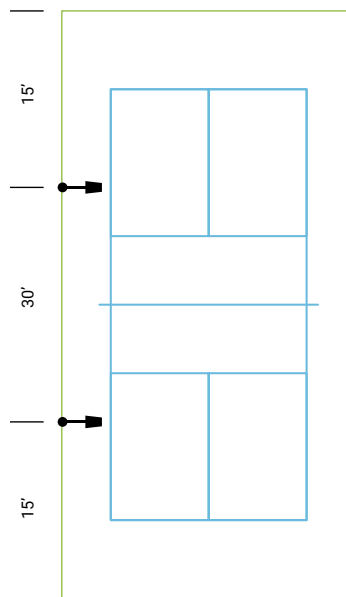





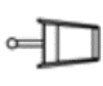

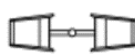

Recommended New Court Spacing
2Pole - 2Light



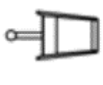





PRODUCT SPECIFICATIONS











DP VUE-34X EPA DATA











Direct Pole Mount								
SIDE	SGL	D90	D180	T90	T120	QD		
VUE-34X	1.04	1.89	2.08	2.93	2.22	2.93		
	6" DPS	11" DPS	11" DPS	6" DPS	11" DPS	11" DPS		
Total EPA (ft^2)	1.22	1.37	2.23	2.44	2.75	3.60	2.80	2.93











Direct Pole Mount								
SIDE	SGL	D90	D180	T90	T120	QD		
VUE-34X-FSS	1.28	2.67	2.56	3.95	3.03	3.95		
	6" DPS	11" DPS	11" DPS	6" DPS	11" DPS	11" DPS		
Total EPA (ft^2)	1.46	1.62	3.00	2.93	3.23	4.62	3.61	3.95

Direct Pole Mount								
SIDE	SGL	D90	D180	T90	T120	QD		
VUE-34X-HSS	1.22	3.57	2.45	4.79	4.22	4.79		
	6" DPS	11" DPS	11" DPS	6" DPS	11" DPS	11" DPS		
Total EPA (ft^2)	1.41	1.56	3.90	2.81	3.12	5.46	4.80	4.79

TA VUE-34X EPA DATA





Tennis Arm (4ft)										
SIDE	SGL	D90	D180	T90	T120	T135	Q90	Q120	U-ARM	H-ARM
VUE-34X	1.04	1.89	2.08	2.93	2.22	2.22	2.93	2.22	1.71	2.08
TA	1.40	1.40	2.80	2.80	1.40	1.07	2.80	1.40	2.80	2.80
Total EPA (ft^2)	2.44	3.29	4.88	5.73	3.62	3.29	5.73	3.62	4.51	4.88





Tennis Arm (4ft)										
SIDE	SGL	D90	D180	T90	T120	T135	Q90	Q120	U-ARM	H-ARM
VUE-34X-FSS	1.28	2.67	2.56	3.95	3.03	3.03	3.95	3.03	2.78	2.56
TA	1.40	1.40	2.80	2.80	1.40	1.07	2.80	1.40	2.80	2.80
Total EPA (ft^2)	2.68	4.07	5.36	6.75	4.43	4.10	6.75	4.43	5.58	5.36

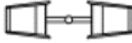



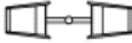

Tennis Arm (4ft)										
SIDE	SGL	D90	D180	T90	T120	T135	Q90	Q120	U-ARM	H-ARM
VUE-34X-HSS	1.22	3.57	2.45	4.79	4.22	4.22	4.79	4.22	4.69	2.45
TA	1.40	1.40	2.80	2.80	1.40	1.07	2.80	1.40	2.80	2.80
Total EPA (ft^2)	2.62	4.97	5.25	7.59	5.62	5.29	7.59	5.62	7.49	5.25

PRODUCT SPECIFICATIONS



DAVIT VUE-34X EPA DATA

Davit Arm (3ft)						
SIDE	SGL	D70	D90	D180	Q70	Q90
VUE-34X	1.04	.86	1.89	2.08	1.72	2.93
DA	.77	1.61	1.58	2.45	2.51	2.33
Total EPA (ft^2)	1.81	2.47	3.47	4.53	4.23	5.26

Davit Arm (3ft)						
SIDE	SGL	D70	D90	D180	Q70	Q90
VUE-34X-FSS	1.28	1.10	2.67	2.56	2.20	4.79
DA	.77	1.61	1.58	2.45	2.51	2.33
Total EPA (ft^2)	2.05	2.71	4.25	5.01	4.71	6.28

Davit Arm (3ft)						
SIDE	SGL	D70	D90	D180	Q70	Q90
VUE-34X-HSS	1.22	1.05	3.57	2.45	2.09	4.79
DA	.77	1.61	1.58	2.45	2.51	2.33
Total EPA (ft^2)	1.99	2.65	5.15	4.90	4.60	7.12

ASA VUE-34X EPA DATA

Architectural Sweep Arm		
SIDE	SGL	D180
VUE-34X	1.22	2.45
ASA	.27	.53
Total EPA (ft^2)	1.49	2.98

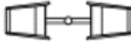
Architectural Sweep Arm		
SIDE	SGL	D180
VUE-34X-FSS	1.28	2.56
ASA	.27	.53
Total EPA (ft^2)	1.55	3.09

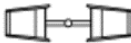
Architectural Sweep Arm		
SIDE	SGL	D180
VUE-34X-HSS		
ASA	.27	.53
Total EPA (ft^2)		

MOUNTING OPTIONS

TENNIS ARM MOUNT (TA)

Steel fitter slips over 3.5" x 1.5" rectangular arm.

**See Tennis Arm Spec Sheet for details*

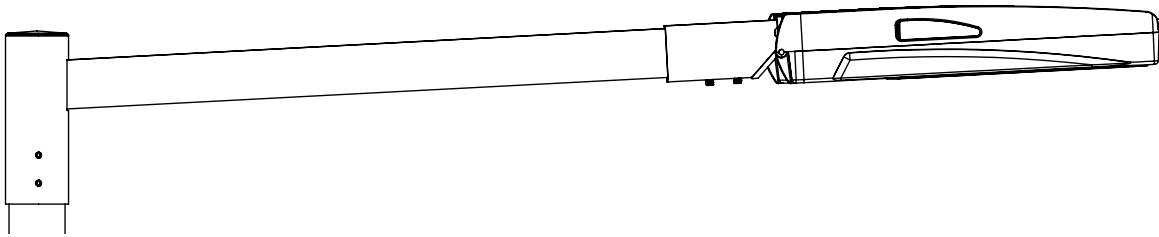
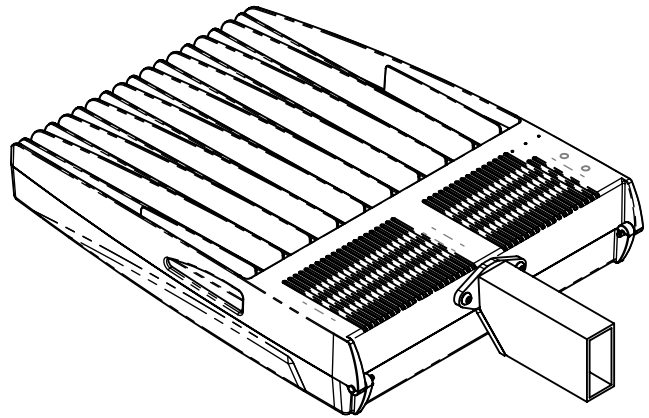
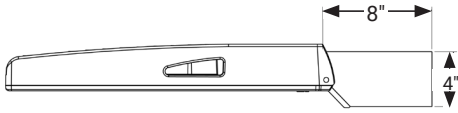

DAVIT ARM MOUNT (DAM)

Steel fitter slips over 4" O.D.

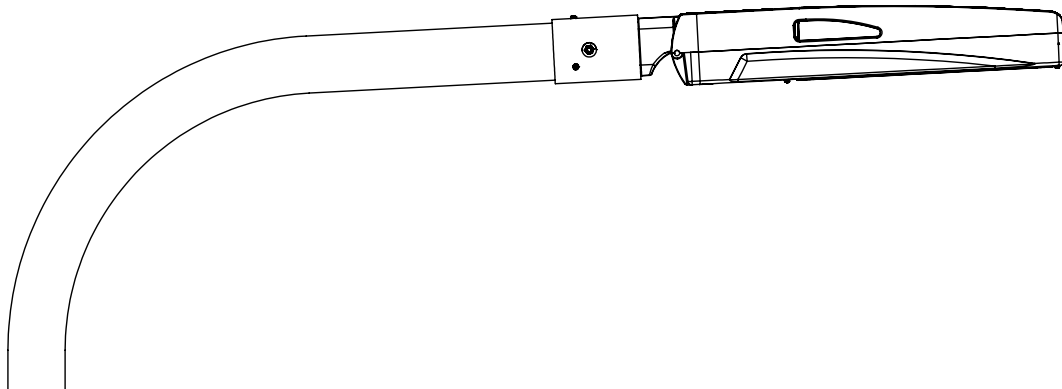
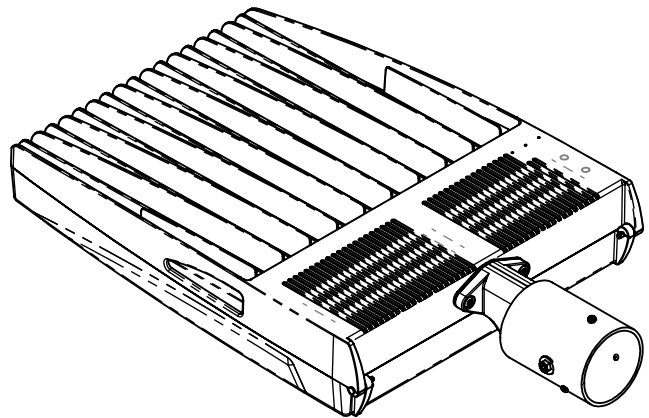

MOUNTING OPTIONS

ARCHITECTURAL SWEEP ARM (ASA)

Cast Sweep Arm includes (as standard)
Internal Quick Mount Bracket.

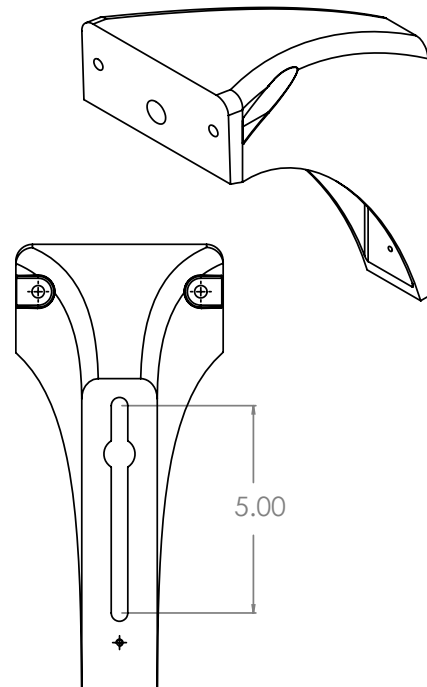
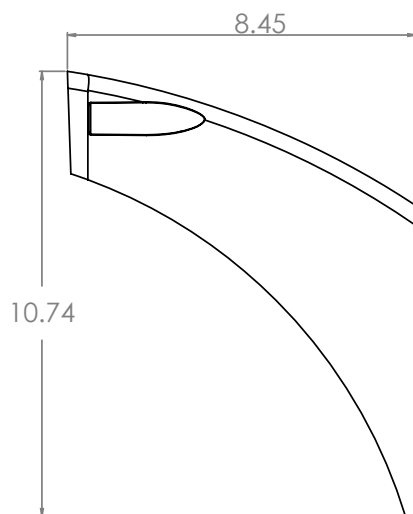
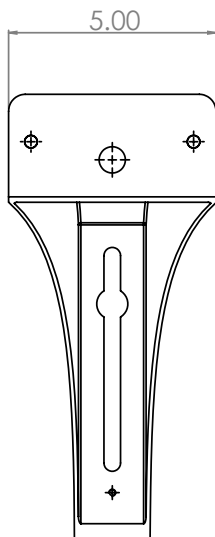
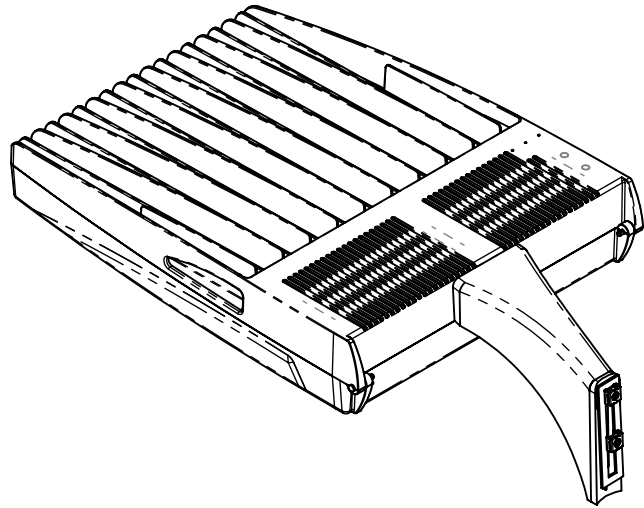
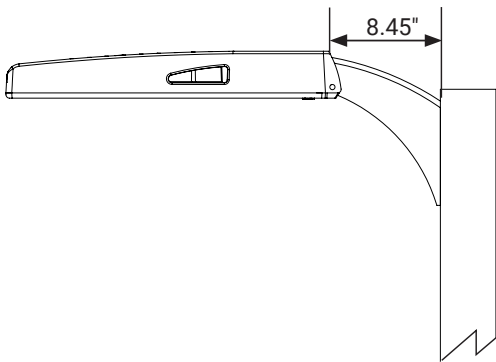

MOUNTING OPTIONS

KNUCKLE MOUNT (KM)

Die Cast Knuckle great for adjustable installation on 2-3/8" OD vertical or horizontal tenon.

- Max Uplift of 70 degrees
- Adjustable in 6 degree increments

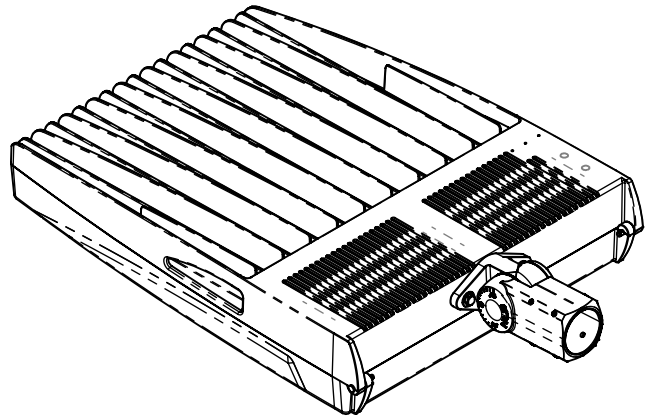
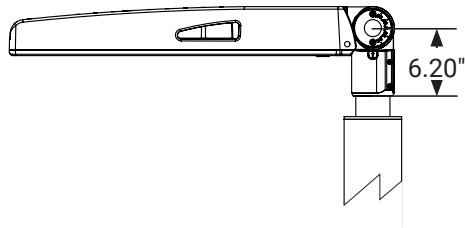

TRUNNION MOUNT (TM)

Steel, bolt-on-mounting for adjustable installation with a maximum uplift of 70 degrees.

**Unpainted stainless steel is standard*

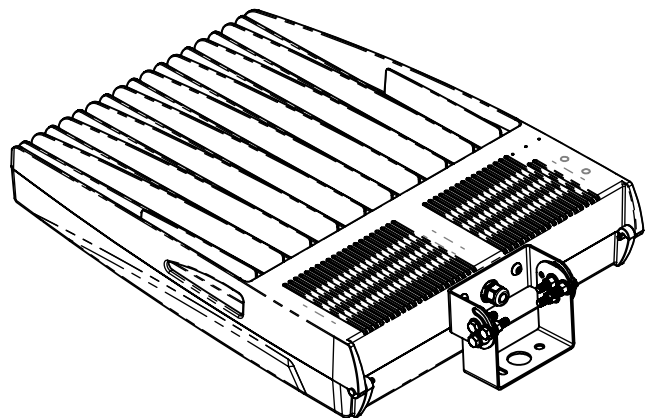
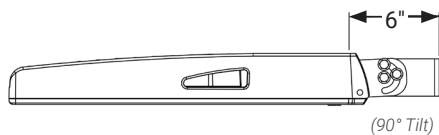

MOUNTING OPTIONS

DIRECT POLE (DP)

Standard mounting arm is extruded aluminum in lengths of 6.25" and 11.25".
**Arm lengths may vary depending on configuration*

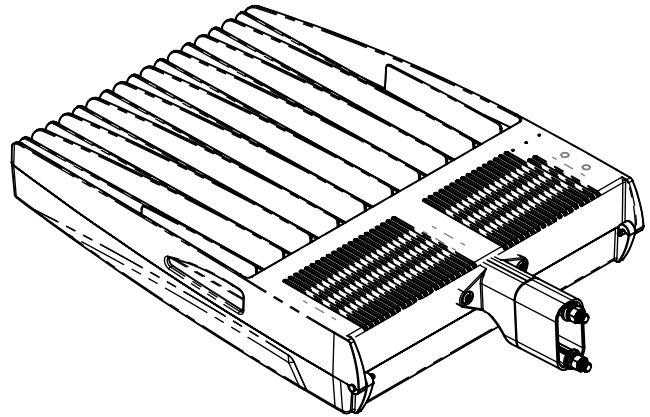
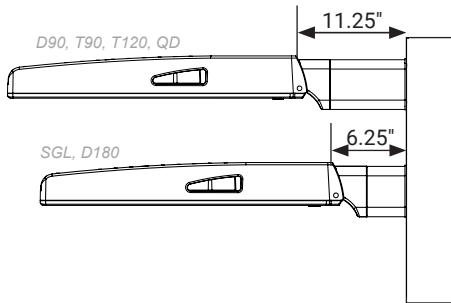

WALL MOUNT (WM)

Cast Aluminum Plate for direct wall mount. 3" extruded aluminum arm mounts directly to a cast wall mount box.

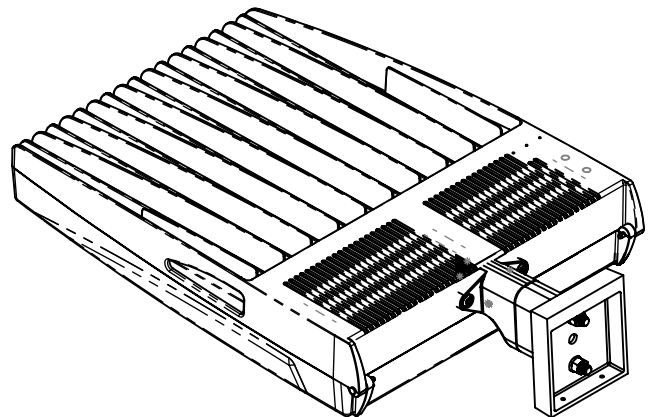
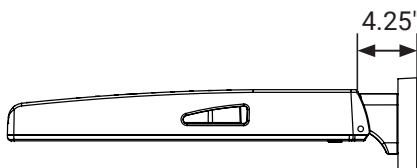

BIRD SPIKES (BS)

Bird Deterrent offers effective and humane deterrent for larger bird species and provides cost-effective long-term solution to nuisance bird infestations and protect your property.

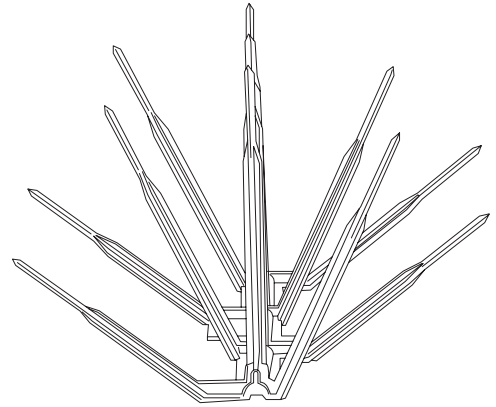

MARINE GRADE FINISH (MGF)



Powder Coat Finish

3-5mm Powder Coat

Primer Layer

3-5mm Zinc Rich
Super Durable Polyester Primer

Prepared Casting

Chemically washed in multi Step 5 stage
cleaning process

Marine Grade Finish (MGF)

The **(MGF)** is a multi step process. Chemically washed in a 5 stage cleaning system. Pre-baked. Powder coated 3-5 mils of Zinc Rich Super Durable Polyester Primer. Oven Baked.

Finished Powder Coating of Super Durable Polyester Powder Coat 3-5 mil thickness.

NEMA 7-PIN RECEPTACLE (PE7)

An ANSI C136.41-2013 receptacle provides electrical and mechanical interconnection between photo control cell and luminaire. Dimming receptacle available two or four dimming contacts supports 0-10 VDC dimming methods or Digital Addressable Lighting Interface (DALI), providing reliable power interconnect.

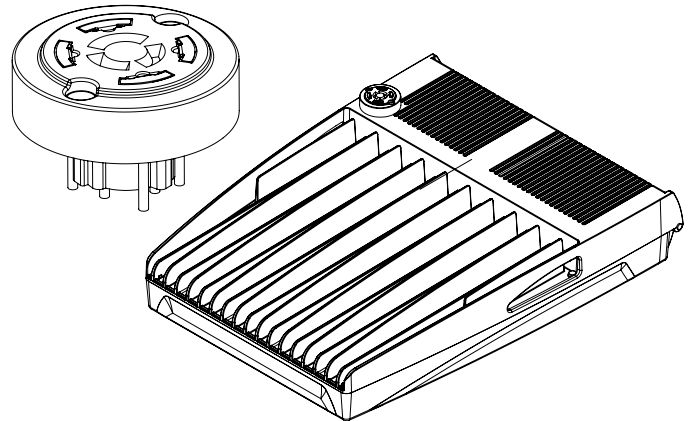

RECEPTACLE + SHORTING CAP (PER)

7-Pin Receptacle and Shorting Cap.

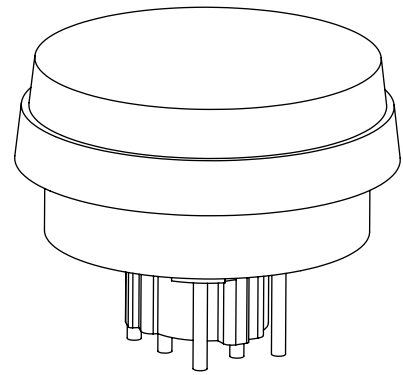

ROUND POLE ADAPTER OPTIONS (RPA4) (RPA5)

When using round poles, specify Round Pole Adapter (RPA). Specify RPA4 when installing on 3"-4" round poles, and RPA5 when installing on 5"-6" round poles.

RPA4 / RPA5

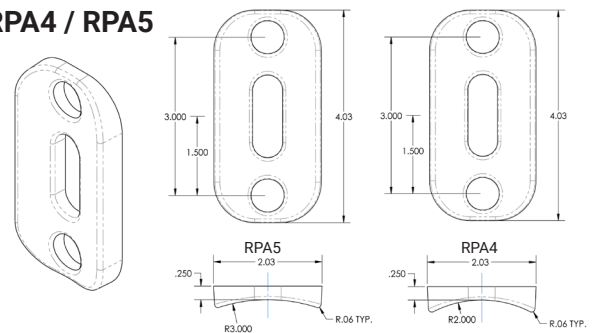

LED KELVIN

4000K or 5000K, is the ideal color temperature range for Tennis / Pickleball applications. The brightness is several times higher than traditional HID, also you can save up to 50-80% energy consumption and provide farther irradiation distance with more focused lighting with less fixtures.

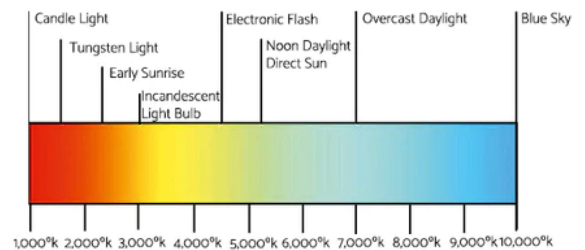
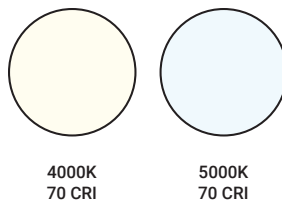

FSP-221 WITH MOTION SENSOR (FSP-XX)

- FSP-221 (FSP-X)—Passive infrared (PIR) sensor providing multi-level control based on motion/daylight contribution.
- All control parameters adjustable via wireless configuration remote storing and transmitting sensor profiles.
- FSP-20HV mounting heights 9-20 feet
- FSP-40HV mounting heights 21-40 feet.
- Includes 5 dimming event cycles, 0-10V dimming with motion sensing, re-programmable in the field.
- FSIR-100 commissioning remote is required to change sensor settings. Please contact factory for ordering.

FSP-221

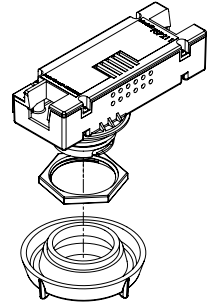

FSP-20HV

Coverage Top View @ 20 ft.

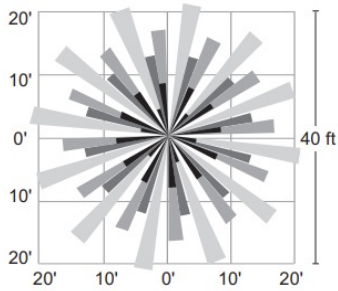

Coverage Side View

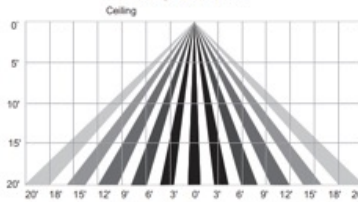

FSP-40HV

Coverage Top View @40ft

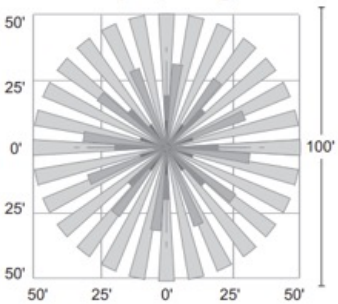

Coverage Side View

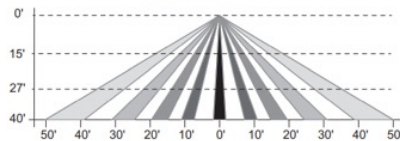

Sensor Specification



HOUSE SIDE SHIELD (HSS)

Full cutoff shield to block the light from illuminating a residence or other structure being protected from light trespass.

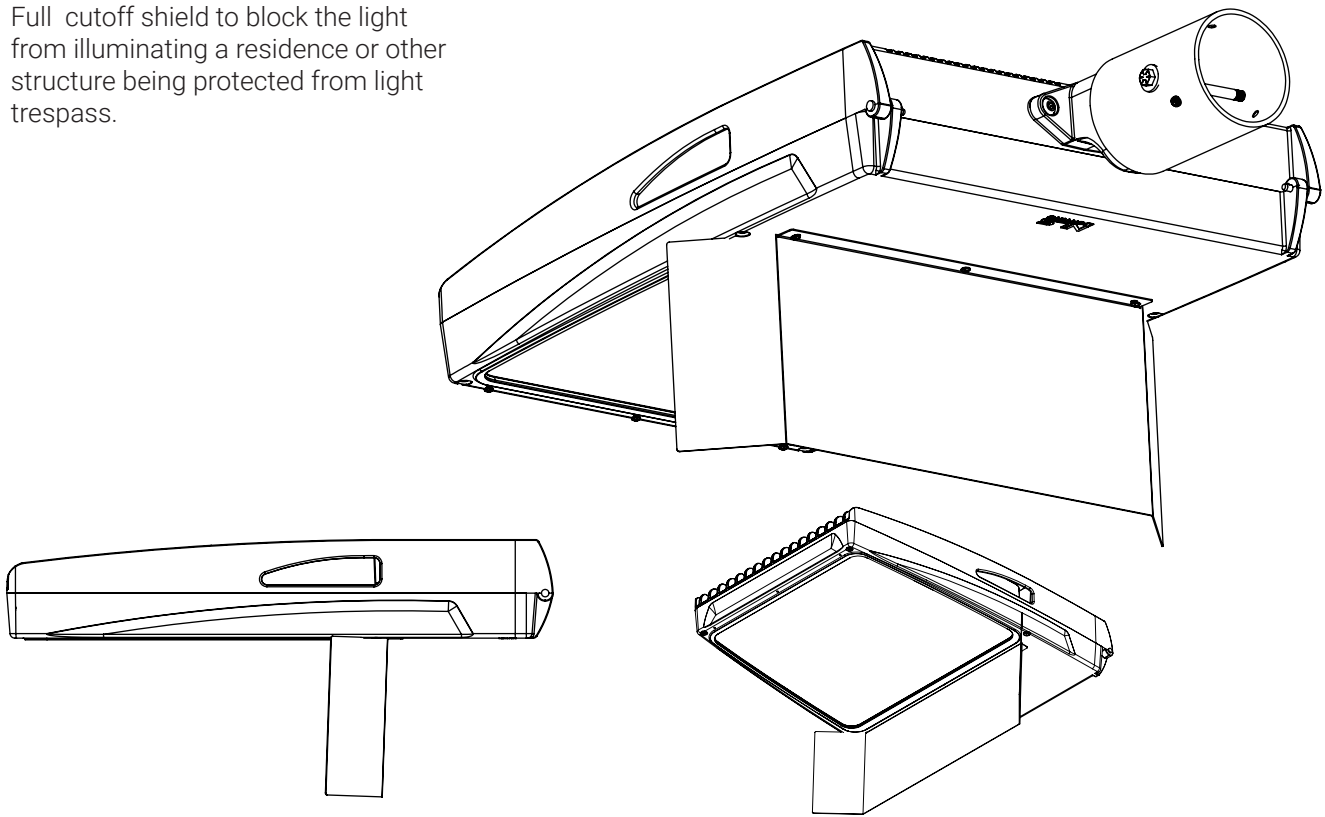

FRONT SIDE SHIELD (FSS)

Front side glare shield.

