

## PRIME 4" LED ARCHITECTURAL ROUND FLANGELESS WALL WASH WITH WARMDIM



WARM: DIM

### USE OF PRODUCT

The 4" Prime Wall Wash Series of downlight is the ideal product for energy efficient lighting in commercial and residential applications where wall washing is required. Available in an assortment of color temperatures, optics, lumen outputs, and dimmable driver options.

### LED ENGINE

LED engine available with Warm-Dim standard 90+ CRI. 2 Step MacAdam ellipse allows for color consistency between fixtures. LED mounted to aluminum heat sink for maximum life output and thermal management. Light engine provides a quick disconnect with locking strain relief to housing.

### FRAME CONSTRUCTION

Constructed from 16 gauge heavy duty powder coated cold rolled steel frame with a large access junction box.

### ADJUSTMENT

- Light engine locked at 25° tilt, consult factory for other tilt setting.
- Housing provides for 360° locking rotation
- Aperture collar adjusts 15°± horizontally within frame for square ceiling alignment
- Collar notch allows for easy alignment for square applications.
- Aperture collar compatible up to 1½" ceiling thickness.
- Accommodation for 2" or 3" ceiling thickness available upon request.

### OPTICS

Field replaceable optical lens available in 18°, 30°, 50°, and 80°. Easily achieve narrow spot to wide flood beam pattern. Option for frosted, honeycomb, or solite filter (2 maximum).

### DIMMING

Available in 8 driver selections. (ID) Standard all-inclusive ELV, Triac, and 0-10V dimming driver called Intelligent Drive, 120-277V. (PEQ0) Lutron Hi-Lume Premier Ecosystem 0.1% w/soft on, fade to black dimming, 120-277V. (LDE1) Lutron Hi-Lume 1% Ecosystem with soft on, fade to black dimming, 120-277V. (LTE) Lutron Hi-Lume 1% 2-wire, 120V. (L3DA) Hi-lume 1% EcoSystem/3-Wire L3D Driver (EEI) eldoLED Eco 1% Dim (0-10V), 120-277V. (EDIO) eldoLED Solo 0.1% Dim(0-10V), 120-277V. (EDID) eldoLED Solo 0.1% Dim(DALI), 120-277V.

### THERMAL MANAGEMENT

Ambient temperatures at fixture location should not exceed  
-20° to 40°C.

### EMERGENCY BATTERY

Optional emergency battery available for a minimum of 90 minutes with both integral or remote test switch in 800 or 1700 delivered lumens.

### TRIM OPTIONS

- All trims are self flanged die cast or anodized.
- Trim includes standard frosted acrylic diffuser.
- 12% lumens increase if remove standard frosted acrylic diffuser in field.
- Optical Enhancer reflects light evenly across the diffusion lens.
- Trims available in round or square in an assortment of standard or made to order finishes.

### LABELS/COMPLIANCE/WARRANTY

- CSA Listed for US and Canada
- Dry/Damp/Wet location rated.
- 5 Year limited warranty



## ORDERING INFORMATION

Series	Aperture Size	Lumens	Color Temperature	Voltage	Dimming	Optical Lens	Filter
RPA	4 - 4"	9L - 975 lm	WD - Warm Dim	UNV - 120-277	ID <sup>1</sup> Standard all-inclusive ELV, Triac, and 0-10V dimming driver (Intelligent Drive)	18 - 18°	None - Leave blank
PRIME Series		11L - 1100 lm		120 - 20V 347 - 347V	PEQ0 Lutron Hi-Lume Premier Ecosystem 0.1% w/soft on, fade to black dimming	30 - 30°	F - Frosted filter
					LDE1 Lutron Hi-Lume 1% Ecosystem with soft on, fade to black dimming	50 - 50°	H - Honey comb
					LTE <sup>2</sup> Lutron Hi-Lume 1% 2-wire	80 - 80°	S - Solite filter
					L3DA Hi-lume 1% EcoSystem/3-Wire L3D Driver		
					EEI <sup>3,4</sup> eldoLED Eco 1% Dim (0-10V)		
					EDIO <sup>3,4</sup> eldoLED Solo 0.1% Dim (0-10V)		
					EDID <sup>3,4</sup> eldoLED Solo 0.1% Dim (DALI)		

Housing Type	Aperture	Frame Accessories	Collar	Options
NC - Non-IC New Construction	RLWP - Round Flangeless Wall Wash Plaster	C - C-Channel bar hanger	Blank - 1.5" Depth	EI8 - Emergency battery with integral switch(800 Lumens)
IC - Air-tight New Construction	RLWM - Round Flangeless Wall Wash Milwork	B - Flat bar hanger	20 - 2" Depth	ER8 - Emergency battery with remote switch (800 Lumens)
			30 - 3" Depth	EI17 - Emergency battery with integral switch(1700 Lumens)
			MTO - Made to order	ER17 - Emergency battery with remote switch (1700 Lumens)
				FCJS-E - Vive wireless individual controller(Ecosystem)
				FCJS-0 - Vive wireless individual controller(0-10)
				CP - Chicago Plenum

## TRIM ORDERING INFORMATION

Aperture Size / Shape / Trim Type / Style	Bevel Finish	Options
4RLA - 4" Round Flangeless Accent	W - White B - Black H - Haze S - Specular clear WE - Wheat MTO - Made to order	WL - Wet Location

1. Intelligent Drive is the standard driver.  
2. 120V only.  
3. Must specify logarithmic or linear eldoLED diver.  
4. Confirm dimming curve: linear or logarithmic.

## LUMEN CHART

Wattage	Delivered Lumens	Voltage	CRI
10W	975 lm	120 - 277V	90+
12W	1100 lm	120 - 277V	90+

## TRIM DIMENSION

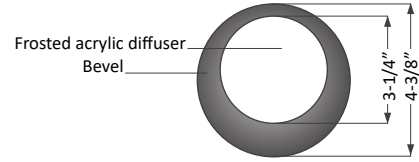
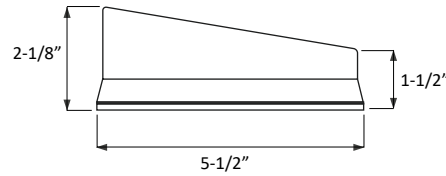

## LED HOLDER & FILTER DIMENSION

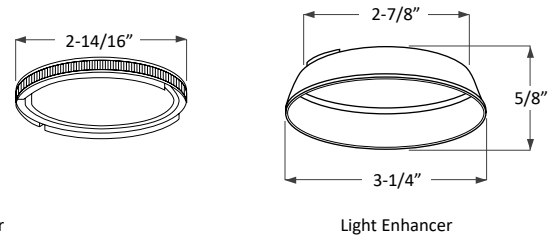
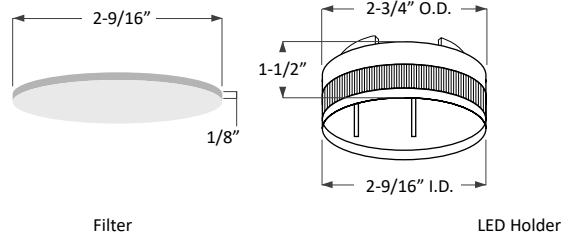

## HOUSING DIMENSION



NC - Non-IC New Construction

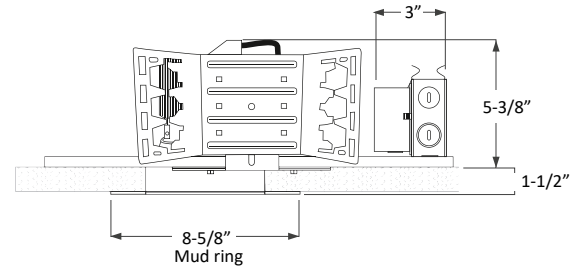
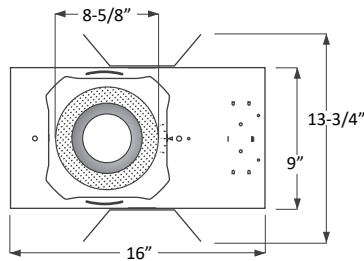

IC - Air-tight New Construction

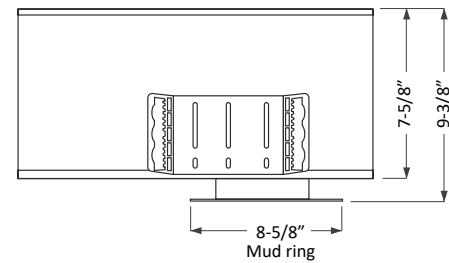
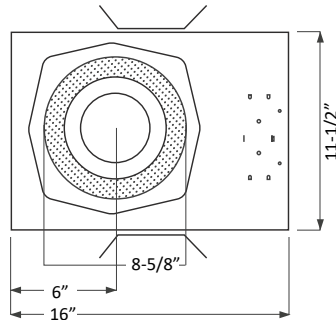

## COLLAR DEPTH PER CEILING THICKNESS

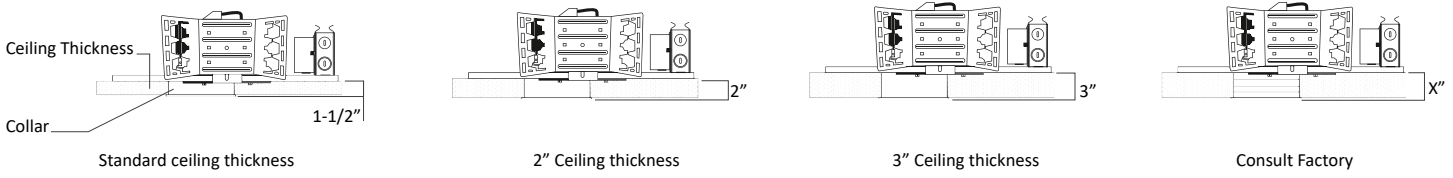

## FRAME ACCESSORIES

