

PRIME 4" LED ARCHITECTURAL SQUARE FLANGELESS DOWNLIGHT



USE OF PRODUCT

The 4" Prime Downlight Series is the ideal product for architectural energy efficient lighting in commercial and residential applications. Available in an assortment of color temperatures, optics, lumen outputs, and dimmable driver options.

LED ENGINE

LED engine available with CREE LEDs in 2700K, 3000K, 3500K, or 4000K in standard 93+ CRI. 2 Step MacAdam ellipse allows for color consistency between fixtures. LED mounted to aluminum heat sink for maximum life output and thermal management. Light engine provides a quick disconnect with locking strain relief to housing.

FRAME CONSTRUCTION

Constructed from 16 gauge heavy duty powder coated cold rolled steel frame with a large access junction box.

ADJUSTMENT

- Housing provides for 360° locking rotation
- Aperture collar adjusts 15°± horizontally within frame for square ceiling alignment
- Collar notch allows for easy alignment for square applications.

- Aperture collar compatible up to 1½" ceiling thickness.
- Accommodation for 2" or 3" ceiling thickness available upon request.

OPTICS

Field replaceable optical lens available in 18°, 30°, 50°, and 80°. Easily achieve narrow spot to wide flood beam pattern. Option for frosted, honeycomb, or solite filter (2 maximum).

DIMMING

Available in 8 driver selections. (ID) Standard all-inclusive ELV, Triac, and 0-10V dimming driver called Intelligent Drive, 120-277V. (PEQ0) Lutron Hi-Lume Premier Ecosystem 0.1% w/soft on, fade to black dimming, 120-277V. (LDE1) Lutron Hi-Lume 1% Ecosystem with soft on, fade to black dimming, 120-277V. (LTE) Lutron Hi-Lume 1% 2-wire, 120V. (L3DA) Hi-lume 1% EcoSystem/3-Wire L3D Driver (EEI) eldoLED Eco 1% Dim (0-10V), 120-277V. (EDIO) eldoLED Solo 0.1% Dim (0-10V), 120-277V. (EDID) eldoLED Solo 0.1% Dim (DALI), 120-277V.

THERMAL MANAGEMENT

Ambient temperatures at fixture location should not exceed -20° to 40°C.

EMERGENCY BATTERY

Optional emergency battery available for a minimum of 90 minutes with both integral or remote test switch in 800 or 1700 delivered lumens.

TRIM OPTIONS

- All trims are self flanged die cast or anodized.
- Trim includes standard frosted acrylic diffuser.
- 12% lumens increase if remove standard frosted acrylic diffuser in field.
- Optical Enhancer reflects light evenly across the diffusion lens.
- Trims available in round or square in an assortment of standard or made to order finishes.

LABELS/COMPLIANCE/WARRANTY

- CSA Listed for US and Canada
- Energy Star
- Dry/Damp/Wet location rated.
- Title 24, JA8 Compliant
- 5 Year limited warranty



ORDERING INFORMATION

RPA — Aperture Size — Lumens — Color Temperature — Voltage — Dimming — Optical Lens — Filter — Housing Type — Aperture — Filter — Frame Accessories — Collar — Option

Series	Aperture Size	Lumens	Color Temperature	Voltage	Dimming	Optical Lens	Filter
RPA	4 - 4"	10L¹ - 1035 lm	27 - 2700K	UNV - 120-277	ID³ Standard all-inclusive ELV, Triac, and 0-10V dimming driver (Intelligent Drive)	18 - 18°	None - Leave blank
PRIME Series		12L¹ - 1280 lm	30 - 3000K	120 - 20V	PEQ0⁴ Lutron Hi-Lume Premier Ecosystem 0.1% w/soft on, fade to black dimming	30 - 30°	F - Frosted filter
		16L¹ - 1625 lm	35 - 3500K	347² - 347V	LDE1⁵ Lutron Hi-Lume 1% Ecosystem with soft on, fade to black dimming	50 - 50°	H - Honey comb
		21L¹ - 2115 lm	40 - 4000K		LTE^{5,6} Lutron Hi-Lume 1% 2-wire	80 - 80°	S - Solite filter
		24L¹ - 2480 lm			L3DA Hi-lume 1% EcoSystem/3-Wire L3D Driver		
		31L - 3100 lm			EEI^{6,7,8} eldoLED Eco 1% Dim (0-10V)		
		34L - 3430 lm			EDIO^{5,7,8} eldoLED Solo 0.1% Dim (0-10V)		
		39L - 3965 lm			EDID^{6,7,8} eldoLED Solo 0.1% Dim (DALI)		

Housing Type	Aperture	Frame Accessories	Collar	Options
NC - Non-IC New Construction	SLDP - Square Flangeless Downlight Plaster	C - C-Channel bar hanger	Blank - 1.5" Depth	EI8 - Emergency battery with integral switch(800 Lumens)
IC¹⁰ - Air-tight New Construction	SLDM - Square Flangeless Downlight Milwork	B - Flat bar hanger	20 - 2" Depth	ER8 - Emergency battery with remote switch (800 Lumens)
			30 - 3" Depth	EI17 - Emergency battery with integral switch(1700 Lumens)
			MTO - Made to order	ER17 - Emergency battery with remote switch (1700 Lumens)
				FCJS-E - VIVE wireless individual controller(Ecosystem)
				FCJS-0 - VIVE wireless individual controller(0-10)
				CP¹⁰ - Chicago Plenum

TRIM ORDERING INFORMATION

Aperture Size / Shape / Trim Type / Style	Bevel Finish	Options
4SLO - 4" Square Flangeless Open	W - White	WL - Wet Location
	B - Black	
	H - Haze	
	S - Specular clear	
	WE - Wheat	
	MTO - Made to order	

1. Compatible with IC new construction housing.
2. Step down transformer required.
3. Intelligent Drive is the standard driver.
4. Driver must not exceed 1625 lm
5. 120V only.
6. Inapplicable to 3965 Lumen offering.
7. Must specify logarithmic or linear eldoLED diver.
8. Confirm dimming curve: linear or logarithmic.
9. Without standard frosted acrylic diffuser.
10. Compatible up to 2115 lumens.

LUMEN CHART

Wattage	Delivered Lumens	Voltage	CRI
11W	1035 lm	120 - 277V	93+
16W	1280 lm	120 - 277V	93+
20W	1625 lm	120 - 277V	93+
30W	2115 lm	120 - 277V	93+
31W	2480 lm	120 - 277V	93+
38W	3100 lm	120 - 277V	93+
45W	3430 lm	120 - 277V	93+
58W	3965 lm	120 - 277V	93+

MULTIPLIERS

Color Temperature	Lumen Multiplier
2700K	0.93
3000K	1.00
3500K	1.07
4000K	1.15

*Above chart, ordering information, and IES File name reflect delivered lumens based 3000K and 30° optical lens.
 **Lumens will vary based on CCT, optical lens, and bevel finish.

TRIM DIMENSION

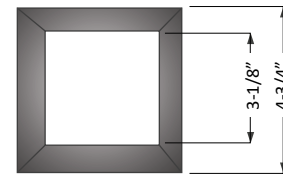
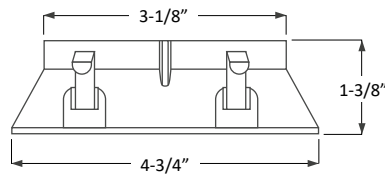

LED HOLDER & FILTER DIMENSION

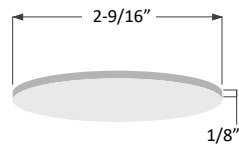

Filter

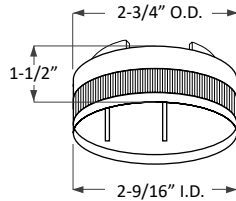

LED Holder

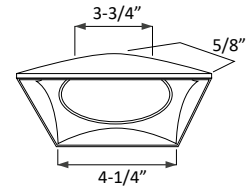
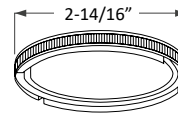

Light Enhancer

HOUSING DIMENSION

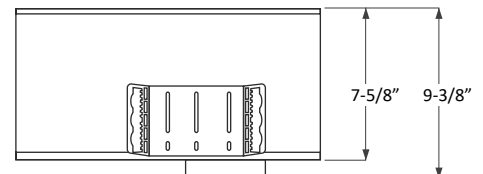
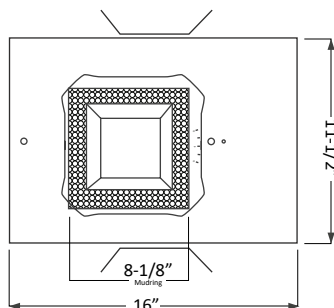
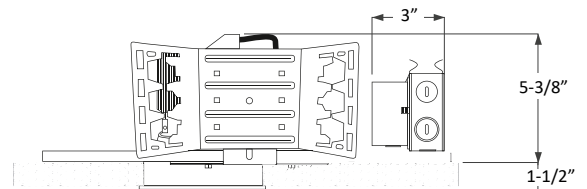
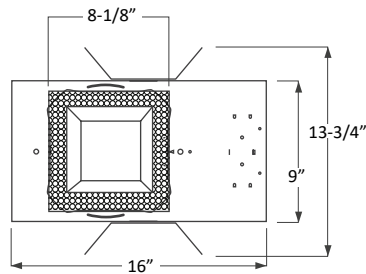

COLLAR DEPTH PER CEILING THICKNESS

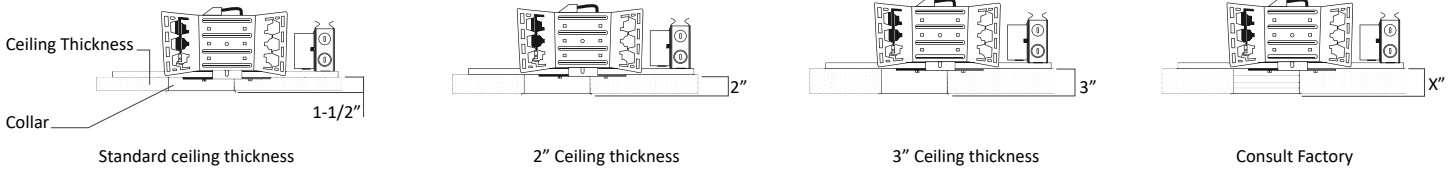

FRAME ACCESSORIES

