



WARM DIM

USE OF PRODUCT

The 6" Prime Downlight Series is the ideal product for architectural energy efficient lighting in commercial and residential applications. Available in die cast trims, with an assortment of optics and dimmable drivers. Color Temperature gradually transitions from 3000K to 1800K simulating natural sunsets.

LED ENGINE

LED engine available with Warm-Dim standard 90+ CRI. 2 Step MacAdam ellipse allows for color consistency between fixtures. LED mounted to aluminum heat sink for maximum life output and thermal management. Light engine provides a quick disconnect with locking strain relief to housing.

FRAME CONSTRUCTION

Constructed from 16 gauge heavy duty powder coated cold rolled steel frame with a large access junction box.

ADJUSTMENT

- Housing provides for 360° locking rotation
- Aperture collar adjusts 15°± horizontally within frame for square ceiling alignment
- Collar notch allows for easy alignment for square applications.
- Aperture collar compatible up to 1½" ceiling thickness.
- Accommodation for 2" or 3" ceiling thickness available upon request.

OPTICS

Field replaceable optical lens available in 18°, 30°, 50°, and 80°. Easily achieve narrow spot to wide flood beam pattern. Option for frosted, honeycomb, or solite filter (2 maximum).

DIMMING

Available in 8 driver selections. (ID) Standard all-inclusive ELV, Triac, and 0-10V dimming driver called Intelligent Drive, 120-277V. (PEQ0) Lutron Hi-Lume Premier Ecosystem 0.1% w/soft on, fade to black dimming, 120-277V. (LDE1) Lutron Hi-Lume 1% Ecosystem with soft on, fade to black dimming, 120-277V. (LTE) Lutron Hi-Lume 1% 2-wire, 120V. (L3DA) Hi-lume 1% Eco-System/3-Wire L3D Driver (EEI) eldoLED Eco 1% Dim (0-10V), 120-277V. (EDIO) eldoLED Solo 0.1% Dim(0-10V), 120-277V. (EDID) eldoLED Solo 0.1% Dim(DALI), 120-277V.

THERMAL MANAGEMENT

Ambient temperatures at fixture location should not exceed -20° to 40°C.

EMERGENCY BATTERY

Optional emergency battery available for a minimum of 90 minutes with both integral or remote test switch in 800 or 1700 delivered lumens.

TRIM OPTIONS

- All Bevels are self flange die cast or anodized.
- Trim includes standard frosted acrylic diffuser.
- 12% lumens increase if remove standard frosted acrylic diffuser in field.
- Optical Enhancer reflects light evenly across the diffusion lens.
- Trims available in round or square in an assortment of standard or made to order finishes.

LABELS/COMPLIANCE/WARRANTY

- CSA Listed for US and Canada
- Dry/Damp/Wet location rated.
- 5 Year limited warranty



ORDERING INFORMATION

RPA

Series	Aperture size	Lumens	Color Temperature	Voltage	Dimming	Optical Lens	Filter
RPA	6 - 6"	9L - 975 lm	WD - Warm Dim	UNV - 120-277	ID ¹	18 - 18°	None - Leave blank
PRIME Series		11L - 1100 lm		120 - 20V	PEQ0	30 - 30°	F - Frosted filter
				347 - 347V	LDE1	50 - 50°	H - Honey comb
					LTE ²	80 - 80°	S - Solite filter
					L3DA		
					EEI ^{3,4}		
					EDIO ^{3,4}		
					EDID ^{3,4}		

Housing Type	Aperture	Frame Accessories	Collar	Options
NC - Non-IC New Construction	RLDP - Round Flangeless Downlight Plaster	C - C-Channel bar hanger	Blank - 1.5" Depth	EI8 - Emergency battery with integral switch(800 Lumens)
IC - Air-tight New Construction	RLDM - Round Flangeless Downlight Milwork	B - Flat bar hanger	20 - 2" Depth	ER8 - Emergency battery with remote switch (800 Lumens)
		WJ - Wood Joist	30 - 3" Depth	EI17 - Emergency battery with integral switch(1700 Lumens)
			MTO - Made to order	ER17 - Emergency battery with remote switch (1700 Lumens)
				FCJS-E - Vive wireless individual controller(Ecosystem)
				FCJS-0 - Vive wireless individual controller(0-10)
				CP10 - Chicago Plenum

TRIM ORDERING INFORMATION

Aperture Size / Shape / Trim Type / Style	Bevel Finish	Options
6RLO - 6" Round Flangeless Open	W - White	WL - Wet Location
	B - Black	
	H - Haze	
	S - Specular clear	
	WE - Wheat	
	MTO - Made to order	

1. Intelligent Drive is the standard driver.
 2. 120V only.
 3. Must specify logarithmic or linear eldoLED driver.
 4. Confirm dimming curve: linear or logarithmic.

LUMEN CHART

Wattage	Delivered Lumens	Voltage	CRI
10W	975 lm	120 - 277V	90+
12W	1100 lm	120 - 277V	90+

TRIM DIMENSION

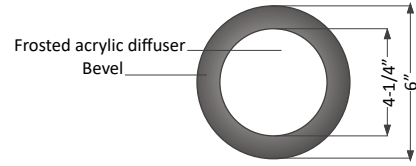
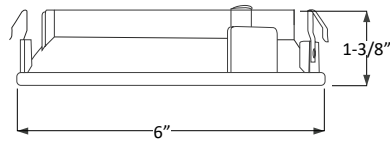

LED HOLDER & FILTER DIMENSION

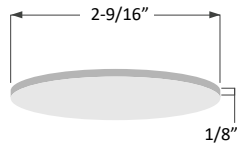

Filter

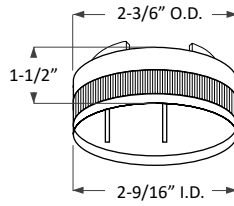

LED Holder

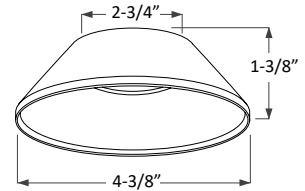
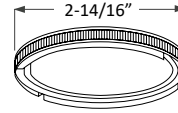

Light Enhancer

HOUSING DIMENSION



NC - Non-IC New Construction

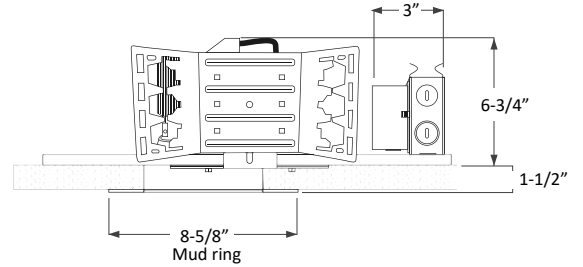
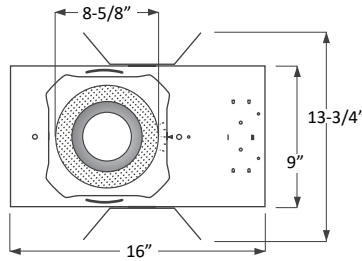

IC - Air-tight New Construction

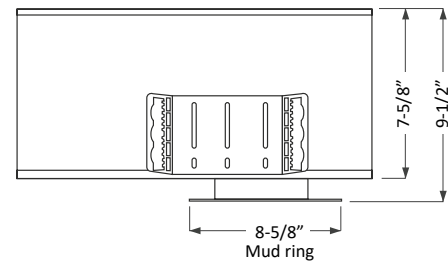
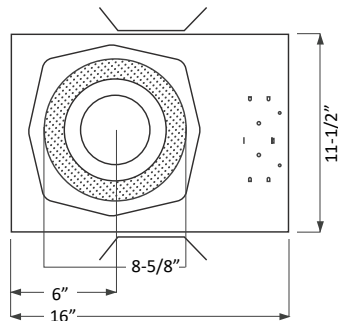

COLLAR DEPTH PER CEILING THICKNESS

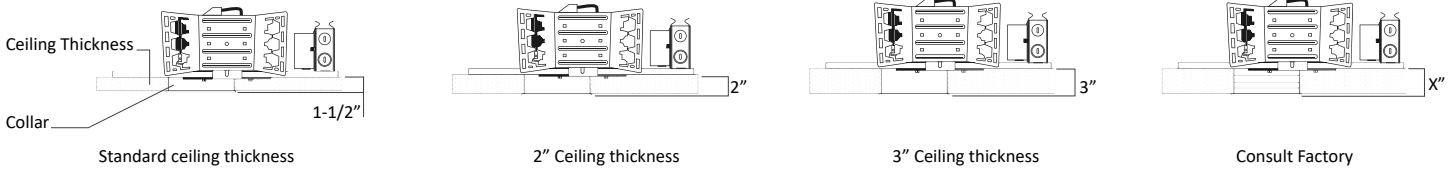

FRAME ACCESSORIES

