

PRIME 6" LED ARCHITECTURAL ROUND FLANGELESS TURTLE FRIENDLY DOWNLIGHT



USE OF PRODUCT

The 6" Prime Turtle friendly Series is suitable for use in ecologically sensitive areas, sea turtle nesting areas, migratory corridors and Dark Sky friendly communities. Light produced by the Amber LED is visible to humans and can be safely used for outdoor lighting applications, but it is virtually undetectable to sea turtles and other forms of marine wildlife.

LED ENGINE

Amber color temperature for optimal spectral power distribution for preservation of endangered sea turtle populations.

FRAME CONSTRUCTION

Constructed from 16 gauge heavy duty powder coated cold rolled steel frame with a large access junction box.

ADJUSTMENT

- Housing provides for 360° locking rotation
- Aperture collar adjusts 15°± horizontally within frame for square ceiling alignment
- Collar notch allows for easy alignment for square applications.
- Aperture collar compatible up to 1½" ceiling thickness.
- Accommodation for 2" or 3" ceiling thickness available upon request.

OPTICS

Field replaceable optical lens available in 30°, 50°. Easily achieve narrow spot to wide flood beam pattern. Option for frosted, honeycomb, or solite filter (2 maximum).

DIMMING

Available in 8 driver selections. (ID) Standard all-inclusive ELV, Triac, and 0-10V dimming driver called Intelligent Drive, 120-277V. (PEQ0) Lutron Hi-Lume Premier Ecosystem 0.1% w/soft on, fade to black dimming, 120-277V. (LDE1) Lutron Hi-Lume 1% Ecosystem with soft on, fade to black dimming, 120-277V. (LTE) Lutron Hi-Lume 1% 2-wire, 120V. (L3DA) Hi-lume 1% EcoSystem/3-Wire L3D Driver (EEI) eldoLED Eco 1% Dim (0-10V), 120-277V. (EDIO) eldoLED Solo 0.1% Dim(0-10V), 120-277V. (EDID) eldoLED Solo 0.1% Dim(DALI), 120-277V.

THERMAL MANAGEMENT

Ambient temperatures at fixture location should not exceed -20° to 40°C.

EMERGENCY BATTERY

Optional emergency battery available for a minimum of 90 minutes with both integral or remote test switch in 800 or 1700 delivered lumens.

TRIM OPTIONS

- All Bevels are self flange die cast or anodized.
- Trim includes standard frosted acrylic diffuser.
- 12% lumens increase if remove standard frosted acrylic diffuser in field.
- Optical Enhancer reflects light evenly across the diffusion lens.
- Trims available in round or square in an assortment of standard or made to order finishes.

LABELS/COMPLIANCE/WARRANTY

- CSA Listed for US and Canada
- Certified FWC
- 5 Year limited warranty



ORDERING INFORMATION

RPA

Series	Aperture size	Lumens	Color Temperature	Voltage	Dimming	Optical Lens	Filter	Housing Type	Aperture	Frame	Collar	Option
RPA	6 - 6"	5L - 500 lm	A - Amber	UNV - 120-277 120 - 20V 347 ¹ - 347V	ID ² Standard all-inclusive ELV, Triac, and 0-10V dimming driver (Intelligent Drive) PEQ0 Lutron Hi-Lume Premier Ecosystem 0.1% w/soft on, fade to black dimming LDE1 Lutron Hi-Lume 1% Ecosystem with soft on, fade to black dimming LTE ³ Lutron Hi-Lume 1% 2-wire L3DA Hi-lume 1% EcoSystem/3-Wire L3D Driver EEI ⁴ eldoLED Eco 1% Dim (0-10V) EDIO ⁴ eldoLED Solo 0.1% Dim (0-10V) EDID ⁴ eldoLED Solo 0.1% Dim (DALI)	30 - 30° 50 - 50°	None - Leave blank F - Frosted filter H - Honey comb S - Solite filter					

Housing Type	Aperture	Frame Accessories	Collar	Options
NC - Non-IC New Construction IC - Air-tight New Construction	RLDP - Round Flangeless Downlight Plaster RLDM - Round Flangeless Downlight Milwork	C - C-Channel bar hanger B - Flat bar hanger WJ - Wood Joist	Blank - 1.5" Depth 2 - 2" Depth 3 - 3" Depth MTO - Made to order	EI8 - Emergency battery with integral switch(800 Lumens) ER8 - Emergency battery with remote switch (800 Lumens) EI17 - Emergency battery with integral switch(1700 Lumens) ER17 - Emergency battery with remote switch (1700 Lumens) FCJS-E - Vive wireless individual controller(Ecosystem) FCJS-0 - Vive wireless individual controller(0-10)

TRIM ORDERING INFORMATION

Aperture Size / Shape / Trim Type / Style	Bevel Finish	Options
6RLO - 6" Round Flangeless Open	W - White B - Black H - Haze S - Specular clear WE - Wheat MTO - Made to order	WL - Wet Location

1. Step down transformer required.
2. Intelligent Drive is the standard driver.
3. 120V only.
4. Must specify logarithmic or linear eldoLED diver.
5. Without standard frosted acrylic diffuser.

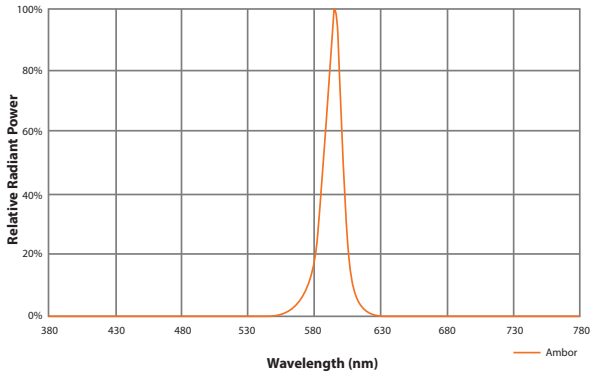

Color	Dominant Wavelength Range				Minimum Luminous Flux (lm) @ 350 mA	
	Minimum		Maximum		Group	Flux (lm)
	Group	DWL (nm)	Group	DWL (nm)		
Amber	A2	585	A3	595	P4	80.6
					P3	73.9
					P2	67.2
					N4	62
					N3	56.8

TRIM DIMENSION

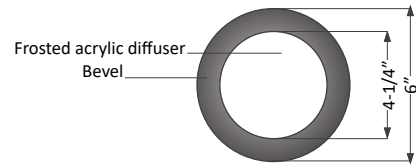
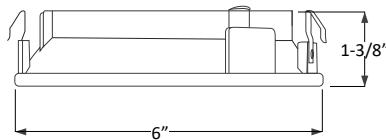

LED HOLDER & FILTER DIMENSION

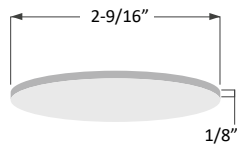

Filter

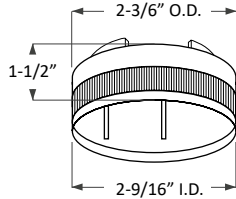

LED Holder

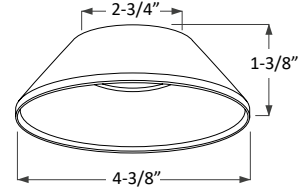
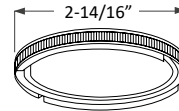

Light Enhancer

HOUSING DIMENSION



NC - Non-IC New Construction

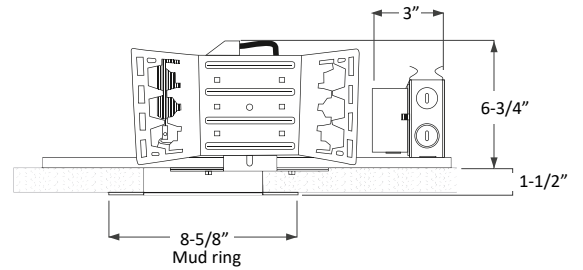
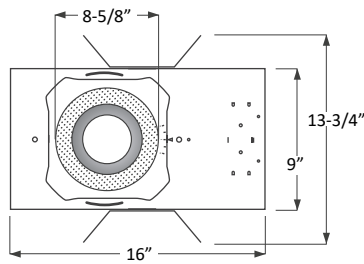

IC - Air-tight New Construction

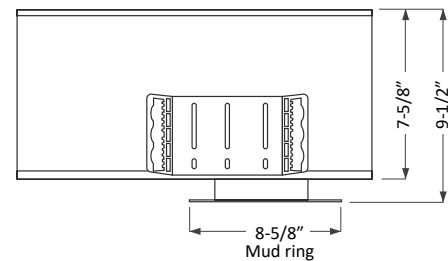
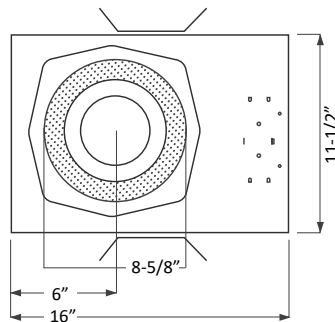

COLLAR DEPTH PER CEILING THICKNESS

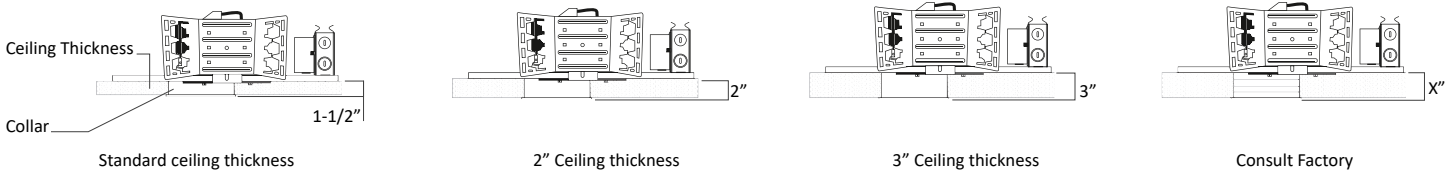

FRAME ACCESSORIES

