



**SilkSpace** combines LED Light Guide technology and Ledalite's revolutionary MesoOptics technology to deliver discrete, comfortable lighting with great performance and ultra low-glare backed by a UGR of less than 19 across all configurations.

**SilkSpace now includes AccuRender technology for the highest color quality at the highest efficacy.**

Project: \_\_\_\_\_  
 Location: \_\_\_\_\_  
 Cat.No: \_\_\_\_\_  
 Type: \_\_\_\_\_  
 Line ID: \_\_\_\_\_ Qty: \_\_\_\_\_  
 Notes: \_\_\_\_\_

### Ordering guide

example: 4224D1STL94068Q1DE

Family	Size	Version	Configuration	Source	CRI/CCT <sup>1</sup>	Lumens <sup>1</sup>
<b>42</b>				<b>L</b>		
42 SilkSpace	22 2'x2'	<b>D1</b> Standard T-Grid <b>C1</b> Standard T-Grid + Chicago Plenum	<b>ST</b> Standalone <b>CR</b> Continuous Row (1'x4' or 2'x4')	L LED	<b>940</b> CRI 90, 4000K <b>935</b> CRI 90, 3500K <b>930</b> CRI 90, 3000K	40 4000lm
	14 1'x4'					30 3000lm
	24 2'x4'					17 1700lm
						68 6800lm
						52 5200lm
						40 4000lm
Optics	Wiring <sup>2,3</sup>	Voltage <sup>2,3</sup>	Driver <sup>2,3</sup>	Option	Systems/Controls <sup>4,5</sup>	
<b>Q</b>						
Q Light Guide with MesoOptics	<b>1</b> Single Circuit <b>B</b> Single Circuit + Battery Pack	<b>D</b> UNV 120-277V <b>3</b> 347V	<b>E</b> Advance Xitanium 0-10V (1% Dim) <b>D</b> Advance Xitanium DALI (5% Dim) <b>H</b> Lutron EcoSystem LDE1 (<1% Dim, Fade-to-Black)	<b>P</b> Flex Whip (6') <b>D</b> Drywall Trim Kit <b>F</b> Drywall Trim Kit + Flex Whip (6')	Leave blank	

1. Nominal values within a range. Consult photometry data for CRI, color temp, lumens & distribution of chosen configuration.  
 2. Not all wiring types are available with all configurations. Consult Ledalite for a complete list of available options.  
 3. 347V not available with Battery Pack. GTD, DALI, Lutron EcoSystem or Sensor Ready drivers or Interact Pro options.  
 4. Interact Pro options require separate controls hardware by Signify.  
 5. Must order IRT9015 Interact commissioning remote with each system order.

**Note:** Due to continuing product improvements, Ledalite reserves the right to change the specifications without notice.

# SilkSpace recessed

2'x2', 1'x4' & 2'x4'

## Dimensions



Size

2'x2' (22)

1'x4' (14)

2'x4' (24)

Cross section view

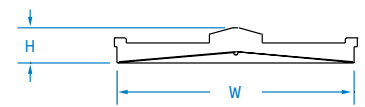
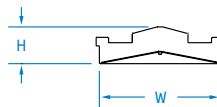
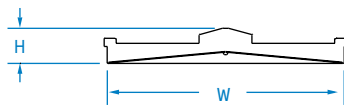

Back view

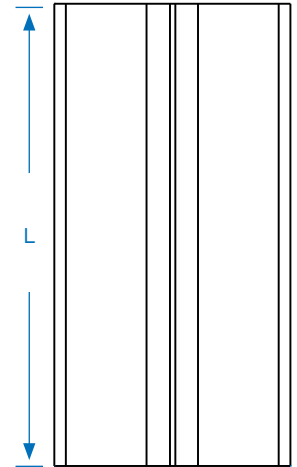
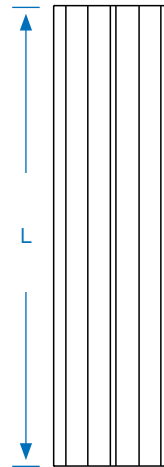
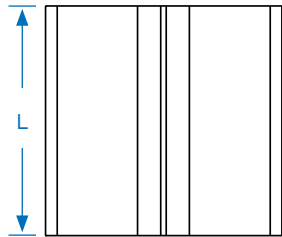

Size	W	L	H
2'x2' (22)	23 3/4" [602mm]	23 1/2" [598mm]	3 1/2" [90mm]
1'x4' (14)	11 5/8" [296mm]	47 1/2" [1208mm]	3 1/2" [90mm]
2'x4' (24)	23 3/4" [602mm]	47 1/2" [1208mm]	3 1/2" [90mm]

# SilkSpace recessed

2'x2', 1'x4' & 2'x4'

## Mounting details

### Flat T-Grid

Integrates with most common T-Grid types. Works with 9/16" & 15/16" flat T-Grid ceilings

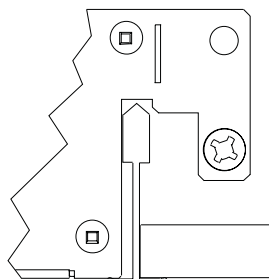

### Slot T-Grid

Can be used with slot T-Grid ceilings. For 9/16" slot T-Grid ceilings, fixture will sit 5/16" above bottom of T-Bar.

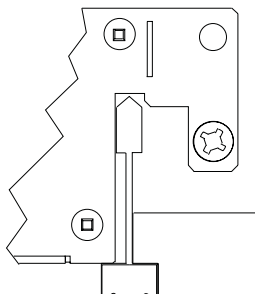

### Drywall Trim Kit

The drywall trim kit mounting frame assembly is designed to permit use of grid (NEMA G) fixtures in drywall or ceilings requiring flanges. Finish is white.

Extruded aluminum construction with mitered corners. Includes screws for complete assembly. Available in 2'x2', 2'x4' & 1'x4' sizes.

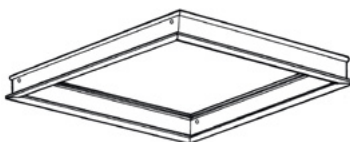

Drywall Kit Ordering Code	Size
300DK02	1'x4'
300DK03	2'x2'
300DK04	2'x4'

More information available at:

[http://docs.ledalite.com/download/pdf/ID-Recessed\\_Drywall\\_Kits.pdf](http://docs.ledalite.com/download/pdf/ID-Recessed_Drywall_Kits.pdf)

### Wood Frame Hanger Wire

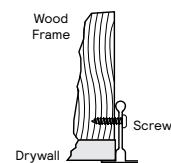

Wood frame and screws supplied by others.

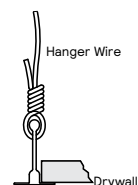

Hanger wires supplied by others.

# SilkSpace recessed

## 2'x2', 1'x4' & 2'x4'

### Specifications

#### Optical System

The optical system is comprised of arrays of LEDs edge lighting a low profile light guide panel. The micro structured surface of the light guide panel optimizes the light extraction creating a homogeneously luminous appearance. Light is then controlled by MesoOptics film suppressing the high-angle light creating an ultra low-glare bat-wing distribution.

#### Finish

Housing and Frame painted, high quality, powder coated matte white only.

#### Housing

Sides and center spine: precision aluminum extrusion; end caps, back housing and driver cover: die-formed, 20 gauge cold-rolled steel, pre and post painted. Available in white. Multiple wire entrances are available (top or side) to allow continuous row mounting of fixtures.

#### Weight

Maximum 28lbs (2x4); 21lbs (1x4); 15lbs (2x2).

#### Electrical

Factory pre-wired.

#### Mounting

Fixtures are factory pre-wired and tested for all circuits and emergency battery packs. Compatible with 15/16" lay-in acoustical ceilings using exposed grid suspension (NEMA type G). For 9/16" slot T-grid ceilings, fixture will sit 5/16" above bottom of Tee. Optional drywall kit trim mount can be fastened to a wood frame or with hangar wire. Continuous row mounting not available with drywall kit trim mounts.

#### Standard Driver

Advance Xitanium 0-10V, 1% dimming.

Advance Xitanium Sensor Ready (SR), 1% dimming.

Advance Xitanium DALI, 5% dimming.

Lutron EcoSystem LDE1, 1% dimming with Soft-on, Fade-to-Black.

Class 2 rated output.

Consult Ledalite for other available drivers.

#### Standard Battery Packs

Bodine Battery Pack, 90 min, 10W, Class 2 rated output.

Lumen output = 10W x luminaire efficacy x 1.1. Typical output 1100lm.

#### Lumen Maintenance

LEDs have been tested by the manufacturer in accordance with IESNA LM-80-08. At an ambient temperature of 25°C, the LED lumen maintenance expectation according to IES TM-21-11:

$L_{90}$  (10k) >60,000 hrs (Reported methodology)

#### Source Color

LEDs rated for color rendering of:

CRI >90 & R9>50

Fixture to fixture color accuracy within:

2 SDCM for Static White luminaires

#### Wiring

Optional flex whips are supplied in 6' lengths.

#### Approvals

Certified to UL, CSA, and IES standards. City of Chicago Approved CCEA (version option C1).

#### Quick Ship

Available for most non-connected configurations upon request. More information available at: [www.signify.com/en-us/brands/ledalite/quickship](http://www.signify.com/en-us/brands/ledalite/quickship)

#### Warranty

Five-year luminaire limited warranty including LED boards and driver.

[www.signify.com/warranties](http://www.signify.com/warranties)

#### Environment

Rated for dry & damp locations in operating ambient temperatures of 0-25°C (32-77°F). Many luminaire components, such as reflectors, refractors, lenses, and LEDs are made from various types of plastics which can be adversely affected by airborne contaminants. If sulfur based chemicals, petroleum based products, cleaning solutions, or other contaminants are expected in the intended area of use, consult factory for compatibility. Damage caused by sulfur, chlorine, petroleum based solution or other contaminants are not covered under warranty.

#### WELL v2 Building Standard

SilkSpace luminaires with MesoOptics contribute towards satisfying the following features under the WELL v2 Building Standard:

**L03:** When specified with the Tunable White system.

**L04:** Glare management with all configurations at <19 UGR.

**L06:** Brightness management with batwing distributions allowing for even lighting within a space, while spacing the fixtures wider apart than a typical recessed luminaire product.

**L07:** AccuRender CRI 90 standard LED boards with high performance Advance drivers (or optional drivers) to manage color quality and flicker

**L08:** When specified with Interact or when tied to a 3rd party control system.

# SilkSpace recessed

## 2'x2', 1'x4' & 2'x4'

### Wireless Controls Options

#### Interact Pro scalable sensor for Foundation, Advanced & Enterprise tiers (CS an evolution of SpaceWise):

- CS is a connected sensor with integral occupancy and daylight sensing and supports wireless mesh connectivity.
- The sensor works in the Foundation mode (similar to SpaceWise) when configured without a gateway or in an Interact Pro Advanced or Enterprise mode if a compatible gateway is used.
- Interact Pro includes an App, a portal and a broad portfolio of wireless luminaires, lamps and retrofit kits all working on the same system.
- Startup is implemented via Interact Pro App (Android or iPhone) & Bluetooth connectivity. The App provides flexibility to choose between a gateway or non gateway mode for setup.
- Setup with the gateway requires wired internet access to the gateway. It is possible to add a gateway at a later point.
- Prepare project configuration steps remotely and use IRT9015 remote onsite to identify and group devices together.
- Compatible with UID8451/10 wireless dimmer switch, SWS200 wireless scene switch, wireless Occ sensor (OCC SENSOR IA CM IP42 WH 10/1) and wireless Day/Occ sensor (OCC MULTI SENSOR IA CM WH 10/1).
- For more information on Interact Pro visit: [www.interact-lighting.com/interactproscalablesystem](http://www.interact-lighting.com/interactproscalablesystem)

#### Emergency Options (R):

- Power Sensing (Factory default) – Recommended
- UL924 option requires unswitched power sense line, absence of voltage on the normal circuit triggers luminaire to 100% output.
- Power Interruption Detection (Field option)
- Detects AC power interruption >30ms triggers 90 minute emergency mode with luminaire at 100% output.

#### Interact Pro scalable sensor bundles for Enterprise tier (SB):

- SB option, in addition to occupancy and daylight sensing, supports advanced IoT capabilities such as people estimation analysis, desk level temperature & humidity sensing, noise classification, and BLE beacon.
- Compatible with UID8451/10 wireless dimmer switch, SWS200 wireless scene switch, wireless Occ sensor (OCC SENSOR IA CM IP42 WH 10/1) and wireless Day/Occ sensor (OCC MULTI SENSOR IA CM WH 10/1).
- Use Interact software and insights to increase building efficiency, achieve building wide integration and optimize space through occupancy analytics.
- Requires compatible Gateway and internet connectivity for commissioning. For more information, visit: [www.interact-lighting.com/office](http://www.interact-lighting.com/office)

### Wired Controls Options

#### Interact Office Wired PoE (IO & SB):

- PoE based IoT connected lighting solution for large enterprises that span across multiple floors, buildings and require multiple gateways.
- Use Interact software and insights to increase building efficiency, achieve building wide integration and optimize space through occupancy analytics.
- Integral sensor option for occupancy sensing (PIR) and/or daylight harvesting available for additional energy savings.
- SB option, in addition to occupancy and daylight sensing, supports advanced IoT capabilities such as people estimation analysis, desk level temperature & humidity sensing, noise classification, and BLE beacon.
- Optional integral emergency controller and battery pack provides backup lighting in the case of a power outage. Test switch and indicator light mounted on the chassis.
- Emergency battery has a 3 month pre-installed shelf life, and must be stored and installed in environments of -20°C to 30°C (-4F to 86F) ambient, and 45-85% relative humidity.
- For more information on Interact Office Wired visit: [www.interact-lighting.com/office](http://www.interact-lighting.com/office)

Note: Signify Interact Office Luminaires are not sold individually and are only compatible with Signify's Interact Office control system & software. The system requires a compatible back-end IT infrastructure for normal operations, please consult your Signify representative for additional information.

#### Tunable White:

- Tunable White is available in Interact Office Wired PoE luminaires. Other control options for Tunable White with DALI (DT6 or DT8), 0-10V, Lutron T Series or DMX control are available via an Engineered-to-Order (ETO) request.
- Signify tunable white solutions are designed to help maximize the influence of lighting on your daily life.
- Dynamic behaviors via scheduled lighting recipes mimicking daylight patterns or supporting biorhythms.
- Scene setting via lighting pre-sets based on various combinations of lighting color temperature and intensity.

Interact Pro scalable sensor option codes across Genlyte product lines

	Evokit	Day-Brite	Ledalite	Lightolier
Zigbee + Bluetooth + Sensing	SWZCS	SWZCS	CS	SBA accessory (external)
Zigbee + Bluetooth	RADIO	RADIO	RA	RA
Zigbee + Bluetooth + Sensing + Environmental data	IAOSB	IAOSB	SB	SB
Zigbee + Highway + Sensing	-	SWZCSH	-	-

# SilkSpace recessed

2'x2', 1'x4' & 2'x4'

## Functionalities overview

Interact Pro scalable system			
	Foundation	Advanced	Enterprise
Dimming, grouping, and zoning	✓	✓	✓
Bluetooth and ZigBee enabled	✓	✓	✓
Motion sensing and daylight harvesting	✓	✓	✓
Integration with 0-10V and phase dimming fixtures	✓	✓	✓
Code compliance	✓	✓	✓
Granular dimming and dwell time	✓	✓	✓
<b>New</b> Correlated color temperature (CCT) tuning by switch	✓	✓	✓
<b>New</b> Support for sensor-based Tunable White luminaires	✓	✓	✓
Energy reporting and monitoring		✓	✓
Scheduling		✓	✓
Demand response		✓	✓
BMS integration (BACnet)			✓
Floor plan visualization			✓
IoT sensors for wellness			✓
IoT Apps for productivity			✓

## Currently supported maximum system size

To be able to design the lighting system correctly for the customer, it is important to know the prime characteristics of the system, its possibilities and limitations.

System level	
Total number of gateways	Unlimited
Total number of devices	200 per network
• luminaires with integrated sensors	150
• smart TLEDS	150
Total number of ZGP devices (sensors and switches)	50
• sensors	30
• switches	50
• zones and groups	64
Group level	
Recommended number of lights	40 (recommended 25)
Number of ZGP devices	5
Number of scenes	16

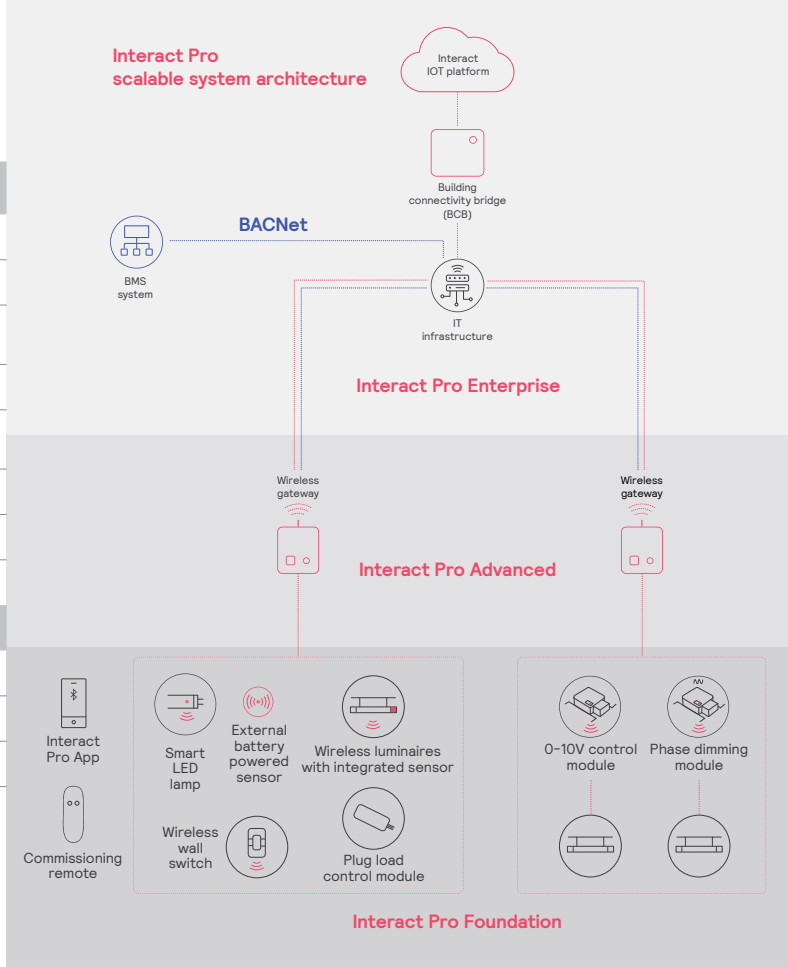

# SilkSpace recessed

## 2'x2', 1'x4' & 2'x4'

### Colorimetry

#### SilkSpace Performace with MesoOptics (42)

Nominal CRI & CCT		CRI 90, 3000K	CRI 90, 3500K	CRI 90, 4000K
CIE 013.3-1995 <sup>1</sup>	CRI R <sub>a</sub>	93	92	92
	R <sub>s</sub>	53	49	54
	G <sub>a</sub>	97	96	96
	C <sub>9</sub>	92	91	92
IES TM-30-18 <sup>2</sup>	R <sub>f</sub>	92	91	90
	R <sub>f,h1</sub>	90	88	89
	R <sub>g</sub>	98	98	97
	R <sub>mc,h1</sub>	-6%	-6%	-6%
MDER <sup>3</sup>		0.47	0.54	0.61

- Color Rendering Index (CRI Ra) and Strong Red (R9) are calculated in accordance with CIE 013.3-1995. Color Gamut index (Ga) and red chroma Index (C9) are CIE based properties using the Global Lighting Association's calculation tool.
- Fidelity Index (Rf), Red Fidelity Index (Rf,h1), Gamut Index (Rg), and Red Local Chroma Shift (Rcs,h1) are calculated in accordance with IES TM-30-18.-18.
- Melanopic Daylight Efficacy Ratio (MDER) is the measure for "spectral melanopic efficiency" as defined in CIE S 026-2018.

### Photometry

#### SilkSpace Performace with MesoOptics (42)

Click "PDF" or "IES" text to download

Nominal CRI & CCT		CRI 90, 3000K					CRI 90, 3500K					CRI 90, 4000K				
Size & Nominal Lumen Package	Watts (W)	Flux (lm) <sup>1</sup>	Efficacy (LPW) <sup>1</sup>	UGR <sup>2</sup>	Photometry Report	IES File	Flux (lm) <sup>1</sup>	Efficacy (LPW) <sup>1</sup>	UGR <sup>2</sup>	Photometry Report	IES File	Flux (lm) <sup>1</sup>	Efficacy (LPW) <sup>1</sup>	UGR <sup>2</sup>	Photometry Report	IES File
2'x2' - 4000lm	36.9	3825	104	18	PDF	IES	3990	108	18	PDF	IES	4006	109	18	PDF	IES
2'x2' - 3000lm	27.3	2871	105	17	PDF	IES	2991	110	17	PDF	IES	3004	110	17	PDF	IES
2'x2' - 1700lm	15.5	1628	105	15	PDF	IES	1698	110	15	PDF	IES	1699	110	15	PDF	IES
1'x4' - 4000lm	35.0	3832	110	18	PDF	IES	3995	114	18	PDF	IES	4002	114	18	PDF	IES
1'x4' - 3000lm	26.6	2884	108	17	PDF	IES	3007	113	17	PDF	IES	3008	113	17	PDF	IES
1'x4' - 1700lm	15.6	1630	105	15	PDF	IES	1700	109	15	PDF	IES	1699	109	15	PDF	IES
2'x4' - 6800lm	57.1	6516	114	17	PDF	IES	6794	119	18	PDF	IES	6822	120	18	PDF	IES
2'x4' - 5200lm	43.1	4979	116	16	PDF	IES	5191	120	17	PDF	IES	5206	121	17	PDF	IES
2'x4' - 4000lm	33.3	3828	115	16	PDF	IES	3991	120	16	PDF	IES	3996	120	16	PDF	IES

- Luminaire photometry has been conducted in accordance with IES LM-79-08. IES files can be downloaded by clicking the links in the table above, or online at [ledalite.com](http://ledalite.com). Luminaires with finishes other than standard white may result in a drop in flux and efficacy.
- Unified Glare Rating (UGR) is calculated in accordance with CIE 117-1995. Reference conditions of 4Hx8Hx1H and reflectances of 70/50/20% have been applied using the procedure described in CIE 190-2010.

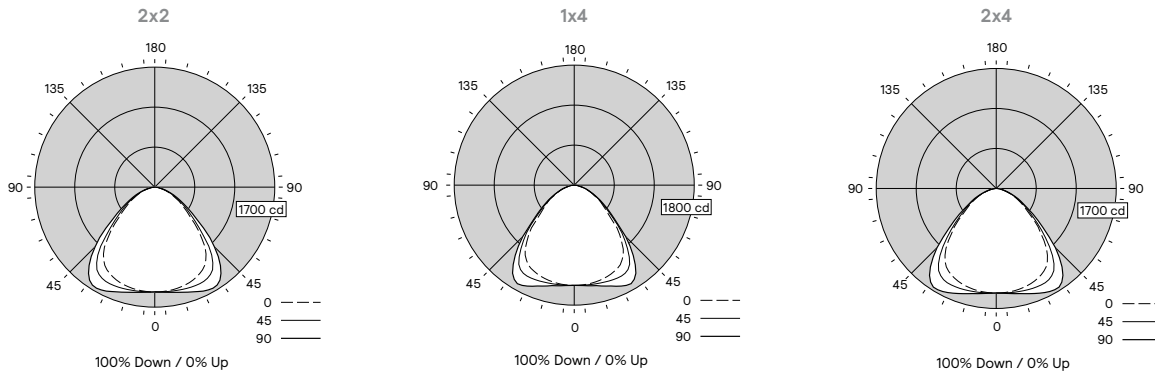

Photometric data shown is for 4000lm, CRI 90, 3500K configurations.



© 2023 Signify Holding. All rights reserved. The information provided herein is subject to change, without notice. Signify does not give any representation or warranty as to the accuracy or completeness of the information included herein and shall not be liable for any action in reliance thereon. The information presented in this document is not intended as any commercial offer and does not form part of any quotation or contract, unless otherwise agreed by Signify.

Signify North America Corporation  
400 Crossing Blvd, Suite 600  
Bridgewater, NJ 08807  
Telephone: 800-555-0050

Signify Canada Ltd.  
281 Hillmount Road,  
Markham, ON, Canada L6C 2S3  
Telephone: 800-668-9008

All trademarks are owned by Signify Holding or their respective owners.