

**DIMENSIONAL DATA** (see page 4 for additional details)

**Simple Slope 2**

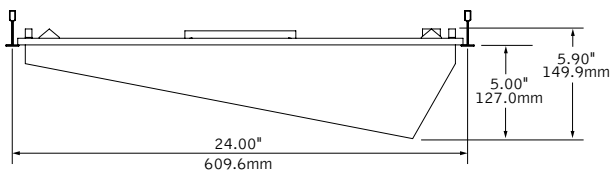

All Ori tiles have a drop of 5.00" at their deepest point

**Simple Slope 2**

Plenum/Chicago Plenum

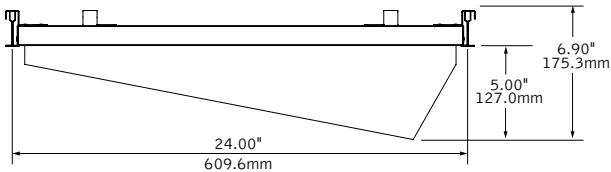

**Profiles**

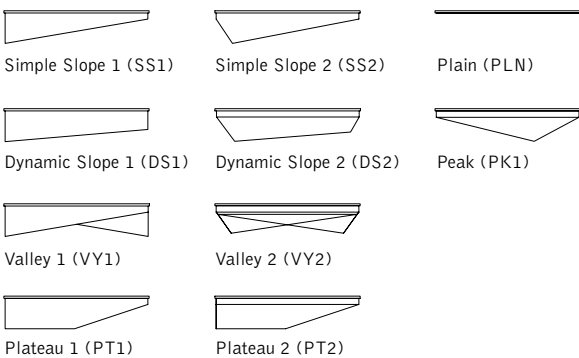

**FEATURES**

2x2 sound absorbing tiles available in ten design variations to add dimension to the ceiling plane.

Cut and folded, not thermoformed, to yield crisp, defined edges.

Noise Reduction Coefficient (NRC) average of 1.1, varies for each design. Refer to ASTM C423 test reports for more information.

Wide range of color options provides design flexibility and personalization for any project.

Plenum option meets construction requirements for CCEA (Chicago Plenum) marking, 2015 IMC 602.2 & 2018 NFPA 90A.

**ACOUSTIC PERFORMANCE\***

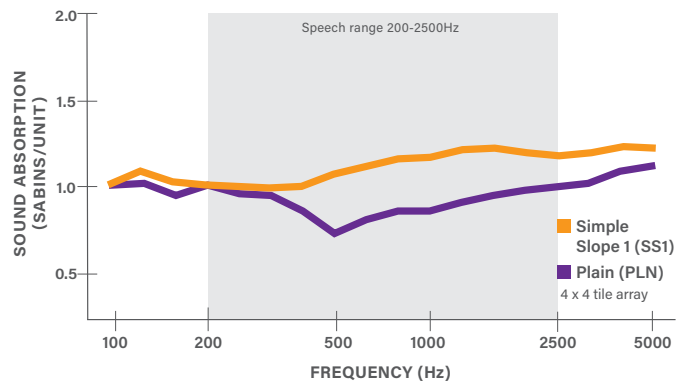

\*Standard tile only. Plenum results will vary.



# Acoustic Material Colors



## STANDARD COLORS

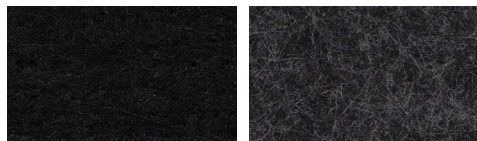

PURE BLACK **PBK** CHARCOAL GRAY **CHG**

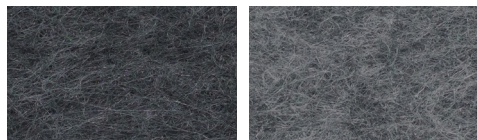

SLATE **SLT** SHADOW GRAY **SDG**

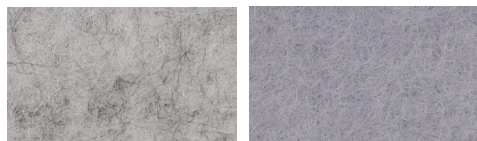

SILVER GRAY **SLG** PEARL ICE **PIC**

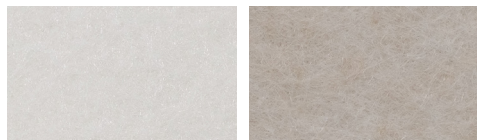

CLASSIC WHITE **CWH** NATURAL LINEN **NTL**



HAZELWOOD **HZW**

## PREMIUM COLORS\*

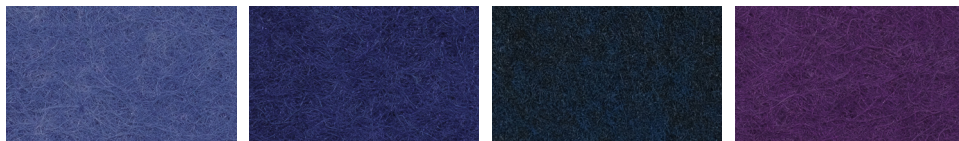

CORNFLOWER BLUE **CFB** DENIM BLUE **DNB** MIDNIGHT BLUE **MNB** DEEP PURPLE **DPP**

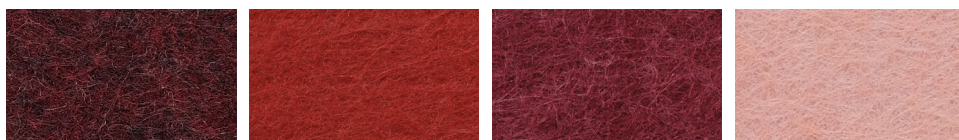

BRICK RED **BRD** CHERRY RED **CHR** BERRY **BRY** BLUSH **BLS**

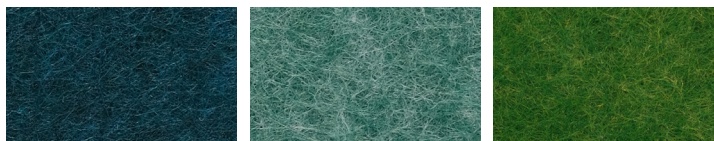

DEEP WATER **DWT** SEAFOAM **SFM** EMERALD GREEN **EMG**

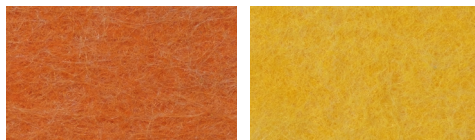

CARROT **CRT** PINEAPPLE **PNA**

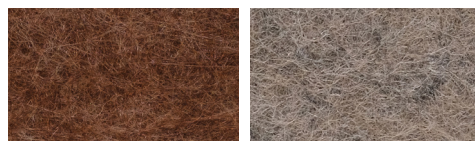

CINNAMON **CNM** LIMESTONE **LMS**

\*Contact factory for lead time and pricing.

## Declare.

### 9mm PET Felt Focal Point, LLC

Final Assembly: Chicago, Illinois, USA  
Life Expectancy: 30 Year(s)  
End of Life Options: Salvageable/Reusable in its Entirety, Recyclable (100%)

#### Ingredients:

Polyethylene terephthalate: PET; N, N'-Ethylene bisstearamide: Octadecanamide, N,N'-1,2-ethanediybis-; Stearic Acid; Antioxidant 1076; Benzene propanoic acid, 3,5-bis(1-(dimethylethyl)-4-hydroxy-octadecyl ester); Antioxidant KY-405; Benzenamine, 4-(1-methyl-1-phenylethyl)-; N-[4-(1-methyl-1-phenylethyl)phenyl]; Titanium Dioxide: Titanium dioxide

Living Building Challenge Criteria: Compliant

#### I-13 Red List:

■ LBC Red List Free      % Disclosed: 100% at 100ppm  
□ LBC Red List Approved    VOC Content: Not Applicable  
□ Declared

I-10 Interior Performance: CDPH Standard Method v1.1-2010

I-14 Responsible Sourcing: Not Applicable

FPL-0001  
EXP. 01 MAR 2024  
Original Issue Date: 2020

MANUFACTURER RESPONSIBLE FOR LABEL ACCURACY  
INTERNATIONAL LIVING FUTURE INSTITUTE™ [living-future.org/declare](http://living-future.org/declare)

## LIGHT REFLECTIVITY

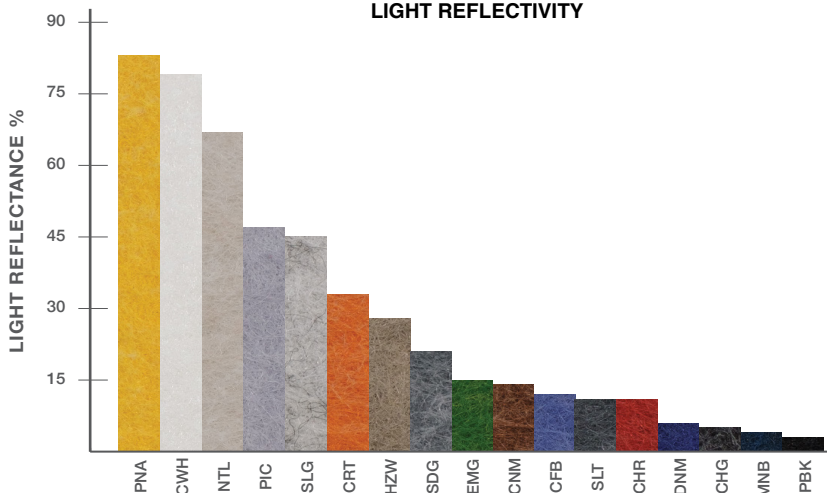

**PROFILE DETAILS**

Simple Slope 1  
(SS1)

Simple Slope 2  
(SS2)

Dynamic Slope 1  
(DS1)

Dynamic Slope 2  
(DS2)

Valley 1  
(VY1)

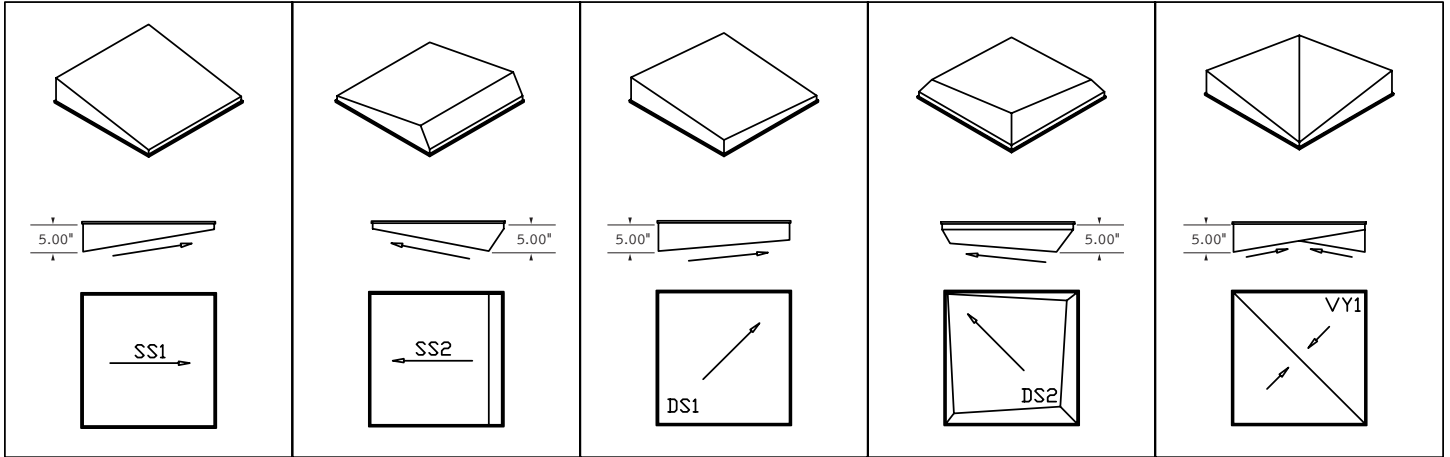

Valley 2  
(VY2)

Plateau 1  
(PT1)

Plateau 2  
(PT2)

Peak  
(PK1)

Plain  
(PLN)

