

ARCHITECTURAL HIGH PERFORMANCE FULL CUTOFF WALL PACK

KEY FEATURES

- Ideal for Exterior Walls, Entryways, Pathways, New Construction and Renovation, Warehouse and Receiving Docks, Court Yards, and School Playgrounds
- Sleek Minimalistic Design of the NV-W2 (up to 24,000 Lumens, 18"W x 9.38"D x 5"H) Compliments the NV-W (up to 11,000 Lumens, 12"W x 9"D x 5.5"H)
- 2700K, 3000K, 3500K, 4000K, 5000K CCT Multichip High Power 70 & 80 CRI LEDs
- IP66 Rated Against Dust & Water Ingress, IK10 Rated for Tamper/Vandalism/Impact Protection
- 20KA Surge Protection (120V - 480V) Cold Weather Integrated Battery Back-Up Safety Options
- Silicone Optics providing 96% Clarity and Heat Resistant up to 150°C
- 8 Standard Finishes, Custom Finish and Marine Grade Finish Available
- Controls Agnostic, Compatible with Most Control Systems and Sensors
- Environmentally Friendly Product Which Reduces Energy Consumption, L70 > 100,000 hours
- IDA qualified for 3000K CCT and Lower for Down-light Application, Reducing Light Pollution and Trespass
- Buy America(n) Option Available, Quick Mount for Easy Installation
- Cost Competitive and Short Shipping Lead Times in Days & Weeks

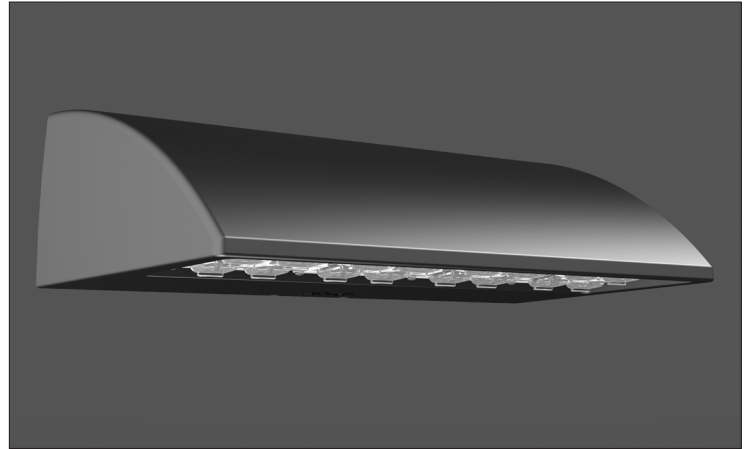

LISTINGS

- Certified to UL 1598
- UL 8750
- CSA C22.2 No. 250.0
- DesignLights Consortium® (DLC) Pending
- DesignLights Consortium Premium® (DLCP) Pending
- IP66 Rated Fixture / IP67 Rated Optics
- IK10 Rated
- IDA Dark Sky Approved



LED WATTAGE CHART

	64L
530 milliamps	99w
700 milliamps	136w
1050 milliamps	205w

Project Name: _____ Type: _____

--	--	--	--	--	--	--	--	--

Cat#	Light Dist.	# of LEDs	Milliamps	Kelvin	Volts	Mounting	Color	Options
NV-W2 (NV-W2)	Type 2 (T2)	64 (64L)	530 (53)	2700K, 70 CRI (27K7) ¹	120-277 (UNV)	Wall Mount (WM)	Bronze Textured (BRZ)	FSP-211 with Motion Sensor (FSP-8) ² *8' Heights and below (FSP-20) ² *9'-20' Heights (FSP-40) ² *21'-40' Heights
	Type 3 (T3)		700 (7)	2700K, 80 CRI (27K8) ^{1 4}	347-480 (HV)		White Textured (WHT)	Button Photocell (PC) ²
	Type 4 (T4)		1050 (1)	3000K, 70 CRI (30K7) ⁴		Smooth White Gloss (SWT)	Nema 7-Pin Receptacle (PE7)	
				3000K, 80 CRI (30K8) ^{1 4}		Silver (SVR)	Emergency Battery 4w (EM4) ^{2 3} Emergency Battery 8w (EM8) ^{2 3}	
				3500K, 80 CRI (35K8)		Black Textured (BLK)	Emergency Cold Pk Battery 14w (EMCP) ^{2 3}	
			4000K, 70 CRI (40K7) ¹		Smooth Black Gloss (SBK)	Marine Grade Finish (MGF)		
			4000K, 80 CRI (40K8)		Graphite Textured (GPH)	Aluminum Vanity Plate 22" x 16" (VP22)		
			5000K, 70 CRI (50K7) ¹		Grey Textured (GRY)	Surge Protector (20KA)		
			5000K, 80 CRI (50K8)		Custom (CS)	Up Light (UP)		
							Black Hardware (BH) ⁵ Black Optic Frame (BOF) ⁵ Conduit Box (JBOX)	

Notes:
¹ Consult Factory for Lead Time. Consult Factory for 90 CRI Requests.
² Universal Voltage 120-277
³ All Emergency Battery Options Certified CA Title 20
⁴ 3000K or lower, with fixed mounting options only, must be selected to meet International Dark-Sky Association certification.
⁵ Consult Factory for Lead Time

PRODUCT SPECIFICATIONS

ELECTRICAL

- 120-277 Volts (UNV) or 347-480 Volts (HV)
- 0-10V dimming driver
- Driver power factor at maximum load is $\geq .95$, THD maximum load is 15%
- LED Drivers Ambient Temp. Min is -40°C and Ambient Temp. Max ranges from 50°C to 55°C and, in some cases, even higher. Consult the factory for revalidation by providing the fixture catalog string before quoting and specifying it.
- All internal wiring UL certified for 600 VAC and 105°C
- All drivers, controls, and sensors housed in enclosed IP66 compartment
- CRI 70, 80, 90
- Color temperatures: 2700K, 3000K, 3500K, 4000K, 5000K

CONSTRUCTION

- Die Cast Aluminum
- Internal cooling fins
- Corrosion resistant external hardware
- One-piece silicone gasket ensures IP66 seal for electronics compartment
- Two-piece silicone Micro Optic system ensures IP67 level seal around each PCB
- Silicone Micro Optics: Recessed, full cutoff, vandal resistant and non-yellowing
- Dark Sky Approved

OPTIONS

MARINE GRADE FINISH (MGF) - A multi-step process creating protective finishing coat against harsh environments. Chemically washed in a 5 stage cleaning system. Prebaked, Powder coated 3-5 mils of Zinc Rich Super Durable Polyester Primer. Oven Baked. Finished Powder Coating of Super Durable Polyester Powder Coat 3-5 mil thickness.

VANITY PLATE (VP) - Optional Vanity Plate was designed to cover the unsightly remains on a wall where a larger HID wallpack was removed. The aluminum Vanity Plate will be painted to match the finish of the NV-W2, custom finishes are available, please consult factory. The standard Vanity Plate is 22"W x 16"H.

20KA SURGE PROTECTOR (20KA) - protects the complete system against nominal surges of up to 20KA. Protection against power surges, storms and lightning strikes.

EMERGENCY BATTERY BACKUP (EM4) (EM8)

EMERGENCY COLD PACK BATTERY (EMPC) - Emergency cold pack battery system available in 14w output.

UP LIGHT (UP) - Inverted luminaire for up lighting.

BLACK HARDWARE (BH) - Black stainless steel hardware.

BLACK OPTIC FRAME (BOF) - Black optic frame. Standard is white.

CONDUIT BOX (JBOX) - Conduit J-Box.

CONTROL OPTIONS

- FSP-211 (FSP-X) - Passive infrared (PIR) sensor providing multi-level control based on motion/daylight contribution.
- All control parameters adjustable via wireless configuration remote storing and transmitting sensor profiles.
- FSP-8 Mounting heights 8 feet and below
- FSP-20 mounting heights 9-20 feet
- FSP-40 mounting heights 21-40 feet.
- Includes 5 dimming event cycles, 0-10V dimming with motion sensing, re-programmable in the field. Programmable remote must be purchased separately.
- FSIR-100 commissioning remote is required to change sensor settings. Please contact factory for ordering.
- Controls Agnostics: Please contact factory for your preferred controls option.

NEMA 7-PIN RECEPTACLE (PE7) - An ANSI C136.41-2013 receptacle provides electrical and mechanical interconnection between photo control cell and luminaire. Dimming receptacle available two or four dimming contacts supports 0-10 VDC dimming methods or Digital Addressable Lighting Interface (DALI), providing reliable power interconnect.

BUTTON PHOTOCELL - Dusk to dawn optional Button Photocell.

FINISH

3-5 mils electrostatic powder coat. NLS Lighting's standard high-quality finishes prevent corrosion, and protects against extreme environmental conditions.

WARRANTY

Five-year limited warranty for drivers and LEDs.

OPTICS

Silicone optics high thermal stability and light output provide higher powered LEDs with minimized lumen depreciation. UV stability with scratch resistance increases exterior application durability. Silicone optics do not yellow, crack or brittle over time.

The information and specifications on this document are subject to change without any notification. All values are design, nominal, typical or prorated values when measured under internal and external laboratory conditions.



701 Kingshill Place, Carson, CA 90746
Call Us Today (310) 341-2037

nlsighting.com

MOTION SENSOR PLACEMENT

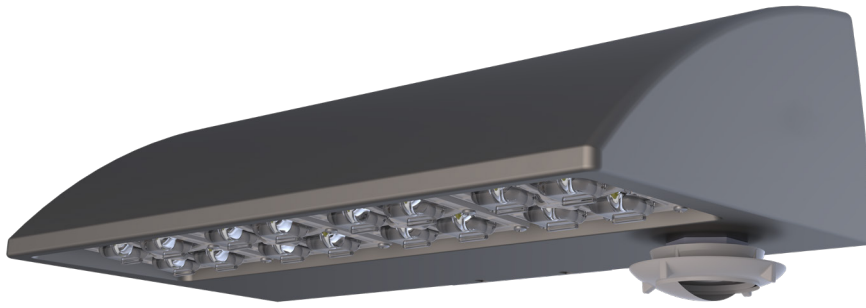

FSP-8

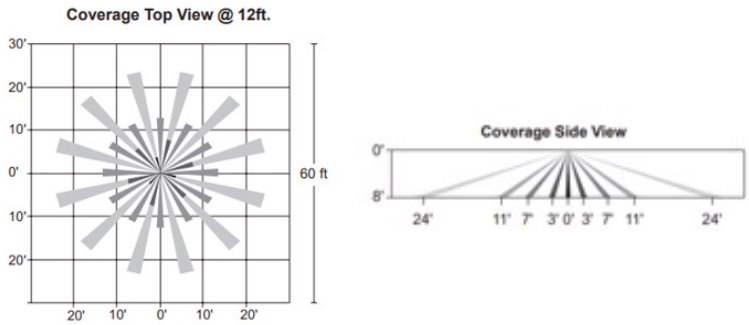

FSP-20

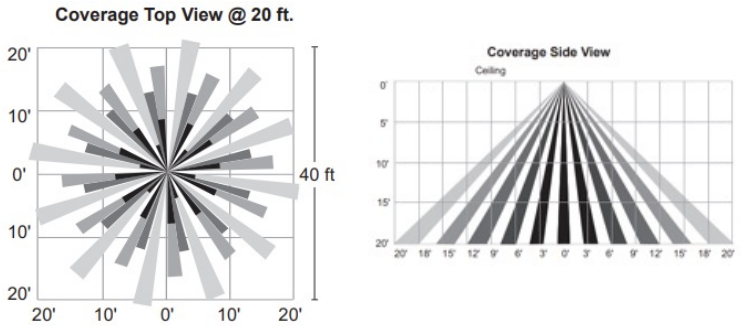

FSP-40

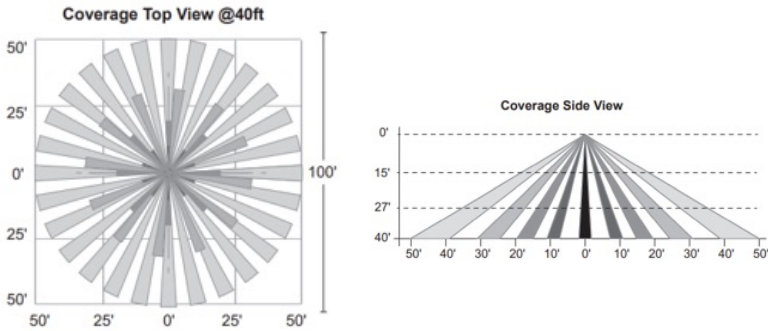

PRODUCT DIMENSIONS

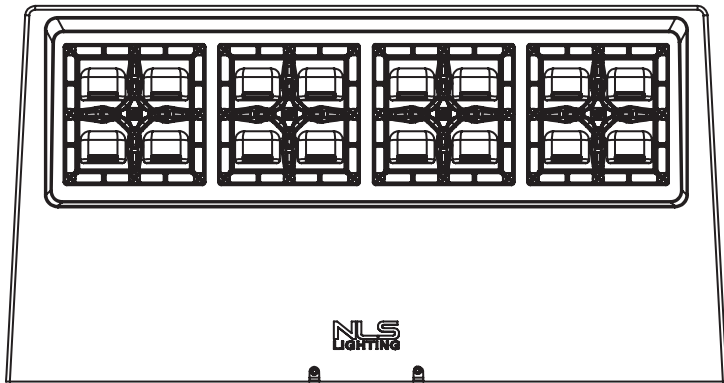
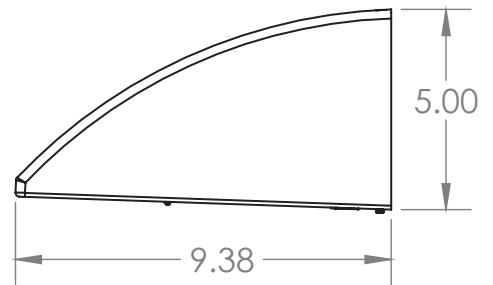
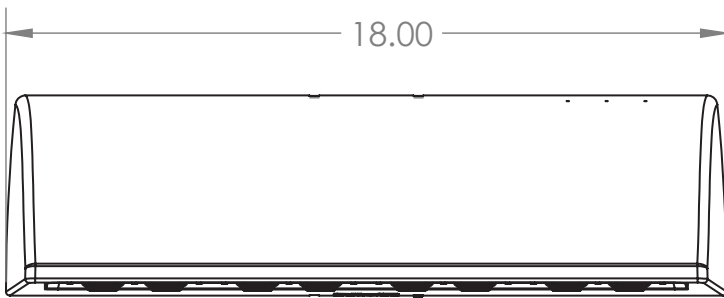
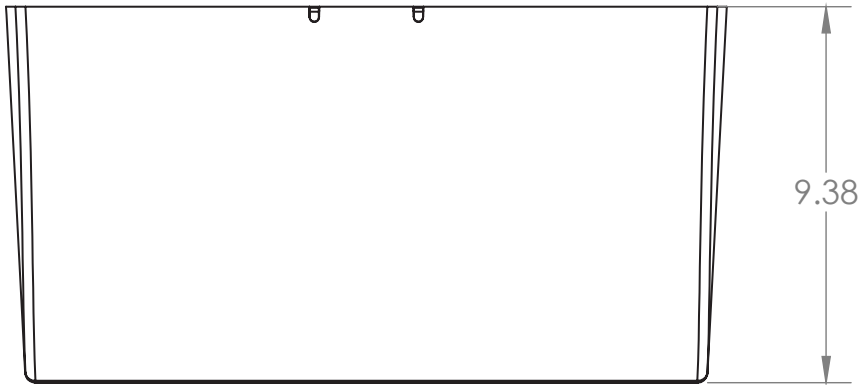

Weight: 16 lbs

PRODUCT SPECIFICATIONS

VANITY PLATE (VP)

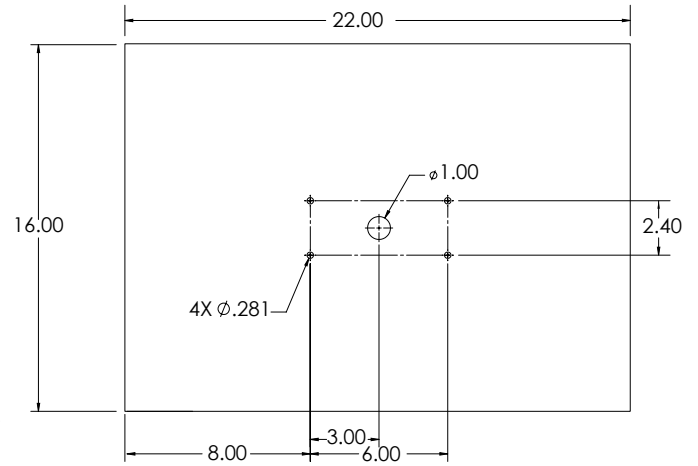
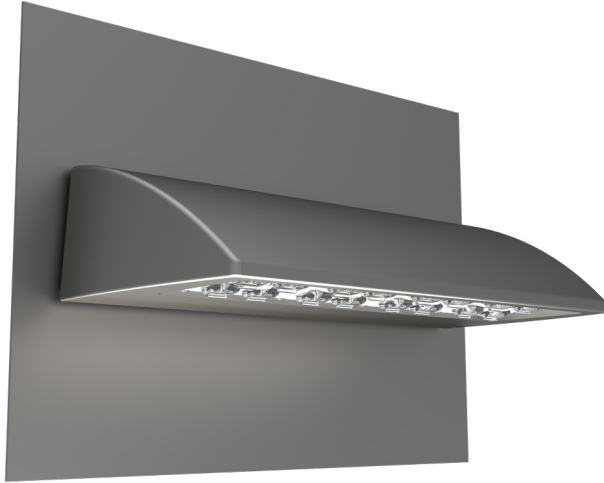

MOUNTING HOLE

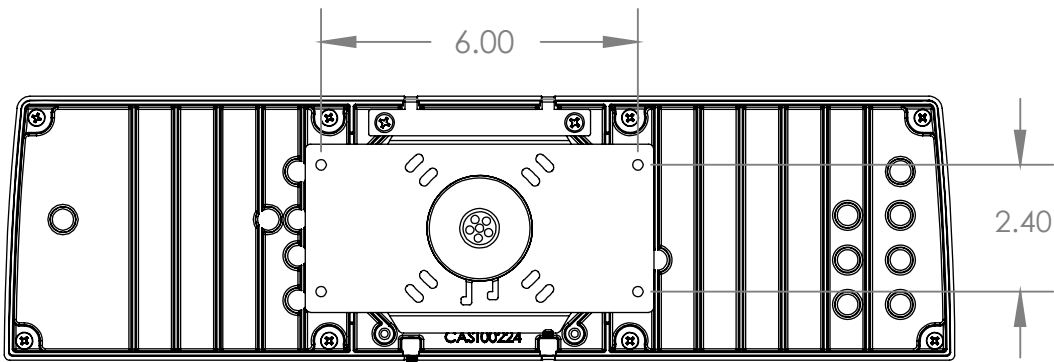

- * 3 Conduit access points on either side or center back.
- * Option to mount the bracket slots onto the J-box tabs

PRODUCT SPECIFICATIONS

CONDUIT BOX
3/4" NPT

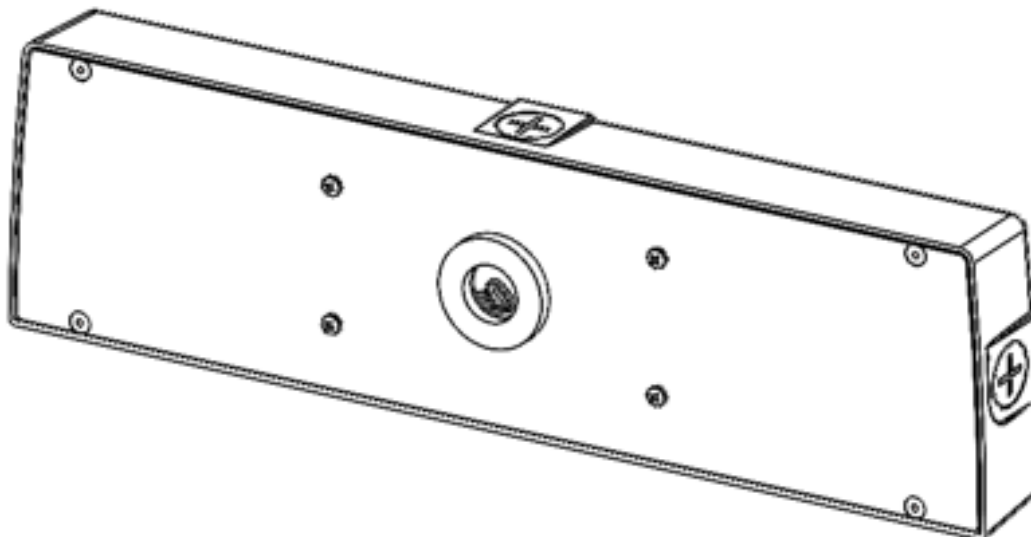

UP LIGHT

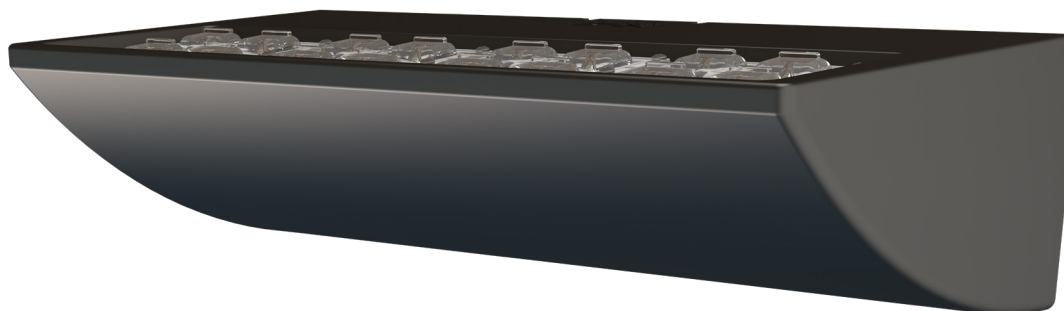

LUMENS

PART NUMBER	T2	LM/W	T3	LM/W	T4	LM/W	WATTS
NV-W2-64L-53-27K8	9345	94	9712	B2-U0-G2	9285	94	99
NV-W2-64L-53-27K7	9980	101	10372	B2-U0-G2	9915	100	99
NV-W2-64L-53-30K8	10020	101	10413	B2-U0-G2	9955	101	99
NV-W2-64L-53-30K7	10791	109	11215	B2-U0-G2	10722	108	99
NV-W2-64L-53-35K8	10020	101	10413	B2-U0-G2	9955	101	99
NV-W2-64L-53-40K8	10791	109	11215	B2-U0-G2	10722	108	99
NV-W2-64L-53-40K7	11660	118	12118	B2-U0-G2	11585	117	99
NV-W2-64L-53-50K8	10791	109	11215	B2-U0-G2	10722	108	99
NV-W2-64L-53-50K7	11660	118	12118	B2-U0-G2	11585	117	99
NV-W2-64L-7-27K8	12343	91	12828	B2-U0-G2	12263	90	136
NV-W2-64L-7-27K7	13181	97	13698	B3-U0-G3	13096	96	136
NV-W2-64L-7-30K8	13234	97	13753	B3-U0-G3	13148	97	136
NV-W2-64L-7-30K7	14253	105	14812	B3-U0-G3	14161	104	136
NV-W2-64L-7-35K8	13234	97	13753	B3-U0-G3	13148	97	136
NV-W2-64L-7-40K8	14253	105	14812	B3-U0-G3	14161	104	136
NV-W2-64L-7-40K7	15400	113	16005	B3-U0-G3	15301	113	136
NV-W2-64L-7-50K8	14253	105	14812	B3-U0-G3	14161	104	136
NV-W2-64L-7-50K7	15400	113	16005	B3-U0-G3	15301	113	136
NV-W2-64L-1-27K8	18515	90	19241	B3-U0-G3	18395	90	205
NV-W2-64L-1-30K7	19771	96	20547	B3-U0-G3	19644	96	205
NV-W2-64L-1-30K8	19850	97	20630	B3-U0-G3	19722	96	205
NV-W2-64L-1-30K7	21379	104	22218	B3-U0-G3	21241	104	205
NV-W2-64L-1-35K8	19850	97	20630	B3-U0-G3	19722	96	205
NV-W2-64L-1-40K8	21379	104	22218	B3-U0-G3	21241	104	205
NV-W2-64L-1-40K7	23100	113	24007	B3-U0-G3	22951	112	205
NV-W2-64L-1-50K8	21379	104	22218	B3-U0-G3	21241	104	205
NV-W2-64L-1-50K7	23100	113	24007	B3-U0-G3	22951	112	205

3000K or lower, with fixed mounting options only, must be selected to meet International Dark-Sky Association certification.

BUG RATINGS

PART NUMBER	T2	T3	T4	WATTS
NV-W2-64L-53-27K8	B1-U0-G2	B2-U0-G2	B2-U0-G2	99
NV-W2-64L-53-27K7	B2-U0-G2	B2-U0-G2	B2-U0-G2	99
NV-W2-64L-53-30K8	B2-U0-G2	B2-U0-G2	B2-U0-G2	99
NV-W2-64L-53-30K7	B2-U0-G2	B2-U0-G2	B2-U0-G2	99
NV-W2-64L-53-35K8	B2-U0-G2	B2-U0-G2	B2-U0-G2	99
NV-W2-64L-53-40K8	B2-U0-G2	B2-U0-G2	B2-U0-G2	99
NV-W2-64L-53-40K7	B2-U0-G2	B2-U0-G2	B2-U0-G2	99
NV-W2-64L-53-50K8	B2-U0-G2	B2-U0-G2	B2-U0-G2	99
NV-W2-64L-53-50K7	B2-U0-G2	B2-U0-G2	B2-U0-G2	99
NV-W2-64L-7-27K8	B2-U0-G2	B2-U0-G2	B2-U0-G2	136
NV-W2-64L-7-27K7	B2-U0-G2	B3-U0-G3	B2-U0-G2	136
NV-W2-64L-7-30K8	B2-U0-G2	B3-U0-G3	B2-U0-G2	136
NV-W2-64L-7-30K7	B2-U0-G2	B3-U0-G3	B2-U0-G2	136
NV-W2-64L-7-35K8	B2-U0-G2	B3-U0-G3	B2-U0-G2	136
NV-W2-64L-7-40K8	B2-U0-G2	B3-U0-G3	B2-U0-G2	136
NV-W2-64L-7-40K7	B3-U0-G3	B3-U0-G3	B3-U0-G3	136
NV-W2-64L-7-50K8	B2-U0-G2	B3-U0-G3	B2-U0-G2	136
NV-W2-64L-7-50K7	B2-U0-G2	B3-U0-G3	B3-U0-G3	136
NV-W2-64L-1-27K8	B2-U0-G2	B3-U0-G3	B2-U0-G2	205
NV-W2-64L-1-30K7	B3-U0-G3	B3-U0-G3	B3-U0-G3	205
NV-W2-64L-1-30K8	B3-U0-G3	B3-U0-G3	B3-U0-G3	205
NV-W2-64L-1-30K7	B3-U0-G3	B3-U0-G3	B3-U0-G3	205
NV-W2-64L-1-35K8	B3-U0-G3	B3-U0-G3	B3-U0-G3	205
NV-W2-64L-1-40K8	B3-U0-G3	B3-U0-G3	B3-U0-G3	205
NV-W2-64L-1-40K7	B3-U0-G3	B3-U0-G3	B3-U0-G4	205
NV-W2-64L-1-50K8	B3-U0-G3	B3-U0-G3	B3-U0-G3	205
NV-W2-64L-1-50K7	B3-U0-G3	B3-U0-G3	B3-U0-G4	205



701 Kingshill Place, Carson, CA 90746
 Call Us Today (310) 341-2037

nlsighting.com

EMERGENCY BATTERY BACK-UP LUMENS

PART NUMBER	T2	T3	T4	WATTS
EM14-27K7	1,287	1,299	1,287	13
EM14-30K7	1,396	1,409	1,396	13
EM14-35K8	1,208	1,221	1,208	13
EM14-40K7	1,467	1,482	1,467	13
EM14-50K7	1,467	1,482	1,467	13
EMCP-27K7	1,287	1,299	1,287	13
EMCP-30K7	1,396	1,409	1,396	13
EMCP-35K8	1,208	1,221	1,208	13
EMCP-40K7	1,467	1,482	1,467	13
EMCP-50K7	1,467	1,482	1,467	13

Lumen Maintenance Data

Ambient Temperature	Drive Current	L90 Hours*	L70 Hours**	30,000 Hours*	50,000 Hours*	60,000 Hours*	100,000 Hours**
25°C	Up to 700mA	58,000	173,000	95.7%	91.6%	89.6%	82.1%
	1050mA	48,000	143,000	94.3%	89.5%	87.2%	78.5%
*Reported extrapolations per IESNA TM-21				**Projected extrapolations per IESNA TM-21			