

Project Name:	Type:
Part Number:	Date:

PXCYL CYLINDER 2"

SPECIFICATION FEATURES

- **Mechanical** - Compact fixture body made from die cast aluminum. Super efficient extra diecast heat sink for long life lasting COB. Proprietary selectable output driver and polycarbonate lens and reflector design provide high quality light to compliment any spaces. Fixture bodies are available in matte black and matte white, or additional customized colors. Available in Surface, Pendant, Suspension cable, Wall mount or Track pendant configuration.
- **Electrical** - Two selectable lumen output driver options with SelectDrive technology. The 120V, 50/60 Hz driver is forward or reverse phase dimmable to 5%. The 120-277V, 50/60 Hz driver is 0-10V dimmable to 5% with a low end cutoff and comes with a 12V auxiliary port that provides power for field installed sensors and control modules. Static lumen output driver options include the Lutron 5-Series Ecosystem driver which provides smooth dimming to 5% and the Lutron Hi-Lume 1% EcoSystem driver with Soft-On, Fade-to-Black which dims to 1%. EldoLED ECOdrive and SOLOdrive drivers are available in 0-10V and DALi configurations and dim smoothly to 1% and 0.1% respectively.
- **Optical** - Self-flanged polycarbonate reflector. With 25° optical cutoff. Field interchangeable optical lenses. Four beam distributions range from 15° to 60°. COB LED binned to 2-step SDCM to ensure color uniformity in 2700K, 3000K, 3500K, 4000K or 5000K CCT. Minimum 90 CRI. 97 CRI with TRUE CHROMA available in 3000K only.
- **Thermal** - Die cast heat sink maximizes passive thermal management and achieves a L70 rated lifetime of 50,000+ hours. Ambient temperature rated from -22°F to 95°F (-30°C to 35°C).
- **Compliance and Warranty** - ETL Listed for damp location. Track pendant mounting suitable for dry location only. WET location available for Surface Mount and Wall Mount downlighting under covered ceiling. Complies with FCC 47CFR Part 15B consumer limits for EMI/RFI emissions. 5 year parts warranty for complete fixture. Optional 10 Year Extended Warranty available, subject to same terms, conditions and installation requirements as standard 5 Year Warranty.



060223



BENEFITS

- Get the right amount of light with SelectDrive technology
- Multiple finish and customization available to match any décor
- Surface, Pendant, Cable, Track Suspension, Down-wall and Up-wall mounting available
- Field interchangeable optics ensure smooth light levels
- Large variety of dimming and sensor control options

APPLICATIONS

- Retail
- Hospitality
- Residential
- Education
- Healthcare



PXCYL CYLINDER 2"

ORDERING INFORMATION

ORDERING EXAMPLE: PXCYL2/SM/LES9035/KDIM120V/MD/WH/CC

SelectDrive Light Engine

PXCYL	2	/	/	/	/	/	/	/	/	/
Model Series	Size	Mounting	Light Engine	CRI	CCT	Driver	Optical Distribution	Cylinder Finish	Reflector Finish	Options
<input type="checkbox"/> PXCYL PXCYL Cylinder	<input type="checkbox"/> 2 2"	<input type="checkbox"/> SM Surface Mount	<input type="checkbox"/> LES Small Light Engine 500-700-1000 lumens	<input type="checkbox"/> 90 CRI 90+	<input type="checkbox"/> 27 ^a 2700K	<input type="checkbox"/> KDIM120V SelectDrive 120V, 50/60Hz Forward/Reverse phase dimming	<input type="checkbox"/> SP Spot 15° Beam Angle	<input type="checkbox"/> WH Matte White	<input type="checkbox"/> CC Clear	<input type="checkbox"/> WET ⁶ Wet Location Ready
		<input type="checkbox"/> CM ¹ Cable Mount Ready		<input type="checkbox"/> 97 ^{3,4} 97 CRI 3000K TRUE CHROMA	<input type="checkbox"/> 30 3000K	<input type="checkbox"/> KDIM010UNV SelectDrive 120-277V, 50/60Hz 0-10V dimming	<input type="checkbox"/> VN Very Narrow 25° Beam Angle	<input type="checkbox"/> BL Matte Black	<input type="checkbox"/> WH White	For Emergency options please see field installable options below
		<input type="checkbox"/> PM ¹ Pendant Mount Ready			<input type="checkbox"/> 35 3500K		<input type="checkbox"/> NR Narrow 40° Beam Angle	<input type="checkbox"/> BZ ⁵ Bronze	<input type="checkbox"/> CZ ⁵ Customized	
		<input type="checkbox"/> TJPM ² Track J-Type Suspended Mount Ready			<input type="checkbox"/> 40 4000K		<input type="checkbox"/> MD Medium 60° Beam Angle	<input type="checkbox"/> SV ⁵ Silver		
		<input type="checkbox"/> WM Wall Mount			<input type="checkbox"/> 50 ^a 5000K			<input type="checkbox"/> CZ ⁵ Customized		
		<input type="checkbox"/> WMUP Wall Mount Up lighting								

Fixed Lumen Output Light Engine

PXCYL	2	/	/	/	/	/	/	/	/	/
Model Series	Size	Mounting	Light Engine	CRI	CCT	Driver	Optical Distribution	Cylinder Finish	Reflector Finish	Options
<input type="checkbox"/> PXCYL PXCYL Cylinder	<input type="checkbox"/> 2 2"	<input type="checkbox"/> SM Surface Mount	<input type="checkbox"/> LE05 ⁶ 500 lumens	<input type="checkbox"/> 90 CRI 90+	<input type="checkbox"/> 27 ^a 2700K	<input type="checkbox"/> XT010UNV 0-10V 1% Xitanium Driver, 120-277V	<input type="checkbox"/> SP ¹¹ Spot 15° Beam Angle	<input type="checkbox"/> WH Matte White	<input type="checkbox"/> CC Clear	<input type="checkbox"/> WET ⁶ Wet Location Ready
		<input type="checkbox"/> CM ¹ Cable Mount Ready	<input type="checkbox"/> LE07 700 lumens	<input type="checkbox"/> 97 ^{3,4} 97 CRI 3000K TRUE CHROMA	<input type="checkbox"/> 30 3000K	<input type="checkbox"/> LUT-1UNV Lutron EcoSystem 1% Dimming, 120-277V	<input type="checkbox"/> VN Very Narrow 25° Beam Angle	<input type="checkbox"/> BL Matte Black	<input type="checkbox"/> WH White	For Emergency options please see field installable options below
		<input type="checkbox"/> PM ¹ Pendant Mount Ready	<input type="checkbox"/> LE10 1,000 lumens		<input type="checkbox"/> 35 3500K	<input type="checkbox"/> ELD-E010UNV EldoLED ECOdrive 0-10V 1%, 120-277V	<input type="checkbox"/> NR Narrow 40° Beam Angle	<input type="checkbox"/> BZ ⁵ Bronze	<input type="checkbox"/> CZ ⁵ Customized	
		<input type="checkbox"/> TJPM ² Track J-Type Suspended Mount Ready	<input type="checkbox"/> LE15 1,500 lumens		<input type="checkbox"/> 40 4000K	<input type="checkbox"/> ELD-EDALIUNV EldoLED ECOdrive DALI 1%, 120-277V	<input type="checkbox"/> MD Medium 60° Beam Angle	<input type="checkbox"/> SV ⁵ Silver		
		<input type="checkbox"/> WM Wall Mount	<input type="checkbox"/> LE20 2,000 lumens		<input type="checkbox"/> 50 ^a 5000K	<input type="checkbox"/> ELD-S010UNV EldoLED SOLOdrive 0-10V 0.1%, 120-277V		<input type="checkbox"/> CZ ⁵ Customized		
		<input type="checkbox"/> WMUP Wall Mount Up lighting				<input type="checkbox"/> ELD-SDALIUNV EldoLED SOLOdrive DALI 0.1%, 120-277V				
						<input type="checkbox"/> OSRDIM010347V Osram OPTOTRONIC 0-10V 1%, 347V				

¹ Cable and Pendant Mount ready for Stem or Cable Suspension, Order Canopy type and length separately. ² Track cable type and length to be order separately. TJPM is only suitable for 120V power input. ³ True Chroma only available for 3000K, contact factory for detail and other CCT. ⁴ Non-stock item: may be subject to extended lead time and minimum order quantity. Please contact factory for details. ⁵ Please contact factory for silver, bronze and customized finish color or customized reflectors for feasibility and lead times. ⁶ WET location are available only for Surface Mounted and Wall Mount downlighting under covered ceiling. WET location is not compatible with any sensor options.



PXCYL CYLINDER 2"

MOUNTING AND CANOPY OPTIONS

CABLE MOUNTING KIT ORDERING EXAMPLE: CABLECPY/WH/50/18/3

CABLECPY/1-4			
Model Series	Color	Length ²	Cord Type
<input type="checkbox"/> CABLECPY/1-4¹ Cable mount canopy for flat and slope ceiling (use with CM mounting only)	<input type="checkbox"/> WH White	<input type="checkbox"/> 50 Adjustable length up to 50" max.	<input type="checkbox"/> 18/3 3 x 18 AWG, for non Dimming or TRIAC/ELV
	<input type="checkbox"/> BL Black	<input type="checkbox"/> 72 Adjustable length up to 72" max.	<input type="checkbox"/> 18/3-22/2 3 x 18 AWG, 2 x 22 AWG (purple, pink), for 0-10V control and dimming and/or to connect a field installable micro inverter (FHUPS1-UNV-25L-SD)
	<input type="checkbox"/> CZ³ Customized	<input type="checkbox"/> 100 Adjustable length up to 100" max.	<input type="checkbox"/> 18/4-22/2 4 x 18 AWG, 2 x 22 AWG, for emergency wiring with field installable EM driver (FHSCP-UNV-10.7WL(-CEC))
		<input type="checkbox"/> CZ³ Customized	



PENDANT MOUNTING KIT ORDERING EXAMPLE: STEMSCPY/1-4/WH/12/18/3

STEMSCPY/1-4			
Model Series	Color	Length ²	Cord Type
<input type="checkbox"/> STEMSCPY/1-4¹ Pendant stem Canopy (3/8 IPS) for flat and slope ceiling up to 45° (use with PM mounting only)	<input type="checkbox"/> WH White	<input type="checkbox"/> 12 12" long	<input type="checkbox"/> 18/3 3 x 18 AWG, for non Dimming or TRIAC/ELV
<input type="checkbox"/> STEMCDTFCCPY/1-4⁴ Jbox Cover Canopy for flat ceiling, with 4x side conduits pass through, for 1/4 IPS pendant stem	<input type="checkbox"/> BL Black	<input type="checkbox"/> 24 24" long	<input type="checkbox"/> 18/3-22/2 3 x 18 AWG, 2 x 22 AWG (purple, pink), for 0-10V control and dimming and/or to connect a field installable micro inverter (FHUPS1-UNV-25L-SD)
	<input type="checkbox"/> CZ³ Customized	<input type="checkbox"/> 36 36" long	<input type="checkbox"/> 18/4-22/2 4 x 18 AWG, 2 x 22 AWG, for emergency wiring with field installable EM driver (FHSCP-UNV-10.7WL(-CEC))
		<input type="checkbox"/> 48 48" long	
		<input type="checkbox"/> CZ³ Customized	



TRACK PENDANT MOUNTING KIT ORDERING EXAMPLE: TJPMADPT/J/WH/12/18/3

TJPMADPT/J			
Model Series	Color	Length ²	Cord Type
<input type="checkbox"/> TJPMADPT/J Track Pendant Adapter J-type	<input type="checkbox"/> WH White	<input type="checkbox"/> 12 12" long	
	<input type="checkbox"/> BL Black	<input type="checkbox"/> 24 24" long	
		<input type="checkbox"/> 36 36" long	
		<input type="checkbox"/> 48 48" long	
		<input type="checkbox"/> CZ³ Customized	



¹ The Stem and cable canopies can be used for both plane and slope ceiling. ² Cord length will be approximately 12" longer than cable or Stem.

³ Please contact factory for customized color and length. ⁴ Stem Conduit Canopy only available for flat ceiling.



PXCYL CYLINDER 2"

LINE DRAWINGS

SURFACE MOUNT

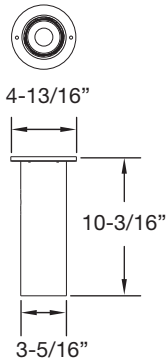

WALL MOUNT

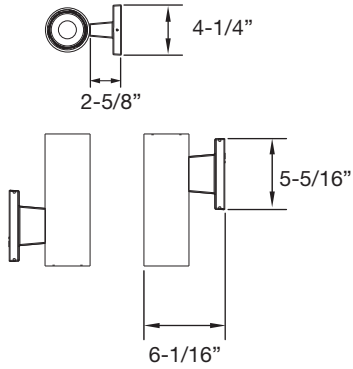

PENDANT

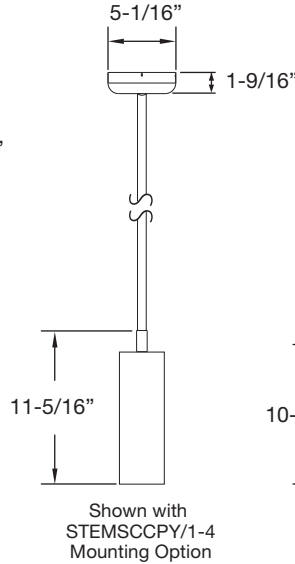

CABLE

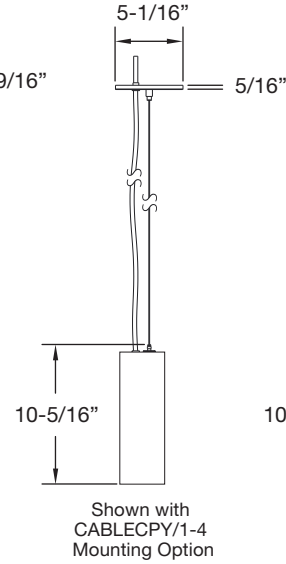

TRACK

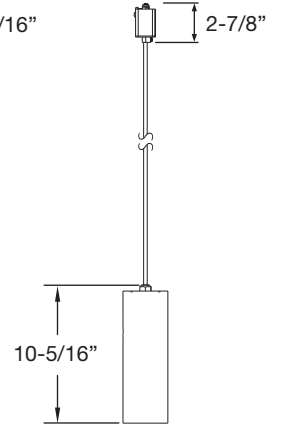

LINE DRAWINGS WITH MOUNTING ACCESSORIES

CONDUIT CANOPY PENDANT

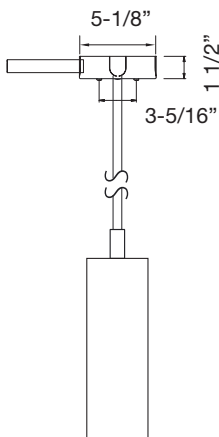

Shown with STEMCDTFCCPY/1-4 Mounting Option

CONDUIT CONFIGURATION OPTIONS

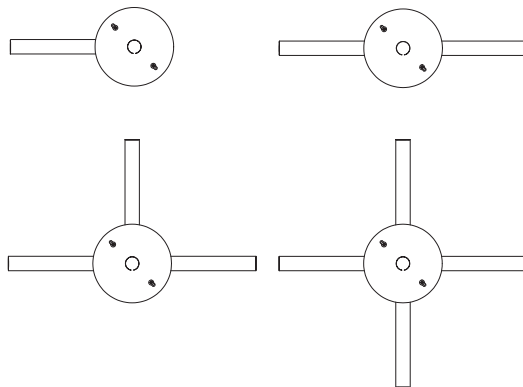

Up to four conduits. 3/4 trade size knockout (1-1/8"). Conduit Canopy Cover can also be ordered stand alone as an accessory to complete your project (please see accessory table)

FLANGELESS SURFACE MOUNT

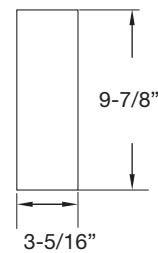

Shown in surface mounting configuration with PXCYL2-FLANGELESS SM KIT installed and finished ceiling

FLANGELESS SM KIT

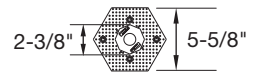



PXCYL CYLINDER 2"

ACCESSORY ORDERING INFORMATION

Product	Model	Description	Pictures	Dimensions
36761	CONDUITCPYKIT/WH	White finish, decorative Jbox cover, with 4 side conduit pass-through.		
36762	CONDUITCPYKIT/BL	Black finish, decorative Jbox cover, with 4 side conduit pass-through.		
35363	ORB/ACC/M/HC	Medium Honeycomb Louver		
61397	PXCYL2-FLANGELESS SM KIT	PXCYL2 Surface Mount Kit, Flangeless kit		

FIELD INSTALLABLE EMERGENCY UNIT ORDERING INFORMATION

Product	Model	Description	Picture	Dimension
FHUPS1-UNV-25L-SD	FHUPS1-UNV-25L-SD	25W Emergency Micro Inverter for field installation to use with 0-10V Driver options. 100-277VAC (up to 150W with use of 0-10V dimming). CEC Compliant.		
FHSCP-UNV-10.7WL	FHSCP-UNV-10.7WL	10.7W Emergency Driver for field installation to use with 120V and non 0-10V dimmable input Driver options. CEC Compliant.		

LINE DRAWINGS WITH OPTIONS

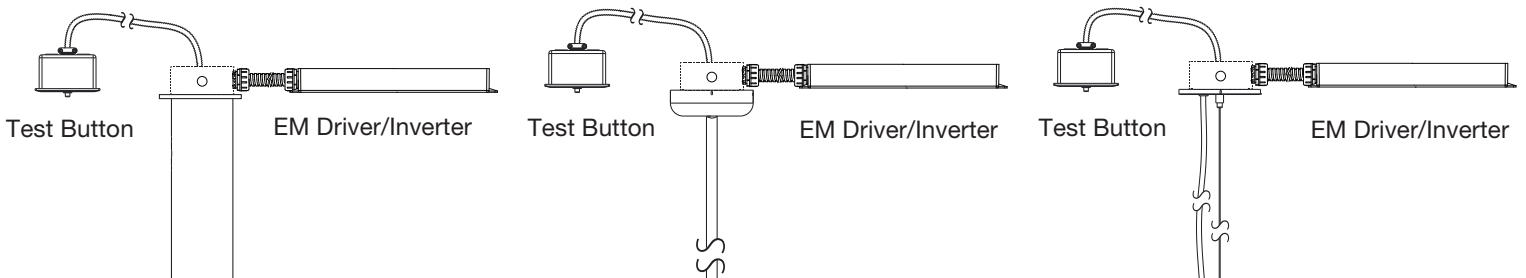

Field installable remote EM driver and Test button shown in surface mount installation. Electrical Box and Single gang j-box by others.

Field installable remote EM driver and Test button shown in Pendant Mount installation. Need to be use with 18-3/2-22 Type cord for FHUPS1-UNV-25L-SD or 18-4/22-2 for FHSCP-UNV-10.7WL/FHSCP-UNV-10.7WL-CEC Electrical Box and Single gang j-box by others.

Field installable remote EM driver and Test button shown in Cable Mount installation. Need to be use with 18-3/2-22 Type cord for FHUPS1-UNV-25L-SD or 18-4/22-2 for FHSCP-UNV-10.7WL/FHSCP-UNV-10.7WL-CEC Electrical Box and Single gang j-box by others.



PXCYL CYLINDER 2"

FHUPS1-UNV-25L-SD FIELD WIRING DIAGRAM INSTALLATION

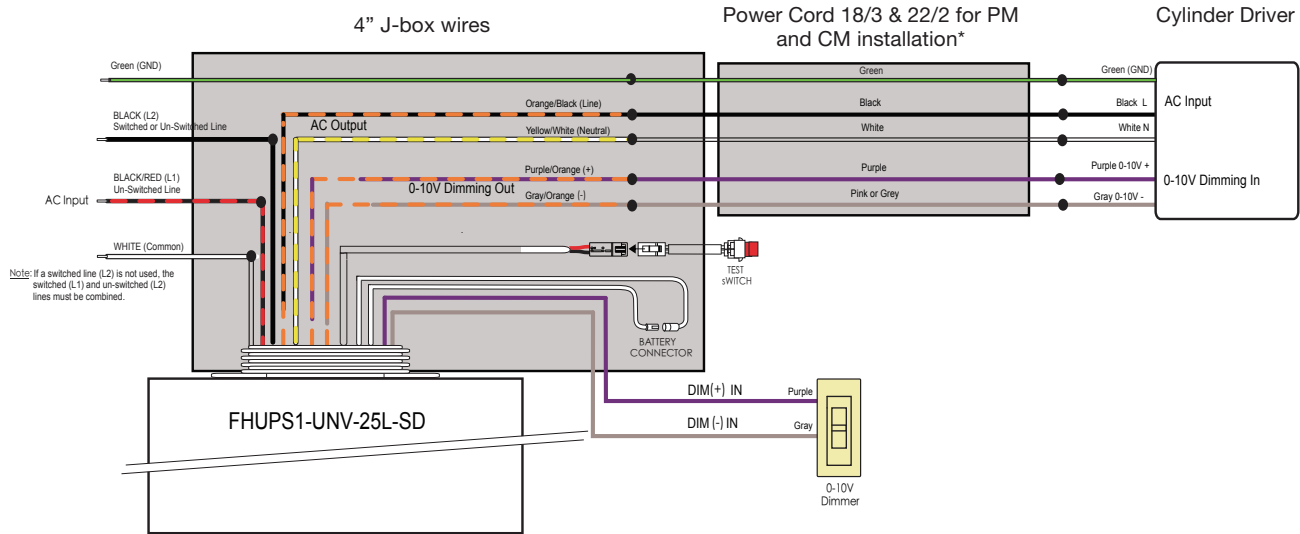

*For SM installation power cord is not needed connect the EM driver directly to the Driver.

FHSCP-UNV-10.7WL(-CEC) FIELD WIRING DIAGRAM INSTALLATION

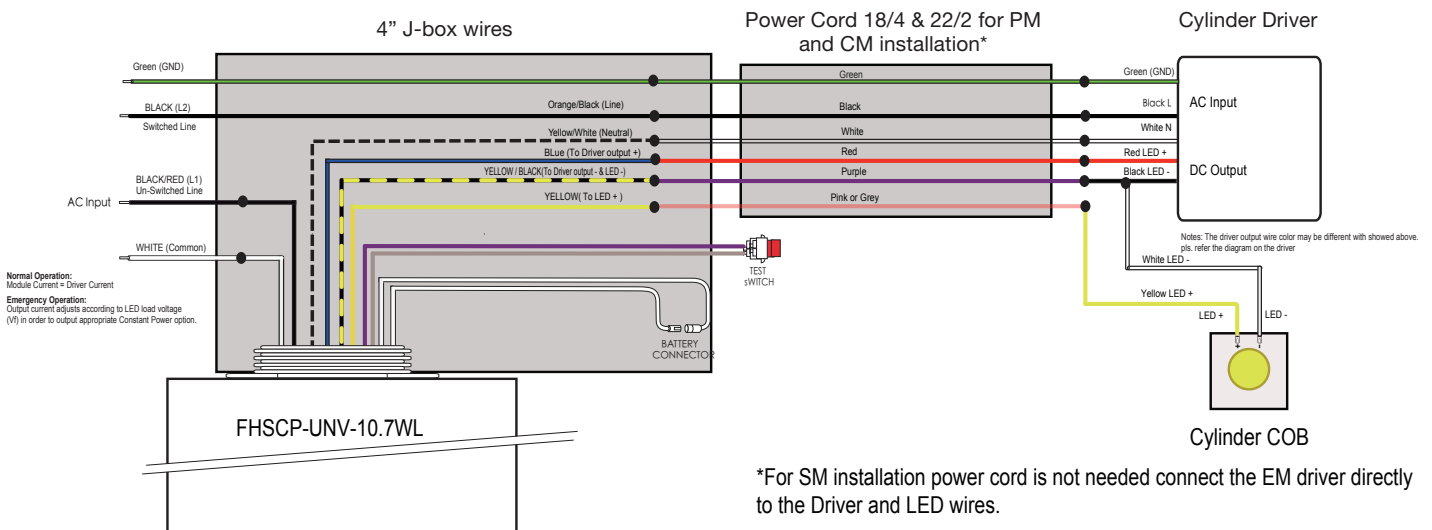

*For SM installation power cord is not needed connect the EM driver directly to the Driver and LED wires.

TECHNICAL INFORMATION

Light Engine	Input Voltage	Input Frequency	Input Current	Max. Input Power	THD Power	Power Factor
LES	120-277V	50-60Hz	0.115 / 0.047A	13W	<20%	>0.9
LE05			0.056 / 0.024A	6.5W		
LE07			0.073 / 0.034A	8.5W		
LE10			0.112 / 0.047A	13W		
LE15			0.154 / 0.068A	18W		
LE20			0.218 / 0.092A	25.5W		



PXCYL CYLINDER 2"

NOMINAL PERFORMANCE

LES (LE05 / LE07 / LE10) - Low / Medium / High - 6.5 / 8.5 / 12.5W

CCT	2700K			3000K			3500K			4000K			5000K								
Output**	Low	Medium	High	Low	Medium	High	Low	Medium	High	Low	Medium	High	Low	Medium	High						
Finish	lm	LPW	lm LPW	lm	LPW	lm LPW	lm	LPW	lm LPW	lm	LPW	lm LPW	lm	LPW	lm LPW						
Clear Diffuse	500	77	700 82	1,000	80	525 81	735 86	1,050	84	550 85	770 91	1,100	88	575 88	805 95	1,150	92	580 89	810 95	1,165	93
White Finish	500	77	700 82	1,000	80	525 81	735 86	1,050	84	550 85	770 91	1,100	88	575 88	805 95	1,150	92	580 89	810 95	1,165	93

LEM (LE15 / LE20) - Low / Medium - 18.0 / 25.5W

CCT	2700K				3000K				3500K				4000K				5000K			
Output**	LE15	LE20	LE15	LE20	LE15	LE20	LE15	LE20	LE15	LE20	LE15	LE20	LE15	LE20	LE15	LE20	LE15	LE20	LE15	LE20
Finish	lm	LPW	lm	LPW	lm	LPW	lm	LPW	lm	LPW	lm	LPW	lm	LPW	lm	LPW	lm	LPW	lm	LPW
Clear Diffuse	1,600	89	2,125	83	1,632	91	2,169	85	1,664	92	2,210	87	1,696	94	2,253	88	1,713	95	2,275	89
White Finish	1,600	89	2,125	83	1,632	91	2,169	85	1,664	92	2,210	87	1,696	94	2,253	88	1,713	95	2,275	89

** Lumen output are based on rated lumens, for exact value please refer to the IES files

PHOTOMETRY

PXCYL2/xx/LES9035/KDIM010UNV/SP/xx/CC (High Output)

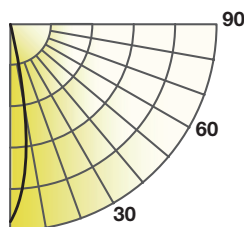

Lumens: 1,343 lm
CBCP: 14,066 cd
Power: 13 W
Efficacy: 112 lm/W
CRI: 92
Spacing Criteria: 0.3
Beam Angle: 15°

Candlepower Distribution	
Angle (°)	Average (cd)
10	436
20	37
30	7
40	3
50	2
60	0
70	0
80	0
90	0

Initial Footcandles		
Height (ft)	Fc	Diameter (ft)
8	10	2
10	6	3
12	4	3
15	3	4
20	2	5

Zonal Lumen Summary		
Zone	Lumens	%Fixt
0-30	1,290	96
0-40	1,318	98
0-60	1,341	100
0-90	1,343	100

PXCYL2/xx/LES9035/KDIM010UNV/VN/xx/CC (High Output)

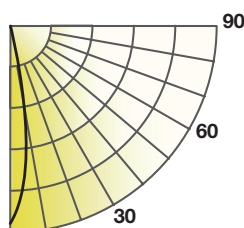

Lumens: 1,365 lm
CBCP: 7,197 cd
Power: 13 W
Efficacy: 114 lm/W
CRI: 92
Spacing Criteria: 0.4
Beam Angle: 23°

Candlepower Distribution	
Angle (°)	Average (cd)
10	4,329
20	749
30	101
40	46
50	18
60	6
70	0
80	0
90	0

Initial Footcandles		
Height (ft)	Fc	Diameter (ft)
8	101	3
10	64	4
12	45	5
15	29	6
20	16	8

Zonal Lumen Summary		
Zone	Lumens	%Fixt
0-30	1,280	94
0-40	1,331	98
0-60	1,362	100
0-90	1,364	100



PXCYL CYLINDER 2"

PHOTOMETRY

PXCYL2/xx/LES9035/KDIM010UNV/NR/xx/CC (High Output)

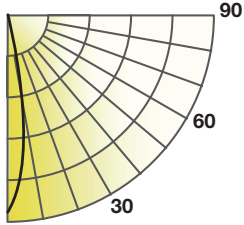

Lumens: 1,346 lm
CBCP: 4,379 cd
Power: 13 W
Efficacy: 112 lm/W
CRI: 92
Spacing Criteria: 0.5
Beam Angle: 33°

Candlepower Distribution	
Angle (°)	Average (cd)
10	3,543
20	1,278
30	152
40	32
50	16
60	4
70	0
80	0
90	0

Initial Footcandles		
Height (ft)	Fc	Diameter (ft)
8	82	5
10	53	6
12	37	7
15	23	9
20	13	12

Zonal Lumen Summary		
Zone	Lumens	%Fixt
0-30	1,276	95
0-40	1,318	98
0-60	1,344	100
0-90	1,346	100

PXCYL2/xx/LES9035/KDIM010UNV/MD/xx/WH (High Output)

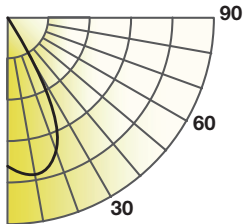

Lumens: 1,323 lm
CBCP: 1,580 cd
Power: 13 W
Efficacy: 110 lm/W
CRI: 92
Spacing Criteria: 0.87
Beam Angle: 59°

Candlepower Distribution	
Angle (°)	Average (cd)
10	1,524
20	1,301
30	751
40	108
50	22
60	6
70	2
80	0
90	0

Initial Footcandles		
Height (ft)	Fc	Diameter (ft)
8	35	9
9	28	10
10	23	11
12	16	13
15	10	17

Zonal Lumen Summary		
Zone	Lumens	%Fixt
0-30	1,028	78
0-40	1,273	96
0-60	1,316	100
0-90	1,322	100

Note: All rights reserved. All sizes and specifications are subject to change at any time without notice.